



3 EQUIPAMIENTO PARA BARES
BAR EQUIPMENT



CORECO



BOTELLEROS - CHEST COOLER

Pag. **94-95**

Enfriador de botellas
Chest bottle cooler

Pag. **96-97**

Enfriador de botellas, fondo plano, brazos rectos
Chest bottle cooler, front angle



BACK BAR

Pag. **98-99**

Expositor refrigerado horizontal VINOS
BACK-BAR WINE display cooler

Pag. **100-101**

Expositor refrigerado horizontal
BACK-BAR display cooler

Pag. **102-103**

Mostrador refrigerado horizontal
BACK-BAR cooler



SNACK BAR

Pag. **104-113**

Frente mostrador refrigerado SNACK-BAR
SNACK-BAR cooler



ESCARCHADORES - GLASS FROSTER

Pag. **114**

ESCARCHADOR de copas
GLASS-FROSTER

Pag. **115**

Departamentos PESCADO, mantenimiento CONGELADOS
FISH, FREEZER department



EXPOSITORES VERTICALES - MERCHANDISERS

Pag. **116**

Expositor refrigerado sobre-mostrador
On counter merchandiser

Pag. **119**

Expositor refrigerado vertical
Merchandiser

Pag. **120-121**

Expositor refrigerado GOURMET
GOURMET Merchandiser

Pag. **122-123**

Expositor refrigerado MINIMARKET
MINIMARKET Merchandiser



BARRILEROS - KEG COOLERS

Pag. **124-125**

Enfriador de barriles
Kegs coolers



ENFRIADORES DE AGUA

Pag. **126-127**

TANQUE enfriador de agua
Water coolers



BE-100-I 852 €

 BE-150-I 1.121 €
 BE-150-A 990 €

 BE-200-I 1.305 €
 BE-200-A 1.168 €

 BE-250-I 1.610 €
 BE-250-A 1.441 €

BE-300-I 2.052 €



BE-100-EA 684 €



BE-150-EA 905 €



BE-200-EA 1.078 €

mod.	rango range °C	largo length (mm)	alto height (mm)	fondo depth (mm)	puertas doors	separador shelves	capacidad capacity (L)	voltaje voltage	refrigerante refrigerant	potencia frig. frig. power W	potencia power W
BE-100	+2°C +8°C	1010	850	550	2	1	270	230V-50Hz	R134a*	140	150
									R600a	176	125
BE-150	+2°C +8°C	1500	850	550	3	2	420	230V-50Hz	R134a*	304	247
									R600a	205	126
BE-200	+2°C +8°C	1990	850	550	4	3	580	230V-50Hz	R134a*	304	258
									R600a	304	184
BE-250	+2°C +8°C	2480	850	550	5	4	720	230V-50Hz	R134a*	485	389
									R290	502	208
BE-300	+2°C +8°C	2970	850	550	6	5	860	230V-50Hz	R134a*	485	400
									R290	533	244

*opcional - optional

Características técnicas y constructivas sujetas a variación sin previo aviso.

BE-I

- Exterior en acero inox AISI-304, excepto el respaldo
- Interior en acero inox AISI-304

BE-A

- Exterior en acero inox AISI-304, excepto el respaldo
- Interior en aluminio

BE-EA

- Exterior en acero plastificado blanco, excepto el respaldo
- Interior en acero galvanizado

CARACTERISTICAS COMUNES

- Puertas inox deslizantes sobre bastidor
- Encimera de acero inox AISI-304
- Separadores interiores en alambre de acero plastificado
- Aislamiento de poliuretano inyectado, densidad 40 Kg/m³, cero efectos ODP y GWP
- Evaporador estático
- Unidad condensadora ventilada y extraíble
- Control mecánico de temperatura, digital con pantalla, en opción.
- Temperatura de trabajo a 32°C ambiente

OPCIONES	OPTIONS	€
set 4 ruedas	4 castors set	80 € x set
set 6 ruedas	6 castors set	120 € x set
cambio R134a por R600a	R134a to R600a	0 €
cambio R134a por R290	R134a to R290	0 €
motor lado izquierdo	left side engine	60 €
control digital con pantalla	digital control with display	95 €
230v 60Hz / 115v 60Hz	230v 60Hz / 115v 60Hz	consultar - consult
puerta con cerradura	door with lock	40 x ud

We reserve the right to change specifications without prior notice.

BE-I

- AISI-304 stainless steel exterior, rear side galvanized panel
- AISI-304 stainless steel interior

BE-A

- AISI-304 stainless steel exterior, rear side galvanized panel
- Aluminium interior

BE-EA

- Plasticized exterior, rear side galvanized panel
- Interior in galvanized steel

FEATURES IN COMMON

- Stainless steel sliding doors
- AISI-304 stainless steel worktop
- Plasticized steel wire internal dividers
- 40 Kg/m³ density polyurethane insulation, zero ODP and GWP
- Static evaporator
- Removable and fan assisted condenser unit
- Mechanic control of temperature, digital with display as optional
- Operating temperature, 32°C ambient

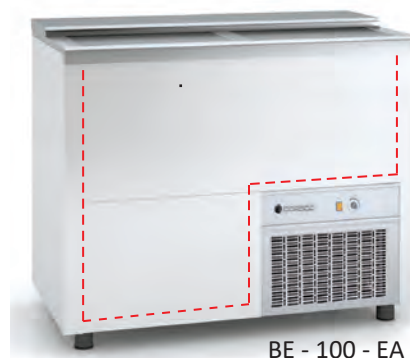
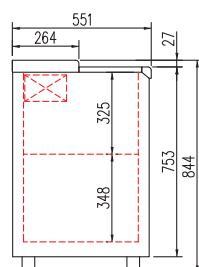
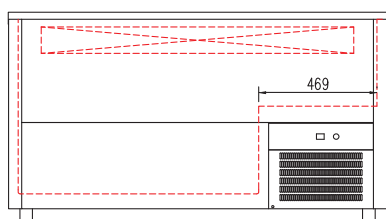

BE - 100 - EA

all photos must be considered as a reference - fotografías no contractuales



BE-200



BE-150-EA

Puerta con cerradura opcional
Door with lock on demand

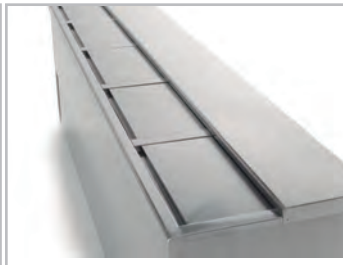
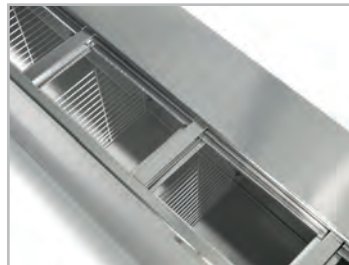



BEG-70-EA	463 €
BEG-70-EI	509 €



BEG-100-EA	535 €
BEG-100-EI	581 €



BEG-150-EA	721 €
BEG-150-EI	787 €



BEG-200-EA	839 €
BEG-200-EI	937 €



BEG-70-I	550 €
----------	-------



BEG-100-I	644 €
-----------	-------



BEG-150-I	875 €
-----------	-------



BEG-200-I	1.065 €
-----------	---------

mod.	rango range °C	largo length (mm)	alto height (mm)	fondo depth (mm)	puertas doors	separador shelves	capacidad capacity (L)	voltaje voltage	refrigerante refrigerant	potencia frig. frig. power W	potencia power W
BEG-70	+2°C +8°C	705	835	540	1	0	110	230V-50Hz	R600a	144	66
BEG-100	+2°C +8°C	1020	835	540	2	1	170	230V-50Hz	R600a	176	137
BEG-150	+2°C +8°C	1510	835	540	3	2	260	230V-50Hz	R600a	176	137
BEG-200	+2°C +8°C	2030	835	540	4	3	350	230V-50Hz	R600a	250	187

Características técnicas y constructivas sujetas a variación sin previo aviso.

BEG-I:

- Frente exterior y costados en acero AISI-304
- Respaldo exterior en acero galvanizado
- Interior en acero AISI-304

BEG-EI:

- Frente exterior y costados en acero plastificado color blanco
- Respaldo exterior en acero galvanizado
- Interior en acero AISI-304

BEG-EA:

- Frente exterior y costados en acero plastificado color blanco
- Respaldo exterior en acero galvanizado
- Interior en acero galvanizado

CARACTERISTICAS COMUNES

- Estantes interiores de alambre en acero plastificado.
- Unidad condensadora ventilada y extraíble.
- Aislamiento de poliuretano inyectado, densidad 40 Kg/m³, cero efectos ODP y GWP.
- Evaporador estático.
- Control de temperatura.
- Interruptor general ON - OFF luminoso.
- Temperatura de trabajo a 32°C temperatura ambiente.

We reserve the right to change specifications without prior notice.

BEG-I:

- AISI-304 exterior front and sides
- Rear side galvanized panel
- AISI-304 interior

BEG-EI:

- Exterior front and sides white plastic coated steel
- Rear side galvanized panel
- AISI-304 interior

BEG-EA:

- Exterior front and sides white plastic coated steel
- Rear side galvanized panel
- Galvanized interior

FEATURES IN COMMON

- Plasticized steel wire internal dividers.
- Ventilated, pull-out condenser unit.
- 40 Kg/m³ density polyurethane insulation, zero ODP and GWP
- Static evaporator.
- Temperature control.
- Luminous main switch ON - OFF.
- Working temperature, 32° ambient temperature.

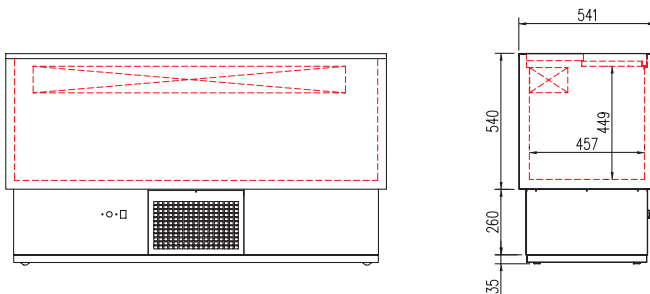

OPCIONES	OPTIONS	€
230v 60Hz / 115v 60Hz	230v 60Hz / 115v 60Hz	consultar - consult

BEG-70-EA

all photos must be considered as a reference - fotografías no contractuales



BEG-100-EA



BEG-150-I



BEG-200-EA

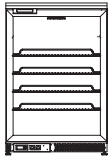

ERHW-150 902 €



ERHW-250 1.184 €

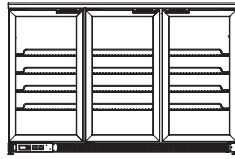

ERHW-350 1.462 €

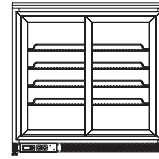

ERHWS-250 1.195 €

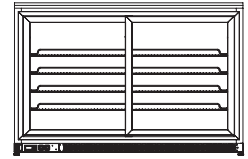

ERHWS-350 1.547 €

mod.	rango range °C	largo length (mm)	alto height (mm)	fondo depth (mm)	puertas abatibles hinged doors	puertas correderas sliding doors	capacidad botellas bottles capacity	voltaje voltage	refrigerante refrigerant	potencia frig. frig. power W	potencia power W
ERHW-150	+2°C +18°C	620	850	520	1	0	24	230V-50Hz	R134a*	140	179
									R600a	205	161
ERHW-250	+2°C +18°C	925	850	520	2	0	44	230V-50Hz	R134a*	304	321
									R600a	418	260
ERHW-350	+2°C +18°C	1375	850	520	3	0	68	230V-50Hz	R134a*	330	330
									R600a	418	264
ERHWS-250	+2°C +18°C	925	850	520	0	2	44	230V-50Hz	R134a*	304	321
									R600a	418	260
ERHWS-350	+2°C +18°C	1375	850	520	0	2	68	230V-50Hz	R134a*	330	330
									R600a	418	264

*opcional - optional

Características técnicas y constructivas sujetas a variación sin previo aviso.

We reserve the right to change specifications without prior notice.

ERHW

- Exterior en acero plastificado negro - Interior en acero plastificado gris
- Doble cristal sobre marco abatible, con cerradura de serie

ERHWS

- Exterior en acero plastificado negro
- Interior en acero plastificado gris
- Doble cristal sobre marco deslizante, con cerradura opcional

CARACTERISTICAS COMUNES

- Diseñados para botellas de vino
- Estantes de alambre de acero plastificado, regulables en altura
- Compresor hermético alto par de arranque
- Evaporador sistema tiro forzado, con recubrimiento epoxi anticorrosión
- Control digital de temperatura, descarches optimizados, alarma por alta temperatura de condensación. Eficiente gestión del consumo de energía
- Unidad condensadora ventilada libre de mantenimiento
- Aislamiento de poliuretano inyectado, densidad 40 Kg/m³, bajo GWP y cero efecto ODP
- Evaporación automática del agua de descarche
- Temperatura de trabajo +4°C +18°C a 32°C ambiente
- Tensión monofásica 230V - 50 Hz

ERHW

- Anthracite plastic coated steel exterior
- Interior gray plastic coated steel
- Double glass on folding frame with lock as standard

ERHWS

- Anthracite plastic coated steel exterior
- Interior gray plastic coated steel
- Double glass on sliding frame with optional lock

FEATURES IN COMMON

- Designed for bottled wine
- Steel wire shelves adjustable plastic height
- Hermetic compressor higher starting torque
- Forced draft evaporator system with anticorrosion coating
- Digital temperature control, optimized defrost, high-temperature condensation alarm. Efficient management of energy consumption
- Ventilated condensing unit (free condenser maintenance)
- Isolation of polyurethane, density 40 Kg / m³, zero ODP and GWP
- Automatic evaporation of defrost water
- Operating temperature +4°C +18° 32°C ambient
- Voltage 230V - 50 Hz

OPCIONES	OPTIONS	€
ERHWS cerradura	ERHWS lock	50 €
230v 60Hz / 115v 60Hz	230v 60Hz / 115v 60Hz	consultar - consult
cambio R600a por R134a	R600a to R134a	0 €

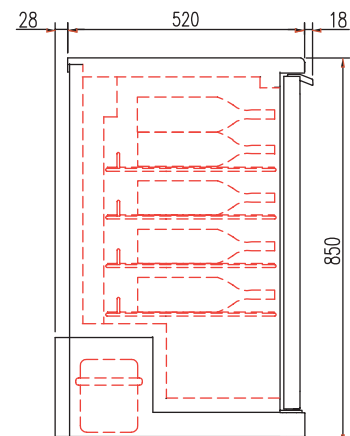

all photos must be considered as a reference - fotografías no contractuales

+18°C
+2°C



ERHW-150



ERHWS-250



mod.	rango range °C	largo length (mm)	alto height (mm)	fondo depth (mm)	puertas abatibles hinged doors	puertas correderas sliding doors	estantes shelves	capacidad latas cans capacity (33 cl.)	voltaje voltage	refrigerante refrigerant	potencia frig. frig. power W	potencia power W
ERH-150-L	+2°C +8°C	620	850	520	1	0	2	150	230V-50Hz	R134a* R600a	140 205	179 161
ERH-250-L	+2°C +8°C	925	850	520	2	0	2	225	230V-50Hz	R134a* R600a	304 418	321 260
ERH-350-L	+2°C +8°C	1375	850	520	3	0	2	320	230V-50Hz	R134a* R600a	330 418	330 264
ERHS-250-L	+2°C +8°C	925	850	520	0	2	2	225	230V-50Hz	R134a* R600a	304 418	321 260
ERHS-350-L	+2°C +8°C	1375	850	520	0	2	2	320	230V-50Hz	R134a* R600a	330 418	330 264

*opcional - optional

Características técnicas y constructivas sujetas a variación sin previo aviso.

We reserve the right to change specifications without prior notice.

ERH-L

- Exterior en acero plastificado negro
- Interior en acero plastificado gris
- Doble cristal sobre marco abatible, con cerradura de serie

ERHS-L

- Exterior en acero plastificado negro
- Interior en acero plastificado gris
- Doble cristal sobre marco deslizante, con cerradura opcional

ERH-LI, ERHS-LI

- Exterior en acero inoxidable
- Interior en acero plastificado gris

ERH-L

- Anthracite plastic coated steel exterior
- Interior gray plastic coated steel
- Double glass on folding frame with lock as standard

ERHS-L

- Anthracite plastic coated steel exterior
- Interior gray plastic coated steel
- Double glass on sliding frame with optional lock

ERH-LI, ERHS-LI

- Stainless steel exterior
- Interior gray plastic coated steel

CARACTERISTICAS COMUNES

- Diseñados para bebidas y productos envasados
- Estantes de alambre de acero plastificado, regulables en altura
- Compresor hermético alto par de arranque
- Evaporador sistema tiro forzado, con recubrimiento epoxi anticorrosión
- Control digital de temperatura, descarches optimizados, alarma por alta temperatura de condensación. Eficiente gestión del consumo de energía
- Iluminación interior LEDs
- Unidad condensadora libre de mantenimiento
- Aislamiento de poliuretano inyectado, densidad 40 Kg/m³, bajo GWP y cero efecto ODP
- Evaporación automática del agua de descarche
- Temperatura de trabajo a 32°C ambiente
- Tensión monofásica 230V - 50 Hz

FEATURES IN COMMON

- Designed for beverages and packaged products
- Steel wire shelves adjustable plastic height
- Hermetic compressor higher starting torque
- Forced draft evaporator system with anticorrosion coating
- Digital temperature control, optimized defrost, high-temperature condensation alarm. Efficient management of energy consumption
- Interior LEDs lighting
- Fan assisted, maintenance free condenser
- Isolation of polyurethane, density 40 Kg / m³, zero ODP and GWP
- Automatic evaporation of defrost water
- Operating temperature 32°C ambient
- Voltage 230V - 50 Hz

OPCIONES	OPTIONS	€
ERHS cerradura	ERHS lock	50 €
230v 60Hz / 115v 60Hz		consultar - consult
cambio R600a por R134a	R600a to R134a	0 €
estante chapa perforada 150	150 SS shelf	65 € x ud
estante chapa perforada 250	250 SS shelf	75 € x ud
estante chapa perforada 350	350 SS shelf	85 € x ud

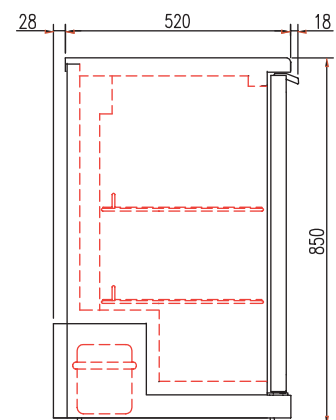

all photos must be considered as a reference - fotografías no contractuales



ERH-150-L



ERHS-250-L



ERH-350-LI



ERH-250-LI

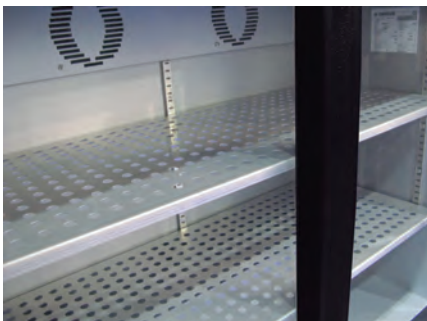

Estantes chapa perforada opcional
SS shelves on demand



ERH-350-LI



NRH-150-L 747 €



NRH-250-L 987 €



NRH-350-L 1.207 €



NRH-150-LI 832 €



NRH-250-LI 1.174 €



NRH-350-LI 1.457 €

mod.	rango range °C	largo length (mm)	alto height (mm)	fondo depth (mm)	puertas abatibles hinged doors	estantes shelves	capacidad latas cans capacity (33 cl.)	voltaje voltage	refrigerante refrigerant	potencia frig. frig. power W	potencia power W
NRH-150-L	+2°C +8°C	620	850	520	1	2	150	230V-50Hz	R134a*	140	179
									R600a	205	161
NRH-250-L	+2°C +8°C	925	850	520	2	2	225	230V-50Hz	R134a*	304	321
									R600a	418	260
NRH-350-L	+2°C +8°C	1375	850	520	3	2	320	230V-50Hz	R134a*	330	330
									R600a	418	264

*opcional - optional

Características técnicas y constructivas sujetas a variación sin previo aviso.

We reserve the right to change specifications without prior notice.

NRH-L

- Exterior en acero plastificado negro
- Interior en acero plastificado gris

NRH-LI

- Exterior en acero inoxidable
- Interior en acero plastificado gris

CARACTERISTICAS COMUNES

- Diseñados para bebidas y productos envasados
- Encastrables
- Estantes de alambre de acero plastificado, regulables en altura
- Compresor hermético alto par de arranque
- Evaporador sistema tiro forzado, con recubrimiento epoxi anticorrosión
- Control digital de temperatura, descarches optimizados, alarma por alta temperatura de condensación. Eficiente gestión del consumo de energía
- Unidad condensadora ventilada libre de mantenimiento
- Aislamiento de poliuretano inyectado, densidad 40 Kg/m³, bajo GWP y cero efecto ODP
- Evaporación automática del agua de descarche
- Temperatura de trabajo +2°C +8°C a 32°C ambiente
- Tensión monofásica 230V - 50 Hz

NRH-L

- Anthracite plastic coated steel exterior
- Interior gray plastic coated steel

NRH-LI

- Stainless steel exterior
- Interior gray plastic coated steel

FEATURES IN COMMON

- Designed for beverages and packaged products
- "Built-in" designed
- Steel wire shelves adjustable plastic height
- Hermetic compressor higher starting torque
- Forced draft evaporator system with anticorrosion coating
- Digital temperature control, optimized defrost, high-temperature condensation alarm. Efficient management of energy consumption
- Fan assisted, maintenance free condenser
- Isolation of polyurethane, density 40 Kg / m³, zero ODP and GWP
- Automatic evaporation of defrost water
- Operating temperature +2°C +8°C to 32°C ambient
- Voltage 230V - 50 Hz

OPCIONES	OPTIONS	€
230v 60Hz / 115v 60Hz	230v 60Hz / 115v 60Hz	consultar- consult
cambio R600a por R134a	R600a to R134a	0 €
estante chapa perforada 150	150 SS shelf	65 € x ud
estante chapa perforada 250	250 SS shelf	75 € x ud
estante chapa perforada 350	350 SS shelf	85 € x ud

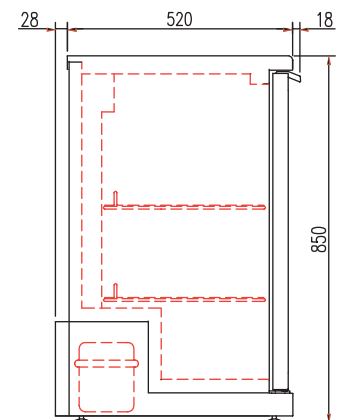

all photos must be considered as a reference - fotografías no contractuales



NRH-350-LI



NRH-250-LI



SBE-150 1.778 €



SBE-200 2.204 €



SBE-250 2.637 €



SBIE-150 1.842 €



SBIE-200 2.284 €



SBIE-250 2.726 €

mod.	rango range °C	largo length (mm)	alto height (mm)	fondo depth (mm)	estantes shelves	capacidad latas cans capacity (33 cl.)	capacidad capacity (L)	voltaje voltage	refrigerante refrigerant	potencia frig. frig. power W	potencia power W
SBE/SBIE-150	+2°C +8°C	1465	820-880	530	4	320	325	230V-50Hz	R134a*	380	496
									R290	845	420
SBE/SBIE-200	+2°C +8°C	2005	820-880	530	6	500	490	230V-50Hz	R134a*	485	504
									R290	845	427
SBE/SBIE-250	+2°C +8°C	2545	820-880	530	8	680	650	230V-50Hz	R134a*	515	509
									R290	845	433

*opcional - optional

Características técnicas y constructivas sujetas a variación sin previo aviso.

We reserve the right to change specifications without prior notice.

SBE

- Exterior en acero plastificado negro
- Interior en acero plastificado gris

SBIE

- Exterior en acero inoxidable
- Interior en acero plastificado gris

CARACTERISTICAS COMUNES

- Diseñados para bebidas y productos envasados
- Encastrables
- Doble cristal sobre marco abatible
- Estantes de alambre de acero plastificado, regulables en altura
- Compresor hermético alto par de arranque
- Evaporador sistema tiro forzado, con recubrimiento epoxi anticorrosión
- Control digital de temperatura, descarches optimizados, alarma por alta temperatura de condensación. Eficiente gestión del consumo de energía
- Iluminación interior LEDs
- Aislamiento de poliuretano inyectado, densidad 40 Kg/m³, bajo GWP y cero efecto ODP
- Pies regulables, con suplemento para altura 880 mm (incluido)
- Evaporación automática del agua de descarche
- Temperatura de trabajo a 32°C ambiente
- Tensión monofásica 230V - 50Hz

SBE

- Anthracite plastic coated steel exterior
- Interior gray plastic coated steel

SBIE

- Stainless steel exterior
- Interior gray plastic coated steel

FEATURES IN COMMON

- Designed for beverages and packaged products
- "Built-in" designed
- Double glass on folding frame
- Steel wire shelves adjustable plastic height
- Hermetic compressor higher starting torque
- Forced draft evaporator system with anticorrosion coating
- Digital temperature control, optimized defrost, high-temperature condensation alarm. Efficient management of energy consumption
- LEDs interior lighting
- Isolation of polyurethane, density 40 Kg / m³, zero ODP and GWP
- Adjustable feet, with suplement for height 880 mm (included)
- Automatic evaporation of defrost water
- Operating temperature 32°C ambient
- Voltage 230V - 50Hz

BAR EQUIPMENT • EQUIPAMIENTO PARA BARES

OPCIONES	OPTIONS	€
set 6 ruedas	6 castors set	120 € x set
set 4 ruedas	4 castors set	80 € x set
230v 60Hz / 115v 60Hz	230v 60Hz / 115v 60Hz	consultar- consult
motor lado izquierdo	left side engine	60 €
cambio a estante chapa inox	SS panel shelve increase	65 € x ud
cambio R290 por R134a	R290 to R134a	0 €

SBE-200
motor izquierda
left side engine

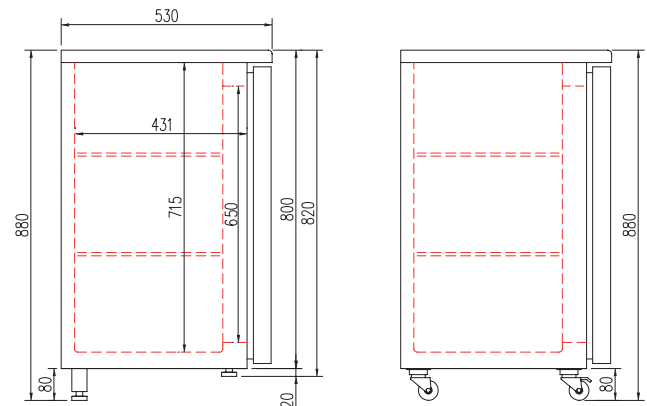

all photos must be considered as a reference - fotografías no contractuales



min 820 mm
max 880 mm



SBIE-250



SBE-150
estantes chapa inox opcional
optional SS panel shelves



SBEP-120 1.547 €



SBEP-170 1.905 €



SBEP-220 2.294 €



SBIEP-120 1.610 €



SBIEP-170 1.984 €



SBIEP-220 2.383 €

mod.	rango range °C	largo length (mm)	alto height (mm)	fondo depth (mm)	estantes shelves	capacidad latas cans capacity (33 cl.)	capacidad capacity (L)	voltaje voltage	refrigerante recomendado recommended refrigerant	potencia frig. frig. power W
SBEP/SBIEP-120	+2°C +8°C	1165	820-880	530	4	320	325	230V-50Hz	R-134a	480
SBEP/SBIEP-170	+2°C +8°C	1705	820-880	530	6	500	490	230V-50Hz	R134a	500
SBEP/SBIEP-220	+2°C +8°C	2245	820-880	530	8	680	650	230V-50Hz	R134a	520

Características técnicas y constructivas sujetas a variación sin previo aviso.

We reserve the right to change specifications without prior notice.

SBEP

- Exterior en acero plastificado negro
- Interior en acero plastificado gris

SBIEP

- Exterior en acero inoxidable
- Interior en acero plastificado gris

CARACTERISTICAS COMUNES

- Diseñados para bebidas y productos envasados
- Doble cristal sobre marco abatible
- Estantes de alambre de acero plastificado, regulables en altura
- Evaporador sistema tiro forzado, con recubrimiento epoxi anticorrosión
- Control digital de temperatura, descarches optimizados, alarma por alta temperatura de condensación. Eficiente gestión del consumo de energía
- Iluminación interior LEDs
- Aislamiento de poliuretano inyectado, densidad 40 Kg/m³, bajo GWP y cero efecto ODP
- Pies regulables, con suplemento para altura 880 mm (incluido)
- Temperatura de trabajo a 32°C ambiente
- Tensión monofásica 230V - 50Hz
- Unidad condensadora **NO INCLUIDA**, refrigerante recomendado R134a
- Control de expansión de refrigerante **NO INCLUIDO**
- Rendimiento del evaporador con $\Delta t=12^{\circ}\text{C}$
- Evaporación automática **opcional**
- Válvula de expansión, **opcional**

SBEP

- Anthracite plastic coated steel exterior
- Interior gray plastic coated steel

SBIEP

- Stainless steel exterior
- Interior gray plastic coated steel

FEATURES IN COMMON

- Designed for beverages and packaged products
- Double glass on folding frame
- Steel wire shelves adjustable plastic height
- Forced draft evaporator system with anticorrosion coating
- Digital temperature control, optimized defrost, high-temperature condensation alarm. Efficient management of energy consumption
- LEDs interior lighting
- Isolation of polyurethane, density 40 Kg / m³, zero ODP and GWP
- Adjustable feet, with suplement for height 880 mm (included)
- Operating temperature 32°C ambient
- Voltage 230V - 50Hz
- Condenser unit **NOT INCLUDED**, recommended refrigerant R134a
- Refrigerant expansion control, **NOT INCLUDED**
- Performance of the evaporator with $\Delta t = 12^{\circ}\text{C}$
- Optional automatic evaporation of defrost water
- Expansion valve, on demand

OPCIONES	OPTIONS	€
evaporación automática	automatic evaporation	225 € x set
válvula de expansión	expansion valve	155 € x set
230v 60Hz / 115v 60Hz	230v 60Hz / 115v 60Hz	consultar - consult
cambio a estante chapa inox	SS panel shelve increase	65 € x ud

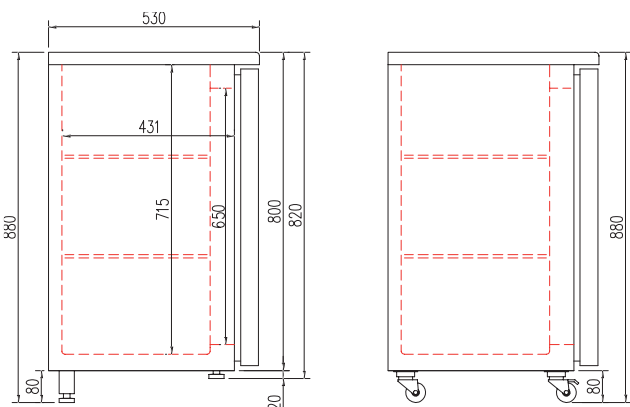

Expositor refrigerado SNACK-BAR pre-instalación
Remote condenser unit SNACK-BAR display cooler

3

all photos must be considered as a reference - fotografías no contractuales



min 820 mm
max 880 mm



SBIEP-120



SBEP-250

BAR 3

SB-150 1.579 €

SB-200 1.894 €

SB-250 2.216 €

SBI-150 1.632 €

SBI-200 1.957 €

SBI-250 2.294 €

mod.	rango range °C	largo length (mm)	alto height (mm)	fondo depth (mm)	estantes shelves	capacidad latas cans capacity (33 cl.)	capacidad capacity (L)	voltaje voltage	refrigerante refrigerant	potencia frig. frig. power W	potencia power W
SB/SBI-150	+2°C +8°C	1465	820-880	530	4	320	325	230V-50Hz	R134a*	380	476
									R290	845	400
SB/SBI-200	+2°C +8°C	2005	820-880	530	6	500	490	230V-50Hz	R134a*	485	584
									R290	845	407
SB/SBI-250	+2°C +8°C	2545	820-880	530	8	680	650	230V-50Hz	R134a*	515	589
									R290	845	413

*opcional - optional

Características técnicas y constructivas sujetas a variación sin previo aviso.

We reserve the right to change specifications without prior notice.

SB

- Exterior en acero plastificado negro
- Interior en acero plastificado gris

SBI

- Exterior en acero inoxidable
- Interior en acero plastificado gris

CARACTERISTICAS COMUNES

- Diseñados para bebidas y productos envasados
- Encastrables
- Estantes de alambre de acero plastificado, regulables en altura
- Compresor hermético alto par de arranque
- Evaporador sistema tiro forzado, con recubrimiento epoxi anticorrosión
- Control digital de temperatura, descarches optimizados, alarma por alta temperatura de condensación. Eficiente gestión del consumo de energía
- Aislamiento de poliuretano inyectado, densidad 40 Kg/m³, bajo GWP y cero efecto ODP
- Pies regulables, con suplemento para altura 880 mm (incluido)
- Evaporación automática del agua de descarche
- Temperatura de trabajo a 32°C ambiente
- Tensión monofásica 230V - 50Hz

SB

- Anthracite plastic coated steel exterior
- Interior gray plastic coated steel

SBI

- Stainless steel exterior
- Interior gray plastic coated steel

FEATURES IN COMMON

- Designed for beverages and packaged products
- "Built-in" designed
- Steel wire shelves adjustable plastic height
- Hermetic compressor higher starting torque
- Forced draft evaporator system with anticorrosion coating
- Digital temperature control, optimized defrost, high-temperature condensation alarm. Efficient management of energy consumption
- Isolation of polyurethane, density 40 Kg / m³, zero ODP and GWP
- Adjustable feet, with suplement for height 880 mm (included)
- Automatic evaporation of defrost water
- Operating temperature 32°C ambient
- Voltage 230V - 50Hz

OPCIONES	OPTIONS	€
Cajonera doble INOX	Stainless Steel double drawers set	400 €
Cajonera doble plast. negro	Black plastic coated double drawers set	370 €
Cajonera triple INOX	Stainless Steel triple drawers set	580 €
Cajonera triple plast. negro	Black plastic coated triple drawers set	550 €
separador interior cajón	drawer internal divider	14 € x ud
set 6 ruedas	6 castors set	120 € x set
set 4 ruedas	4 castors set	80 € x set
230v 60Hz / 115v 60Hz	230v 60Hz / 115v 60Hz	consultar- consult
motor lado izquierdo	left side engine	60 €
cambio a estante chapa inox	SS panel shelve increase	65 € x ud
cambio R290 por R134a	R290 to R134a	0 €

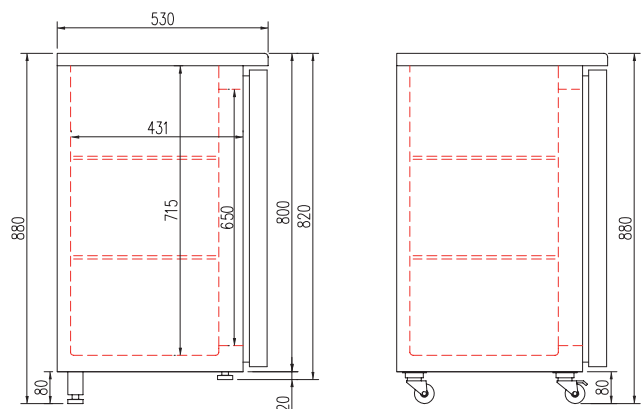

all photos must be considered as a reference - fotografías no contractuales



min 820 mm
max 880 mm



SB-250 con 2 sets cajones
with 2 drawers sets



SBI-200 con 3 sets cajones
with 3 drawers sets



SBP-120 1.342 €



SBP-170 1.600 €



SBP-220 1.873 €



SBIP-120 1.394 €



SBIP-170 1.662 €



SBIP-220 1.952 €

mod.	rango range °C	largo length (mm)	alto height (mm)	fondo depth (mm)	estantes shelves	capacidad latas cans capacity (33 cl.)	capacidad capacity (L)	voltaje voltage	refrigerante recomendado recommended refrigerant	potencia frig. frig. power W
SBP/SBIP-120	+2°C +8°C	1165	820-880	530	4	320	325	230V-50Hz	R-134a	480
SB-P/SBIP-170	+2°C +8°C	1705	820-880	530	6	500	490	230V-50Hz	R134a	500
SBP/SBIP-220	+2°C +8°C	2245	820-880	530	8	680	650	230V-50Hz	R134a	520

Características técnicas y constructivas sujetas a variación sin previo aviso.

We reserve the right to change specifications without prior notice.

SBP

- Exterior en acero plastificado negro
- Interior en acero plastificado gris

SBIP

- Exterior en acero inoxidable
- Interior en acero plastificado gris

SBP

- Anthracite plastic coated steel exterior
- Interior gray plastic coated steel

SBIP

- Stainless steel exterior
- Interior gray plastic coated steel

CARACTERÍSTICAS COMUNES

- Diseñados para bebidas y productos envasados
- Doble cristal sobre marco abatible
- Estantes de alambre de acero plastificado, regulables en altura
- Evaporador sistema tiro forzado, con recubrimiento epoxi anticorrosión
- Control digital de temperatura, descarches optimizados, alarma por alta temperatura de condensación. Eficiente gestión del consumo de energía
- Aislamiento de poliuretano inyectado, densidad 40 Kg/m³, bajo GWP y cero efecto ODP
- Pies regulables, con suplemento para altura 880 mm (incluido)
- Temperatura de trabajo a 32°C ambiente
- Tensión monofásica 230V - 50Hz
- Unidad condensadora **NO INCLUIDA**, refrigerante recomendado R134a
- Control de expansión de refrigerante **NO INCLUIDO**
- Rendimiento del evaporador con Δt=12°C
- Evaporación automática **opcional**
- Válvula de expansión, **opcional**

FEATURES IN COMMON

- Designed for beverages and packaged products
- Double glass on folding frame
- Steel wire shelves adjustable plastic height
- Forced draft evaporator system with anticorrosion coating
- Digital temperature control, optimized defrost, high-temperature condensation alarm. Efficient management of energy consumption
- Isolation of polyurethane, density 40 Kg / m³, zero ODP and GWP
- Adjustable feet, with suplement for height 880 mm (included)
- Operating temperature 32°C ambient
- Voltage 230V - 50Hz
- Condenser unit **NOT INCLUDED**, recommended refrigerant R134a
- Refrigerant expansion control, **NOT INCLUDED**
- Performance of the evaporator with Δt = 12°C
- Optional automatic evaporation of defrost water
- Expansion valve, on demand

OPCIONES	OPTIONS	€
Cajonera doble INOX	Stainless Steel double drawers set	400 €
Cajonera doble plast. negro	Black plastic coated double drawers set	370 €
Cajonera triple INOX	Stainless Steel triple drawers set	580 €
Cajonera triple plast. negro	Black plastic coated triple drawers set	550 €
separador interior cajón	drawer internal divider	14 € x ud
evaporación automática	automatic evaporation	225 € x set
válvula de expansión	expansion valve	155 € x set
230v 60Hz / 115v 60Hz	230v 60Hz / 115v 60Hz	consultar- consult
cambio a estante chapa inox	SS panel shelve increase	65 € x ud

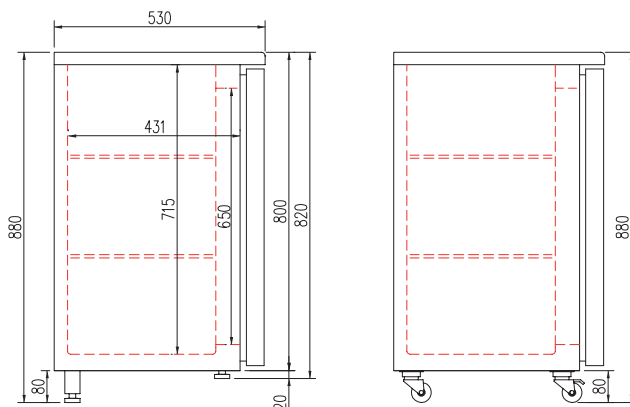

all photos must be considered as a reference - fotografías no contractuales





- Exterior en acero plastificado negro o acero inoxidable AISI-304
- Cuerpo interior en acero inoxidable AISI-304
- Guías telescópicas AISI-304, desmontables con pestillo de seguridad
- Capacidad de carga dinámica 65 Kg.
- Tirador ergonómico, de fácil limpieza
- Separadores interiores adaptables a diferentes medidas (opcional)
- Set de cajones, intercambiables con puertas

- Anthracite plastic coated or AISI-304 Stainless steel
- Internal structure in AISI-304 Stainless steel
- AISI-304, detachable runners with security click
- Dynamic load capacity 65 Kg.
- Ergonomic handle, easy to clean
- Adaptable internal dividers (optional)
- Doors and drawers sets are interchangeable

BAR EQUIPMENT • EQUIPAMIENTO PARA BARES

∅ 53 mm



∅ 60 mm



∅ 66 mm

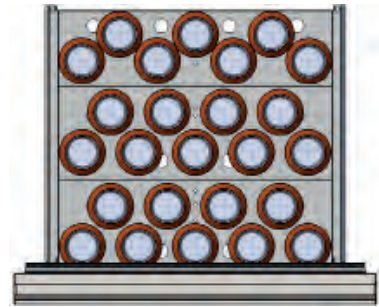

∅ 70 mm

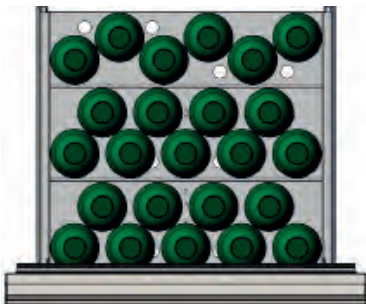

∅ 80 mm

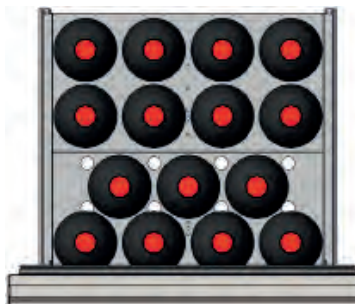

∅ 105 mm

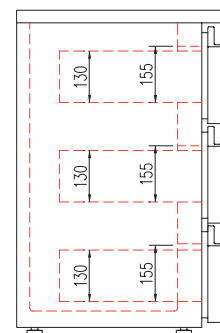
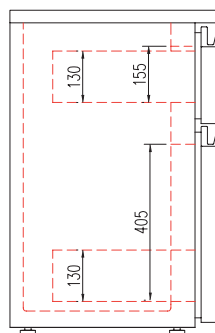
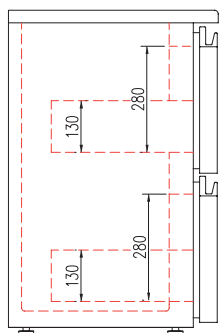
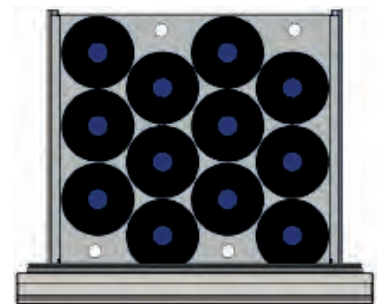

all photos must be considered as a reference - fotografías no contractuales





EE-85 1.200 €



EC-85 1.078 €

mod.	rango range °C	largo length (mm)	alto height (mm)	fondo depth (mm)	estantes shelves	capacidad capacity (L)	voltaje voltage	refrigerante refrigerant	potencia frig. frig. power W	potencia power W
EE-85	-5°C -10°C	510	850	505	1	60	230V-50Hz	R134a*	107	168
								R290	158	150
EC-85	-5°C -10°C	510	850	505	1	0	230V-50Hz	R134a*	107	168
								R290	158	150

*opcional - optional

BAR EQUIPMENT • EQUIPAMIENTO PARA BARES

Características técnicas y constructivas sujetas a variación sin previo aviso.

- Exterior en acero inox AISI-304, excepto el respaldo
- Interior en acero inox AISI-304, con aristas curvas y fondo embutido
- Puertas de apertura reversible, con sistema de cierre automático y burlete magnético (permanece abierta al superar los 90° de apertura)
- EE doble cristal
- Encimera de acero inox AISI-304
- Estantes interiores de alambre en acero plastificado, regulables en altura
- Apoyos regulables en altura
- Unidad condensadora ventilada
- Evaporador placa fría
- Aislamiento de poliuretano inyectado, densidad 40 Kg/m³, cero efectos ODP y GWP
- Control digital de temperatura, descarches optimizados, alarma por alta temperatura de condensación. Eficiente gestión del consumo de energía
- Temperatura de trabajo a 32°C ambiente

We reserve the right to change specifications without prior notice.

- AISI-304 stainless steel exterior, rear side galvanized panel
- AISI-304 stainless steel interior, stamped bottom and rounded corners
- Doors with self closing system, blocked opening, magnetic gasket and possibility of changing the opening sense
- EE double glazed door
- AISI-304 stainless steel worktop
- Shelves made of plasticized steel wire, height adjustable
- Adjustable supports
- Fan assisted condenser unit
- Cold plate evaporator
- 40 Kg/m³ density polyurethane insulation, zero ODP and GWP
- Digital temperature control, optimized defrost, high-temperature condensation alarm. Efficient management of energy consumption
- Operating temperature 32°C ambient

OPCIONES	OPTIONS	€
set 4 ruedas	4 castors set	80 € x set
cambio R290 por R134a	R290 to R134a	0 €
230v 60Hz / 115v 60Hz	230v 60Hz / 115v 60Hz	consultar - consult

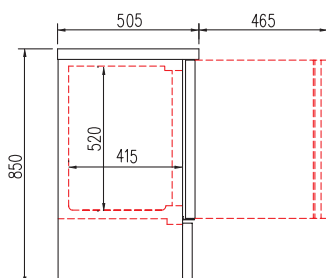

all photos must be considered as a reference - fotografías no contractuales



EC-140 1.378 €



NR-140 1.126 €



DP-140 1.220 €



ECE-140 1.562 €



NRE-140 1.205 €



DPE-140 1.310 €

mod.	rango range °C	largo length (mm)	alto height (mm)	fondo depth (mm)	pares de guías slides sets	estantes shelves	cajas containers	capacidad capacity (L)	voltaje voltage	refrigerante refrigerant	potencia frig. frig. power W	potencia power W
EC-140	-5°C -15°C	645	805	640	2	2	0	125	230V-50Hz	R290	361	285
										R452A*	353	468
DP-140	-5°C -1°C	645	805	640	3	0	3	125	230V-50Hz	R134a*	178	229
										R290	190	185
NR-140	-2°C +8°C	645	805	640	2	2	0	125	230V-50Hz	R134a*	178	208
										R290	190	164

*opcional - optional

Características técnicas y constructivas sujetas a variación sin previo aviso.

We reserve the right to change specifications without prior notice.

- Exterior en acero inox AISI-304, excepto el respaldo
- Interior en acero inox AISI-304, con aristas curvas y fondo embutido, compatible GN 1/1.
- Puertas de apertura reversible, con sistema de cierre automático y burlete magnético (permanece abierta al superar los 90° de apertura)
- Encimera de acero inox AISI-304
- Estantes interiores 530x440 de alambre en acero plastificado, regulables en altura
- DP contenedores plástico 530x460 sobre guías de acero inox
- Apoyos regulables en altura
- Unidad condensadora ventilada
- Evaporador sistema tiro forzado, con recubrimiento epoxi anticorrosión-Aislamiento de poliuretano inyectado, densidad 40 Kg/m³
- Control digital de temperatura, descarches optimizados, alarma por alta temperatura de condensación. Eficiente gestión del consumo de energía
- Temperatura de trabajo a 32°C ambiente

- AISI-304 stainless steel exterior, rear side galvanized panel
- AISI-304 stainless steel interior, stamped bottom and rounded corners, GN 1/1 capacity.
- Doors with self closing system, blocked opening, magnetic gasket and possibility of changing the opening sense
- AISI-304 stainless steel worktop
- 530x440 shelves made of plasticized steel wire, height adjustable
- DP, 3 plastic containers 530x460
- Adjustable supports
- Fan assisted condenser unit
- Fan assisted evaporator, with epoxi anticorrosion coating.
- Isolation of polyurethane, density 40 Kg / m³, zero ODP and GWP
- Digital temperature control, optimized defrost, high-temperature condensation alarm. Efficient management of energy consumption
- Operating temperature 32°C ambient

OPCIONES	OPTIONS	€
cerradura puerta inox	solid door lock	20 € x ud
cerradura puerta cristal	glass door lock	50 € x set
set 4 ruedas	4 castors set	80 € x set
230v 60Hz / 115v 60Hz	230v 60Hz / 115v 60Hz	consultar- consult
cambio R290 por R134a	R290 to R134a	0 €
cambio R290 por R452A	R290 to R452A	0 €



ECE - 140

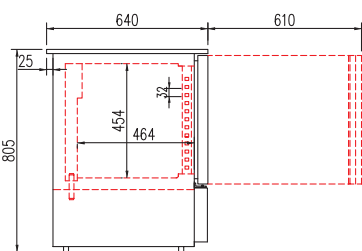

EC/ ECE / NR - 140

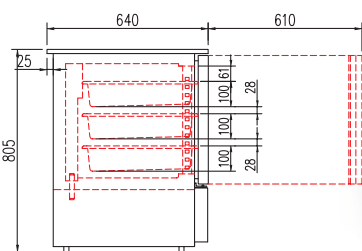

DP - 140





EC-3 525 €

EC-400 591 €

ECCM-450 617 €

EC-520 772 €

ECC-520 787 €

mod.	rango range °C	largo length (mm)	alto height (mm)	fondo depth (mm)	estantes shelves	capacidad capacity (L)	voltaje voltage	refrigerante refrigerant	potencia frig. frig. power W	potencia power W
EC-3	0°C +7°C	410	512	452	1	30	230V-50Hz	R600a	115	72
EC-400	0°C +7°C	450	740	500	2	52	230V-50Hz	R600a	144	84
ECCM-450	0°C +7°C	450	900	500	2	72	230V-50Hz	R600a	144	87
ECC-520	0°C +7°C	520	1100	570	2	115	230V-50Hz	R600a	144	117
EC-520	0°C +7°C	520	945	560	2	115	230V-50Hz	R600a	144	114

Características técnicas y constructivas sujetas a variación sin previo aviso.

We reserve the right to change specifications without prior notice.

EC-3 / EC-400 / ECCM-450

- Exterior e interior en acero plastificado blanco

ECC / EC-520

- Exterior en acero plastificado blanco

- Interior en poliestireno sanitario termo-conformado

EC-3 / EC-400 / ECCM-450

- Exterior and interior in white plastic coated steel

ECC / EC-520

- White plastic coated steel exterior

- Interior in sanitary polystyrene thermoforming

CARACTERISTICAS COMUNES

- Diseñados para bebidas y productos envasados
- Puerta con doble cristal sobre marco de aluminio
- Estantes de alambre de acero plastificado, regulables en altura
- Compresor hermético alto par de arranque
- Evaporador ventilado impreso en placa de aluminio
- Control digital de temperatura y descarches
- Iluminación interior LEDs
- Unidad condensadora ventilada
- Aislamiento de poliuretano inyectado, densidad 40 Kg/m³, cero efectos ODP y GWP
- Evaporación automática del agua de descarche
- Temperatura de trabajo 32°C ambiente
- Tensión monofásica 230V - 50 Hz

FEATURES IN COMMON

- Designed for beverages and packaged
- Double glass doors with aluminium frame
- Shelves plastic coated steel wire, adjustable height
- Hermetic compressor higher starting torque
- Ventilated evaporator printed on aluminum plate
- Digital temperature control and defrost
- Interior LEDs lighting
- Ventilated condensing unit
- 40 Kg/m³ density polyurethane insulation, zero ODP and GWP
- Automatic evaporation of defrost water
- Operating temperature 32°C ambient
- Voltage 230V - 50 Hz

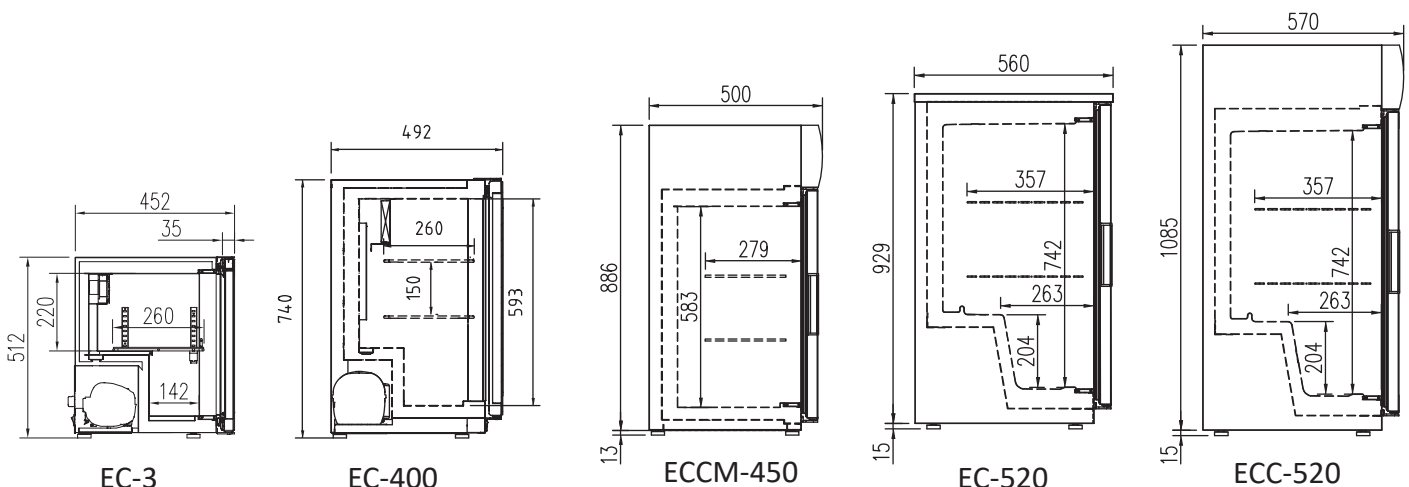



EC-620 1.009 €



ECC-620 1.024 €

mod.	rango range °C	largo length (mm)	alto height (mm)	fondo depth (mm)	estantes shelves	capacidad capacity (L)	voltaje voltage	refrigerante refrigerant	potencia frig. frig. power W	potencia power W
ECC-620	0°C +7°C	620	2000	640	4	388	230V-50Hz	R600a	176	156
EC-620	0°C +7°C	620	1880	640	4	388	230V-50Hz	R600a	176	151

Características técnicas y constructivas sujetas a variación sin previo aviso.

- Exterior en acero plastificado blanco
- Interior en poliestireno sanitario termo-conformado
- Diseñados para bebidas y productos envasados
- Puerta con doble cristal sobre marco de aluminio (excepto EC-400)
- Estantes de alambre de acero plastificado, regulables en altura
- Compresor hermético alto par de arranque
- Evaporador ventilado impreso en placa de aluminio
- Control digital de temperatura y descarches
- Iluminación interior LEDs
- Aislamiento de poliuretano inyectado, densidad 40 Kg/m³, cero efectos ODP y GWP
- Evaporación automática del agua de descarche
- Temperatura de trabajo 32°C ambiente
- Tensión monofásica 230V - 50 Hz

We reserve the right to change specifications without prior notice.

- White plastic coated steel exterior
- Interior in sanitary polystyrene thermoforming
- Designed for beverages and packaged
- Double glass doors with aluminium frame (except EC-400)
- Shelves plastic coated steel wire, adjustable height
- Hermetic compressor higher starting torque
- Ventilated evaporator printed on aluminum plate
- Digital temperature control and defrost
- Interior LEDs lighting
- 40 Kg/m³ density polyurethane insulation, zero ODP and GWP
- Automatic evaporation of defrost water
- Operating temperature 32°C ambient
- Voltage 230V - 50 Hz

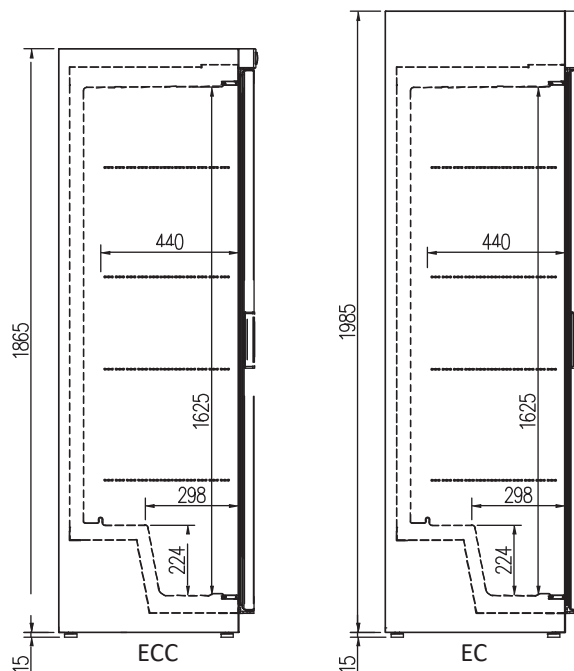



CMb-5-50 1.493 €



CM-62 1.874 €

mod.	largo length (mm)	alto height (mm)	fondo depth (mm)	estantes shelves	capacidad capacity (L)	voltaje voltage	refrigerante refrigerant	potencia frig. frig. power W	potencia power W
CM-62	620	1870	640	4	375	230V-50Hz	R290	851	1430
CMb-5-50	530	1430	635	3	197	230V-50Hz	R290	851	1419

Características técnicas y constructivas sujetas a variación sin previo aviso.

We reserve the right to change specifications without prior notice.

- **CM-62**
- Exterior e interior en acero plastificado blanco
- **CMb-5-50**
- Exterior en acero plastificado blanco, costados exteriores en madera MDF, interior acero plastificado blanco
- Diseñados para bebidas y productos envasados
- Estantes de acero plastificado regulables en altura y ángulo, con portaprecios
- De serie: Luz horizontal, vertical y cortina nocturna
- Control digital de temperatura y descarches
- De serie: Luz vertical led y cortina nocturna
- Evaporación y condensación ventilada
- Aislamiento de poliuretano inyectado, libre CFCs, densidad 40 Kg/m³
- Evaporación automática del agua de descarche
- Clase climática 3 (25°C 60%HR) régimen M1, temperatura producto -1/5°C UNE EN ISO 23953-2:2006
- Tensión monofásica 230V 50Hz
- **CM-62**
- Exterior and interior in white plastic coated steel
- **CMb-5-50**
- Exterior in white plastic coated steel, sides in MDF wood, white plastic coated steel interior
- Designed for beverages and packaged
- Plastic coated steel shelves adjustable in height and angle, with portaprecios
- Standard: horizontal, vertical and night light curtain
- Digital temperature control and defrost
- Standard: Led vertical lighting and night blind
- Ventilated evaporation and condensation
- Insulation: Polyurethane, CFC, density 40 Kg / m³
- Automatic evaporation of defrost water
- Climatic class 3 (25°C 60%HR) regime M1, product temperature -1/5°C UNE EN ISO 23953-2:2006
- Voltage 230V 50Hz

OPCIONES	OPTIONS	€
set 4 ruedas	4 castors set	80 € x set
230v 60Hz / 115v 60Hz	230v 60Hz / 115v 60Hz	consultar- consult
otro color exterior	other external color	consultar- consult

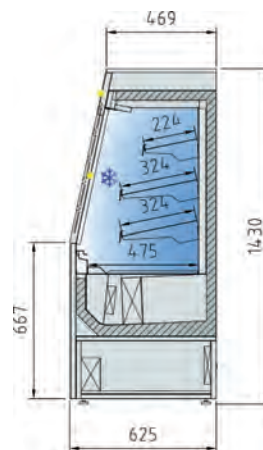

CMb-5-50

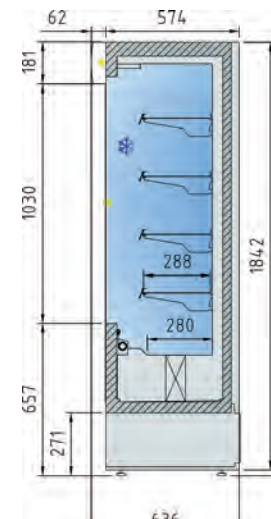

CM-62



AGPC-125 2.245 €

mod.	rango range °C	largo length (mm)	alto height (mm)	fondo depth (mm)	estantes shelves	capacidad capacity (L)	voltaje voltage	refrigerante refrigerant	potencia frig. frig. power W	potencia power W
AGPC-125	0°C +7°C	1250	2025	635	8	750	230V-50Hz	R290	845	372

all photos must be considered as a reference - fotografías no contractuales

Características técnicas y constructivas sujetas a variación sin previo aviso.

- Exterior e interior en acero plastificado blanco
- Estantes de alambre de acero plastificado
- Aislamiento de poliuretano inyectado, densidad 40 Kg/m³, bajo GWP y cero efecto ODP
- Control digital de temperatura, descarches optimizados, alarma por alta temperatura de condensación. Eficiente gestión del consumo de energía
- Doble cristal sobre marco abatible, bisagras autocierre
- Luz interior LEDs
- Diseñados para bebidas y productos envasados
- Evaporación automática del agua de descarche
- Unidad condensadora ventilada
- Evaporador ventilado impreso en placa de aluminio
- Temperatura de trabajo a 32°C ambiente

We reserve the right to change specifications without prior notice.

- Exterior and interior in white plastic coated steel
- Shelves made of plasticized steel wire
- 40 Kg/m³ density polyurethane insulation, zero ODP and GWP controller of temperature and defrosts
- Energy efficient digital temperature control, optimized defrost, high-temperature condensation alarm. Efficient management of energy consumption
- AGPC: Double glazed front opening doors, self-closing hinges
- LEDs interior lighting
- Designed for drinks and packaged products
- Automatic evaporation of defrost water
- Fan assisted condenser unit
- Fan assisted cold plate evaporator
- Operating temperature 32°C ambient

OPCIONES	OPTIONS	€
set 4 ruedas	4 castors set	80 € x set
230v 60Hz / 115v 60Hz	230v 60Hz / 115v 60Hz	consultar - consult
otro color exterior	other external color	consultar - consult
cambio a estante chapa inox	SS panel shelf increase	65 € x ud
cambio R290 por R134a	R290 to R134a	0 €

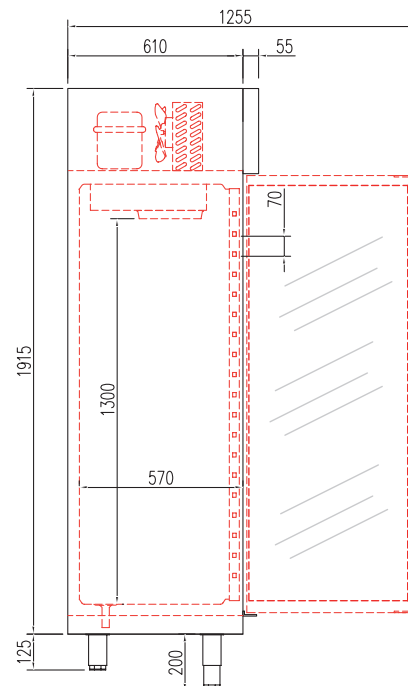



EBR-751-NI	1.910 €
EBR-751-BI	
EBC-751-NI	2.720 €
EBC-751-BI	

EBR-1302-NI	2.737 €
EBR-1302-BI	
EBC-1302-NI	3.905 €
EBC-1302-BI	

EBR-2003-NI	3.563 €
EBR-2003-BI	
EBC-2003-NI	5.090 €
EBC-2003-BI	

mod.	rango range °C	largo length (mm)	alto height (mm)	fondo depth (mm)	estantes shelves	volumen capacity (L)	voltaje voltage	refrigerante refrigerant	potencia frig. frig. power W	potencia power W
EBR-751	-2°C +8°C	680	2040	730	4	505	230V-50Hz	R134a* R290	245 502	264 260
EBC-751	-20°C -15°C	680	2040	730	4	505	230V-50Hz	R290 R452A*	606 452	560 627
EBR-1302	-2°C +8°C	1370	2040	730	8	1201	230V-50Hz	R134a* R290	485 845	461 396
EBC-1302	-20°C -15°C	1370	2040	730	8	1201	230V-50Hz	R290 R452A*	907 1042	902 1010
EBR-2003	-2°C +8°C	2055	2040	730	12	1852	230V-50Hz	R452A* R290	1215 1702	932 943
EBC-2003	-20°C -15°C	2055	2040	730	12	1852	230V-50Hz	R290 R452A*	1814 1235	1726 1556

*opcional - optional

Características técnicas y constructivas sujetas a variación sin previo aviso.

We reserve the right to change specifications without prior notice.

- Exterior en acero plastificado blanco (BI) o negro (NI) al mismo precio
- Interior en acero inoxidable AISI-304, con aristas curvas y fondo inox embutido
- Puertas de apertura reversible, con sistema de cierre automático y burlete magnético (permanece abierta al superar los 90° de apertura)
- EBR: Doble cristal, EBC: Triple cristal
- Iluminación interior reforzada con doble tira de LEDs
- Estantes interiores REFORZADOS en acero plastificado, regulables en altura
- Reguladores de altura, ruedas o patas opcionales
- Cuadro de mandos y rejilla ventilación motor, desmontables
- Unidad condensadora ventilada
- Evaporador sistema tiro forzado, con recubrimiento epoxi anticorrosión
- Paro ventiladores tiro forzado al abrir la puerta
- Evaporación automática del agua de descarche
- Aislamiento de poliuretano inyectado, densidad 40 Kg/m³, cero efectos ODP y GWP
- Control digital de temperatura, descarches optimizados, alarma por puerta abierta y alta temperatura de condensación. Eficiente gestión del consumo de energía
- Temperatura de trabajo a 32° ambiente

- White (BI) or black (NI) plastic coated exterior, same price
- AISI-304 stainless steel interior, stamped bottom and rounded corners
- Doors with self closing system, blocked opening, magnetic gasket and possibility of changing the opening sense
- EBR: Double glazed door, EBC: Triple glazed doors
- Double LEDs internal lighting
- REINFORCED shelves made of plasticized steel wire, height adjustable
- Height Adjustable knobs, castors or legs on demand
- Control panel and compressor ventilation grill, removable
- Fan assisted condenser unit
- Fan assisted evaporator, with epoxi anticorrosion coating
- Evaporator fan stops when door is opened
- Automatic evaporation of defrost water
- 40 Kg/m³ density polyurethane insulation, zero ODP and GWP
- Digital temperature control, optimized defrost, door open and high-temperature condensation alarms. Efficient management of energy consumption
- Operating temperature 32° ambient

BAR EQUIPMENT • EQUIPAMIENTO PARA BARES



Exterior blanco o negro al mismo precio

Black or white exterior same price



EBR-751-NI

	STANDARD
BI	ext. blanco + int. inox white ext + SS interior
NI	ext. negro + int. inox black ext. + SS interior
	ON DEMMAND
BB	ext. blanco + int. blanco white ext + white interior
NN	ext. negro + int. negro black ext. + black interior

otras combinaciones, consultar ask for other combinations

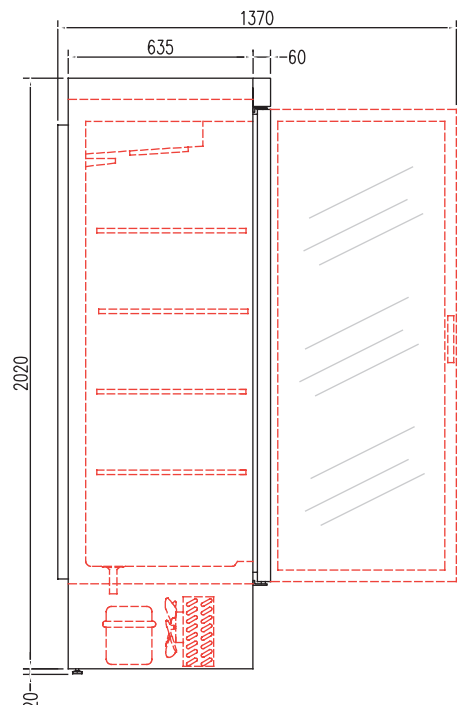

OPCIONES	OPTIONS	€
parrilla adicional	extra shelf	29 € x ud
porta-recios	label-holder srtip	6 € x ud
cerradura puerta cristal	glass door lock	50 € x ud
otro color exterior o interior	other external or internal color	consultar- consult
set 4 ruedas	4 castors set	80 € x set
set 6 ruedas	6 castorsset	120 € x set
set 4 patas	4 castors set	45 € x set
set 6 patas	6 castorsset	70 € x set
cambio R290 por R134a	R290 to R134a	0 €
cambio R290 por R452A	R290 to R452A	0 €
230v 60Hz / 115v 60Hz	230v 60Hz / 115v 60Hz	consultar- consult

all photos must be considered as a reference - fotografías no contractuales

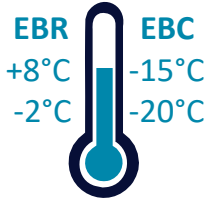

EBR-1302-BI
Patas opcionales
Optional legs



EBR-2003-NN
Interior negro, opcional
Optional black interior



RVC-1002-NB	2.890 €
RVC-1002-BB	
CVC-1002-NB	4.190 €
CVC-1002-BB	



RVC-2003-NB	3.684 €
RVC-2003-BB	
CVC-2003-NB	5.280 €
CVC-2003-BB	

mod.	rango range	largo length (mm)	alto height (mm)	fondo depth (mm)	potencia frig. frig. power (W)	consumo consumption (W)	capacidad capacity (L)	estantes shelves	tensión monofásica single phase voltage	refrigerante refrigerant
RVC-1002	-2°C+8°C	1370	2040	810	845	410	1404	4+4	230V- 50 Hz	R-290
CVC-1002	-25°C-18°C	1370	2040	810	907	912	1404	4+4	230V- 50 Hz	R-290
RVC-2003	-2°C+8°C	2035	2040	810	2044	1500	1950	4+4	230V- 50 Hz	R-290
CVC-2003	-25°C-18°C	2035	2040	810	1814	1749	1950	4+4	230V- 50 Hz	R-290

características técnicas y constructivas sujetas a variación sin previo aviso

- Exterior en acero plastificado blanco (BB) o negro (NB) al mismo precio
- Interior en acero plastificado blanco (negro opcional), con aristas curvas y fondo inox embutido
- Puertas de apertura reversible, con sistema de cierre automático y burlete magnético (permanece abierta al superar los 90° de apertura)
- RVC: Doble cristal , CVC: Triple cristal
- Iluminación interior reforzada con doble tira de LEDs
- Estantes interiores de acero lacado blanco, regulables en altura con soportes tipo estantería y banda porta-precios
- Reguladores de altura, ruedas o patas opcionales
- Cuadro de mandos y rejilla ventilación motor, desmontables
- Unidad condensadora ventilada
- Evaporador sistema **cortina de aire**, con recubrimiento epoxi anticorrosión
- Cortina de aire a toda la altura del respaldo interior
- Paro ventiladores tiro forzado al abrir la puerta
- Evaporación automática del agua de descarche
- Aislamiento de poliuretano inyectado, densidad 40 Kg/m³, cero efectos ODP y GWP
- Control digital de temperatura, descarches optimizados, alarma por puerta abierta y alta temperatura de condensación. Eficiente gestión del consumo de energía
- Temperatura de trabajo a 32°C ambiente

we reserve the right to change specifications whitout prior notice

- White (BB) or black (NB) plastic coated exterior, same price
- White plastic coated interior (black on demand)
- stainless steel stamped bottom and rounded corners - Doors with self closing system, blocked opening, magnetic gasket and possibility of changing the opening sense
- RVC: Double glazed door + LEDs, CVC: Triple glazed door + LEDs
- Double LEDs internal lighting
- Heavy duty shelves made of coated panel, height adjustable by supports and label holder
- Height djustable knobs, castors or legs on demand
- Control panel and compressor ventilation grill, removable
- Fan assisted condenser unit
- Fan assisted evaporator, with epoxi anticorrosio coating
- Air curtain in the whole rear side
- Evaporator fan stops when door is opened
- Automatic evaporation of defrost water
- 40 Kg/m³ density polyurethane insulation, zero ODP and GWP
- Digital temperature control, optimized defros, door open and high-temperature condensation alarms. Efficient management of energy consumption
- Operating temperature 32°C ambient

BAR EQUIPMENT • EQUIPAMIENTO PARA BARES



RVC-1002-BB



Exterior negro o blanco al mismo precio

Black or white exterior same price



RVC-1002-NB

BB	ext. blanco + int. blanco	white ext + white int.	otras combinaciones, consultar ask for other combinations
BN	ext. blanco + int. negro	white ext. + black int.	
NB	ext. negro + int. blanco	black ext. + white int.	
NN	ext. negro + int. negro	black ext. + black int.	

OPCIONES	OPTIONS	€
cerradura puerta cristal	glass door lock	50 € x ud
otro color exterior o interior	other external or internal color	consultar- consult
set 4 ruedas	4 castors set	80 € x set
set 6 ruedas	6 castorsset	120 € x set
set 4 patas	4 castors set	45 € x set
set 6 patas	6 castorsset	70 € x set
cambio R134a por R290	R134a to R290	0 €
cambio R290 por R452A	R290 to R452A	0 €
230v 60Hz / 115v 60Hz	230v 60Hz / 115v 60Hz	consultar- consult

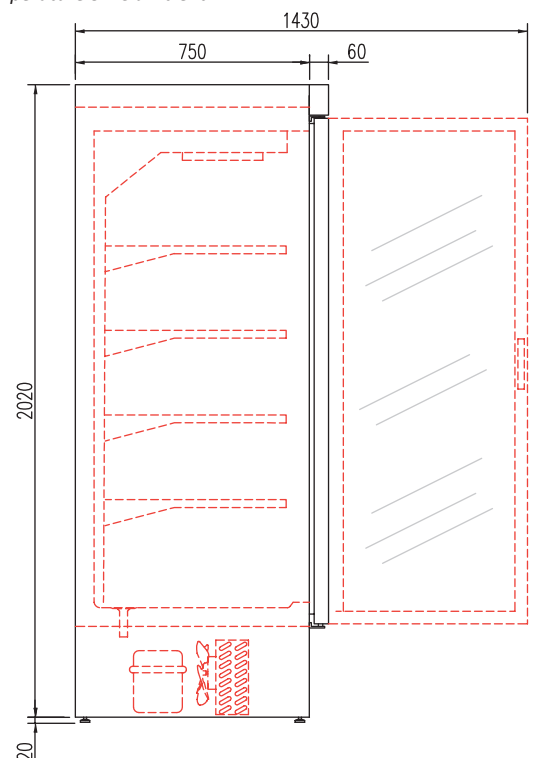

Armario SUPERMARKET, refrigeración y congelados por cortina de aire
Chiller and freezer air curtain SUPERMARKET cabinet

3

all photos must be considered as a reference - fotografías no contractuales

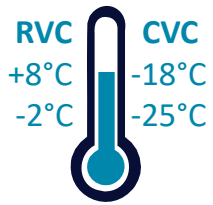

RVC-2003-BB



RVC-2003-NN





B-100	2.841 €	B-150	3.399 €	B-200	3.905 €	EB-100	3.099 €	EB-150	3.760 €	EB-200	4.372 €
BV-100	3.014 €	BV-150	3.673 €	BV-200	4.268 €	EBV-100	3.283 €	EBV-150	4.052 €	EBV-200	4.746 €

mod.	rango range °C	largo length (mm)	alto height (mm)	fondo depth (mm)	capacidad barriles kegs capacity	puertas inox inox doors	puertas cristal glass doors	voltaje voltage	refrigerante refrigerant	potencia frig. frig. power W	potencia power W
B-100	+5°C +8°C	1100	975	600	2	2	0	230V-50Hz	R134a*	485	430
									R290	845	340
B-150	+5°C +8°C	1600	975	600	3	3	0	230V-50Hz	R134a*	485	430
									R290	845	340
B-200	+5°C +8°C	2120	975	600	4	4	0	230V-50Hz	R134a*	485	430
									R290	845	340
EB-100	+5°C +8°C	1100	975	600	2	0	2	230V-50Hz	R134a*	485	440
									R290	845	350
EB-150	+5°C +8°C	1600	975	600	3	0	3	230V-50Hz	R134a*	485	446
									R290	845	356
EB-200	+5°C +8°C	2120	975	600	4	0	4	230V-50Hz	R134a*	485	461
									R290	845	362

*opcional - optional

mod	puerta ciega blind door	puerta cristal + LEDs glass door + LEDs	respaldo ciego blind rear side	respaldo cristal + LEDs glass rear side + LEDs
B	X		X	
BV	X			X
EB		X	X	
EBV		X		X



EBV-150 Respaldo de cristal Double glazed rear side

Características técnicas y constructivas sujetas a variación sin previo aviso.

- Exterior en acero inox AISI-304, excepto el respaldo
- Interior en acero inox AISI-304, con aristas curvas y fondo embutido
- Refuerzo para apoyo y deslizado de los barriles de 50 o 30 litros
- Puertas de apertura reversible, con sistema de cierre automático y burlete magnético (permanece abierta al superar los 90° de apertura)
- Chasis en tubo de acero inox y patas regulables
- Evaporador sistema tiro forzado, con recubrimiento epoxi anticorrosión
- Aislamiento de poliuretano inyectado, densidad 40 Kg/m³, cero efectos ODP y GWP
- Control digital de temperatura, descarches optimizados, alarma por alta temperatura de condensación. Eficiente gestión del consumo de energía
- Temperatura de trabajo a 32°C ambiente

We reserve the right to change specifications without prior notice.

- AISI-304 stainless steel exterior, rear side galvanized panel
- AISI-304 stainless steel interior, stamped bottom and rounded corners
- Reinforced base to drop and slide the barrels (50 or 30 liters)
- Doors with self closing system, blocked opening, magnetic gasket and possibility of changing the opening sense
- Worktop in stainless steel AISI-304 with drip perimeter
- AISI -304 base and legs
- Fan assisted evaporator, with epoxi anticorrosion coating.
- 40 Kg/m³ density polyurethane insulation, zero ODP and GWP
- Digital temperature control, optimized defrost, high-temperature condensation alarm. Efficient management of energy consumption
- Operating temperature, 32°C ambient

OPCIONES	OPTIONS	€
cambio R290 por R134a	R290 to R134a	0 €
230v 60Hz / 115v 60Hz	230v 60Hz / 115v 60Hz	consultar

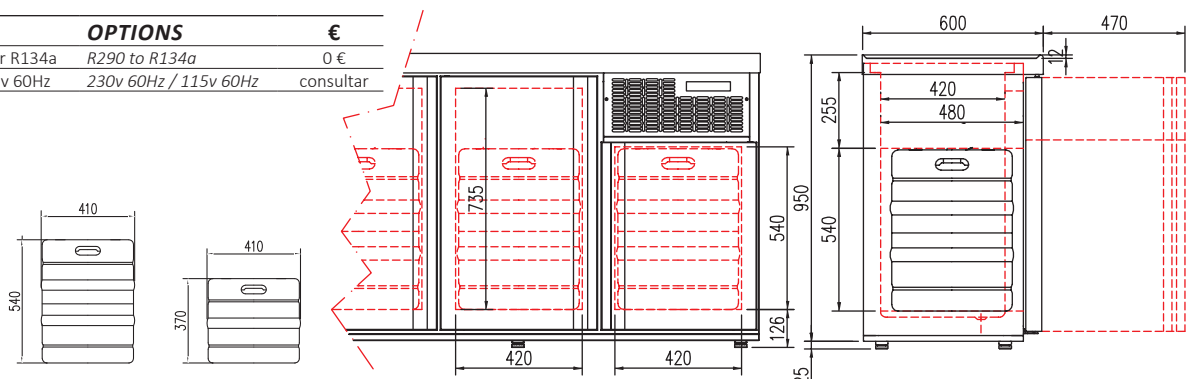

Enfriador de barriles PRE-INSTALACION REMOTE condenser unit kegs cooler

3

all photos must be considered as a reference - fotografías no contractuales



BP-120	2.153 €	BP-170	2.704 €	BP-220	3.183 €	EBP-120	2.396 €	EBP-170	3.045 €	EBP-220	3.630 €
BVP-120	2.332 €	BVP-170	2.978 €	BVP-220	3.546 €	EBVP-120	2.574 €	EBVP-170	3.337 €	EBVP-220	4.009 €

mod.	rango range °C	largo length (mm)	alto height (mm)	fondo depth (mm)	capacidad barriles kegs capacity	puertas inox inox doors	puertas cristal glass doors	voltaje voltage	refrigerante recomendado recommended refrigerant	potencia frig. frig. power W
BP-120	+5°C +8°C	1195	975	600	2	2	0	230V-50Hz	R134a	485
BP-220	+5°C +8°C	1720	975	600	3	3	0	230V-50Hz	R134a	485
EBP-170	+5°C +8°C	2245	975	600	4	4	0	230V-50Hz	R134a	485
EBP-100	+5°C +8°C	1195	975	600	2	0	2	230V-50Hz	R134a	485
EBP-150	+5°C +8°C	1720	975	600	3	0	3	230V-50Hz	R134a	485
EBP-200	+5°C +8°C	2245	975	600	4	0	4	230V-50Hz	R134a	485

mod	puerta ciega blind door	puerta cristal + LEDs glass door + LEDs	respaldo ciego blind rear side	respaldo cristal + LEDs glass rear side + LEDs
BP	X		X	
BVP	X			X
EBP		X	X	
EBVP		X		X



EBVP-170 Respaldo de cristal Double glazed rear side

Características técnicas y constructivas sujetas a variación sin previo aviso.

- Exterior en acero inox AISI-304, excepto el respaldo
- Interior en acero inox AISI-304, con aristas curvas y fondo embutido
- Refuerzo para apoyo y deslizado de los barriles de 50 o 30 litros
- Puertas de apertura reversible, con sistema de cierre automático y burlete magnético (permanece abierta al superar los 90° de apertura)
- Encimera de acero inox AISI-304 con perímetro vierte-aguas
- Chasis en tubo de acero inox y patas regulables
- Evaporador sistema tiro forzado, con recubrimiento epoxi anticorrosión
- Aislamiento de poliuretano inyectado, densidad 40 Kg/m³, cero efectos ODP y GWP
- Control digital de temperatura, descarches optimizados, alarma por alta temperatura de condensación (opcional). Eficiente gestión del consumo de energía
- Temperatura de trabajo a 32°C ambiente

230v 60Hz / 115v 60Hz consultar - consult

We reserve the right to change specifications without prior notice.

- AISI-304 stainless steel exterior, rear side galvanized panel
- AISI-304 stainless steel interior, stamped bottom and rounded corners
- Reinforced base to drop and slide the barrels (50 or 30 liters)
- Doors with self closing system, blocked opening, magnetic gasket and possibility of changing the opening sense
- Worktop in stainless steel AISI-304 with drip perimeter
- AISI -304 base and legs
- Fan assisted evaporator, with epoxi anticorrosion coating.
- 40 Kg/m³ density polyurethane insulation, zero ODP and GWP
- Digital temperature control, optimized defrost, high-temperature condensation alarm. Efficient management of energy consumption
- Operating temperature ,32°C ambient

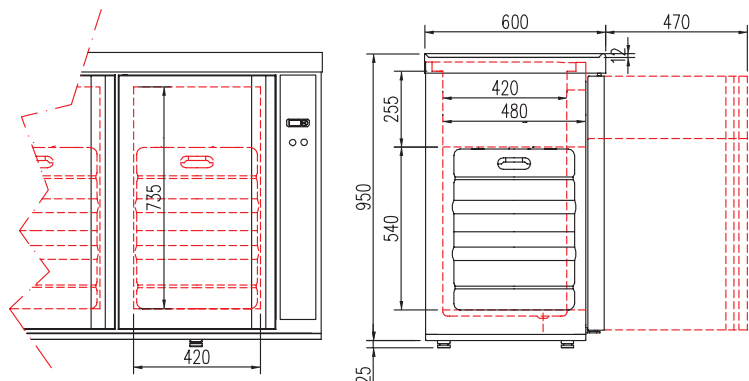
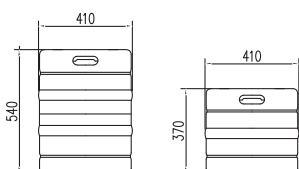



SD-100-I 1.547 €



SD-150-I 1.773 €

mod.	rango range °C	largo length (mm)	alto height (mm)	fondo depth (mm)	potencia frig frig power (W)	consumo consumption (W)	capacidad capacity (L)	voltaje voltage	refrigerante refrigerant
SD-100	+12°C +16°C	1010	800	545	300	290	63	230V-50Hz	R-290
SD-150	+10°C +16°C	1500	800	545	356	350	85	230V-50Hz	R-290

Características técnicas y constructivas sujetas a variación sin previo aviso.

- Exterior e interior en acero inox AISI-304
- Cuba interior, incorpora llave de paso para vaciado del agua
- Estante inferior para almacenamiento de botellas
- Patas regulables inox AISI-304
- Evaporador por placa fría
- Enfriamiento por baño en agua fría
- Unidad condensadora ventilada
- Aislamiento de poliuretano inyectado, densidad 40 Kg/m³, cero efectos ODP y GWP
- Control digital de temperatura, alarma por alta temperatura de condensación. Eficiente gestión del consumo de energía
- Temperatura de trabajo 32°C ambiente

We reserve the right to change specifications without prior notice.

- AISI-304 stainless steel exterior and interior
- Drain tap
- Bottom shelf for storage of bottles
- AISI -304 adjustable legs
- Cold plate evaporator
- Cold water bath system
- Fan assisted condenser unit
- 40 Kg/m³ density polyurethane insulation, zero ODP and GWP
- Digital temperature control, high-temperature condensation alarm.
- Efficient management of energy consumption
- Operating temperature 32°C ambient

230v 60Hz / 115v 60Hz consultar - consult

BAR EQUIPMENT • EQUIPAMIENTO PARA BARES



SD-100

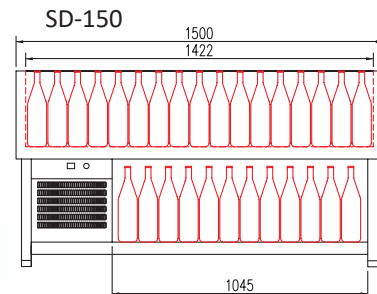
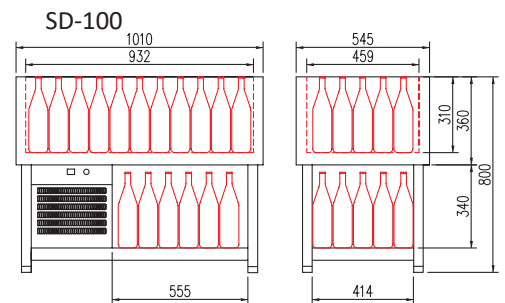

all photos must be considered as a reference - fotografías no contractuales



EAP-175V 1.616 €
EAPI-175V 1.720 €



EAP-100H 1.478 €
EAPI-100H 1.735 €

mod.	rango range °C	largo length (mm)	alto height (mm)	fondo depth (mm)	peso (vacío) weight (empty) Kg	potencia frig frig power W	consumo consumption W	capacidad capacity L	caudal grifo abierto open flow faucet (l/h) ΔT=10°C	voltaje voltage	refrigerante refrigerant
EAP-175V	+1°C +3°C	880	1140	560	103	485	366	175	110	230V-50Hz	R134a
EAP-100H	+1°C +3°C	1405	580	565	100	684	543	100	79	230V-50Hz	R134a

Temperatura máxima entrada del agua de red 15°C
Max inlet water temperature 15°C

Características técnicas y constructivas sujetas a variación sin previo aviso.

We reserve the right to change specifications without prior notice.

- **EAPI:** Exterior en acero inox AISI-304
- **EAP:** exterior en acero plastificado o acero plastificado
- Serpentín interior en acero inox AISI-304
- Aislamiento de poliuretano inyectado, densidad 40 Kg/m³, cero efectos ODP y GWP
- Llenado automático por boya, diámetro 1/2"
- Agitador de agua interior
- Control digital electrónico
- Encimera desmontable
- Rebosadero de seguridad diámetro 3/4"

- **EAPI:** Exterior in AISI-304 stainless steel
- **EAPI:** plasticed exterior
- AISI-304 stainless steel Internal coil and container
- 40 Kg/m³ density polyurethane insulation, zero ODP and GWP
- Automatic fill, float system, 1/2" diameter
- Interior water shaker
- Digital electronic control
- Detachable worktop
- Safety overflow, diameter 3/4"



sopORTE pared wall support 100 €

