





Vitrinas
CALOR



Baño María
pag 88- 91



Calor Seco
pag 92 - 95



BAÑO MARÍA
VITRINAS CALOR



Pag
88

CA-6

Baño María 1/3h 40



Pag
91

CA14-6

Baño María 1/4h 100



Pag
89

CA-6E

Baño María con estante 1/3h 40



Pag
91

CA13-5

Baño María 1/3h 100



Pag
90

CA11-3

Baño María 1/1 h100



Pag
92

SC-6

Calor seco 1/3h 40



Pag
94

SC-2ER

Calor seco 2 estantes



Pag
93

SC-6E

Calor seco con estante 1/3h 40



Pag
95

CA-150

Calor seco placa lisa



BAÑO MARÍA

VITRINA CALIENTE

Modelo
CA

- Control de temperatura mediante Termostato 20-90°C.
- Desagüe incorporado.
- Interruptores de funcionamiento impermeabilizados con fuelle exterior.
- Aislamiento Térmico de la vitrina con lana de roca Euro Clase A1.
- Puertas Correderas en metacrilato.
- Cuba Interior fabricada en Acero Inoxidable AISI-304.
- Iluminación LED.
- Cristal templado de seguridad.

RECOMENDABLE
NO SOBREPASAR LOS 70°C.

Cubetas
INCLUIDAS



Fabricación Especial
A MEDIDA
Pídanos Presupuesto

SUPLEMENTO CUBETA
MELAMINA 1/3 h40
4 uds. 6 uds. 8 uds.
48 € 72 € 96 €



Iluminación
LED



CA-6 NOGAL



Bandeja Auxiliar
INCLUIDA



CRISTAL RECTO | CRISTAL CURVO | Temperatura de Trabajo +20°/+90°

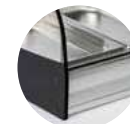

PLATA



NOGAL



BLANCO



NEGRO

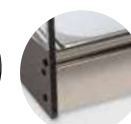

ACERO INOXIDABLE

CRISTAL CURVO

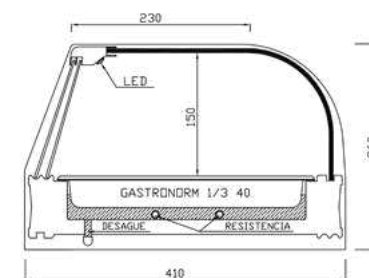

CRISTAL RECTO

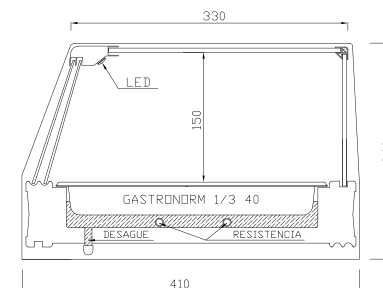

Modelo	Largo	Fondo	Alto	Cubetas (Incluidas)	Potencia	Plata/Nogal/Blanco/Negro	Acero Inoxidable
CA-4 CA-4R	810	410	260	4	704 W / 230 V	760 €	850 €
CA-6 CA-6R	1160	410	260	6	1006 W / 230 V	830 €	930 €
CA-8 CA-8R	1516	410	260	8	1308 W / 230 V	900 €	1.010 €

- Vitrina caliente de **BAÑO MARÍA** Ideal para el exposición de tapas calientes en Cubeta Gastronorm incluidas en la vitrina.
- Disponible con bandeja plana en Acero Inoxidable para utilizarla sin cubetas o como **EXPOSITOR NEUTRO**.

BAÑO MARÍA VITRINA CALIENTE



Estante intermedio

Modelo
CA E

- Cristal Templado de Seguridad.
- Estante intermedio.

CA-6E NOGAL

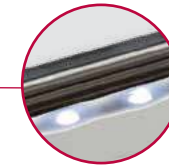

Iluminación
LED

CRISTAL CURVO

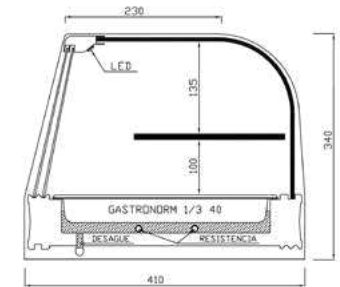

Cubetas
INCLUIDAS



Fabricación Especial
A MEDIDA

Pídanos Presupuesto

SUPLEMENTO CUBETA

MELAMINA 1/3 h40

4 uds. 6 uds. 8 uds.

48 € 72 € 96 €



Bandeja Auxiliar
INCLUIDA



CRISTAL RECTO

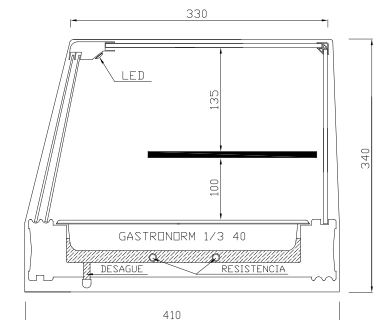

SISTEMA DE CALOR MEDIANTE RESISTENCIA
EN ACERO INOXIDABLE 10 mm.

Modelo	Largo	Fondo	Alto	Cubetas (Incluidas)	Potencia	Plata/Nogal/Blanco/Negro	Acero Inoxidable
CA-4E CA-4ER	810	410	340	4	704 W / 230 V	890 €	995 €
CA-6E CA-6ER	1160	410	340	6	1006 W / 230 V	955 €	1.070 €
CA-8E CA-8ER	1516	410	340	8	1308 W / 230 V	1.030 €	1.150 €



Modelo

CAL11 CAL14 CAL13

- Control de temperatura mediante Termostato 20-90°C.
- Desagüe incorporado.
- Interruptores de funcionamiento impermeabilizados con fuelle exterior.
- Aislamiento Térmico de la vitrina con lana de roca Euro Clase A1.
- Puertas Correderas en metacrilato.
- Cuba interior fabricada en Acero Inoxidable AISI-304.
- Iluminación LED.

CAL11-3



CUBETAS GN 1/1 h100

530 x 325 x100

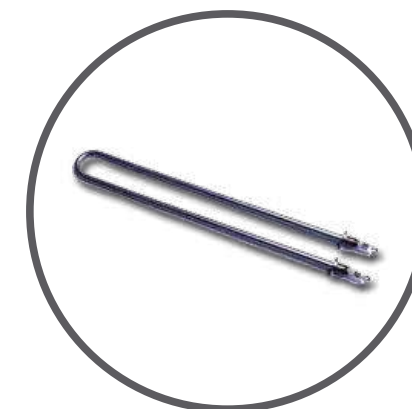
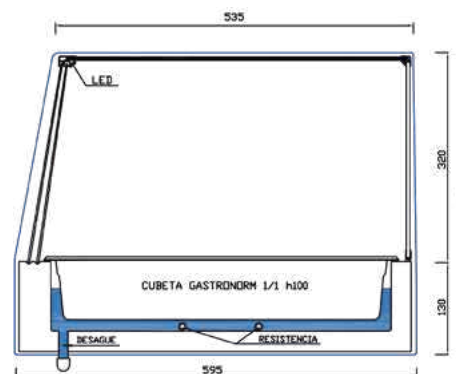

SISTEMA DE CALOR MEDIANTE RESISTENCIA
EN ACERO INOXIDABLE 10 mm.

Modelo	Largo	Fondo	Alto	Cubetas	Potencia	PVP
CAL11-3	1080	595	450	3	1006 W / 230 V	1.280 €
CAL11-4	1405	595	450	4	1308 W / 230 V	1.450 €



CAL14-6

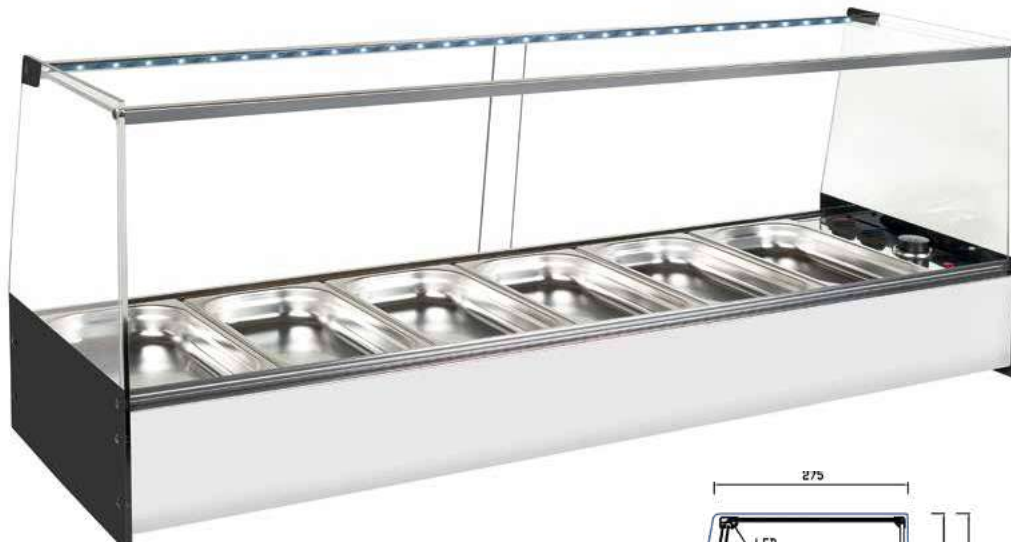

CUBETAS GN 1/4 h100
162 x 265 x100

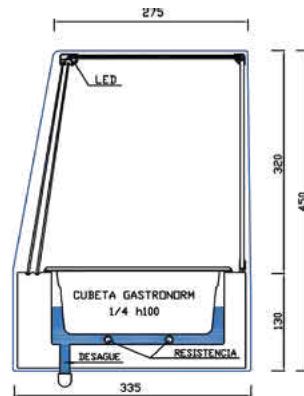

CAL13-5



CUBETAS GN 1/3 h100
325 x175 x100

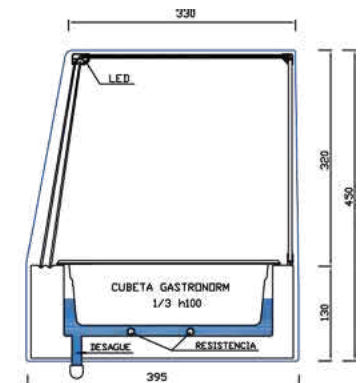

Modelo	Largo	Fondo	Alto	Cubetas	Potencia	PVP
CAL14-6	1078	335	450	6	1006 W / 230 V	925 €
CAL14-8	1400	335	450	8	1308 W / 230 V	1.060 €

Modelo	Largo	Fondo	Alto	Cubetas	Potencia	PVP
CAL13-4	810	395	450	4	707 W / 230 V	1.100 €
CAL13-6	1160	395	450	6	1006 W / 230 V	1.240 €
CAL13-8	1516	395	450	8	1308 W / 230 V	1.475 €



CALOR SECO

VITRINA CALIENTE

Modelo
SC

- Control de temperatura mediante Termostato 20-90°C.
- Interruptores de funcionamiento impermeabilizados con fuele exterior.
- Aislamiento Térmico de la vitrina con lana de roca Euro Clase A1.
- Puertas Correderas en metacrilato.
- Cuba Interior fabricada en Acero Inoxidable AISI-304.
- Iluminación LED.
- Cristal templado de seguridad.

RECOMENDABLE
NO SOBREPASAR LOS 70°C.

CRISTAL RECTO | CRISTAL CURVO | Temperatura de Trabajo +20°/+90°



Iluminación
LED

SC-6 NOGAL



Cubetas
INCLUIDAS

Fabricación Especial
A MEDIDA

Pídanos Presupuesto

SUPLEMENTO CUBETA

MELAMINA 1/3 h40

4 uds. 6 uds.

48 € 72 €



CRISTAL CURVO

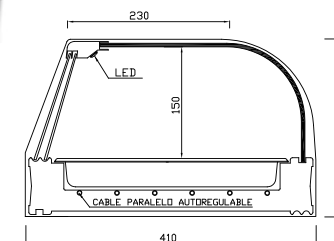

CRISTAL RECTO

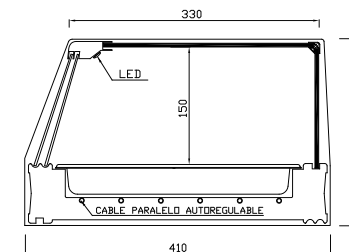

SISTEMA DE CALOR MEDIANTE
CABLE PARALELO AUTORREGULABLE

Modelo	Largo	Fondo	Alto	Cubetas (Incluidas)	Potencia	Plata/Nogal/Blanco/Negro	Acero Inoxidable
SC-4	810	410	250	4	170 W / 230 V	740 €	830 €
SC-6	1160	410	250	6	225 W / 230 V	810 €	910 €

CALOR SECO

VITRINA CALIENTE

Estante intermedio



Modelo
SC-E

- Cristal Templado de Seguridad.
- Estante intermedio.

SC-6E NOGAL

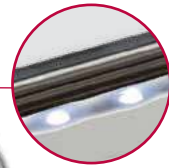

Iluminación
LED

CRISTAL CURVO

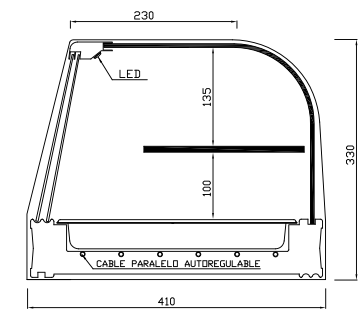

CRISTAL RECTO

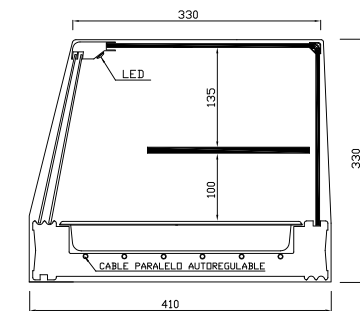

Cubetas
INCLUIDAS



Fabricación Especial
A MEDIDA

Pídanos Presupuesto

SUPLEMENTO CUBETA
MELAMINA 1/3 h40
4 uds. 6 uds.
48 € 72 €



Modelo	Largo	Fondo	Alto	Cubetas (Incluidas)	Potencia	Plata/Nogal/Blanco/Negro	Acero Inoxidable
SC-4E SC-4ER	810	410	330	4	170 W / 230 V	850 €	950 €
SC-6E SC-6ER	1160	410	330	6	225 W / 230 V	930 €	1.070 €



BAÑO-MARÍA / CALOR SECO

VITRINAS CALIENTE

Tres Alturas

CRISTAL RECTO



CRISTAL CURVO



Temperatura de Trabajo



+20°/+90°

Modelo

CA-2ER SC-2ER

- Control de temperatura mediante Termostato 20-90°C.
- Interruptores de funcionamiento impermeabilizados con fuelle exterior.
- Aislamiento Térmico de la vitrina con lana de roca Euro Clase A1.
- Puertas Correderas en metacrilato.
- Cuba Interior fabricada en Acero Inoxidable AISI-304.
- Iluminación LED en cada estante.

RECOMENDABLE
NO SOBREPASAR LOS 70°C.

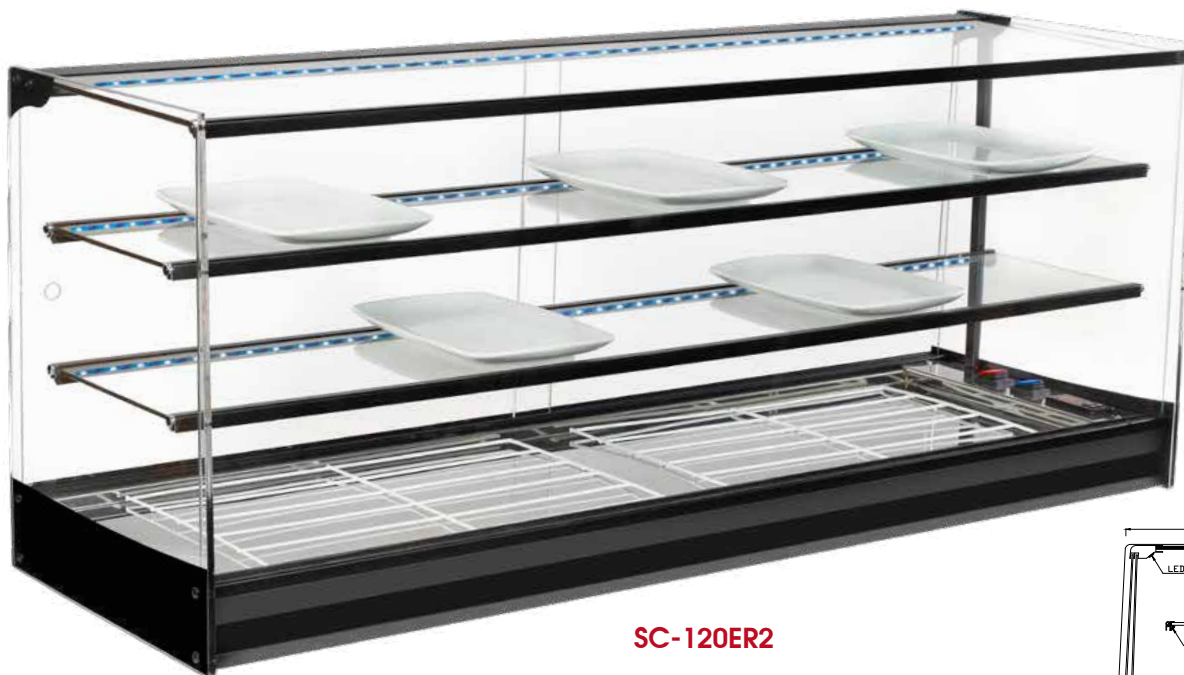

SC-120ER2

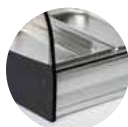

PLATA



NOGAL



BLANCO



NEGRO

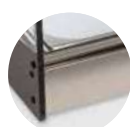

ACERO INOXIDABLE

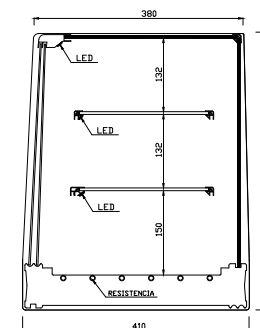
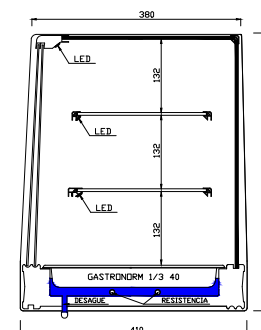

Modelo	Largo	Fondo	Alto	Cubetas	Agua	Potencia	Plata/Nogal/Blanco/Negro	Acero Inox.
SC-2ER4	810	410	500	4	NO	170 W / 230 V	1.060 €	1.180 €
SC-2ER6	1160	410	500	6	NO	225 W / 230 V	1.160 €	1.300 €
SC-2ER120	1216	410	500	NO	NO	225 W / 230 V	1.190 €	1.330 €
SC-2ER150	1516	410	500	NO	NO	278 W / 230 V	1.420 €	1.590 €
CA-2ER4	810	410	500	4	SI	704 W / 230 V	1.100 €	1.235 €
CA-2ER6	1160	410	500	6	SI	1006 W / 230 V	1.210 €	1.355 €

CRISTAL
RECTO



CRISTAL
CURVO



Temperatura
de Trabajo



+20°/+90°

Accesorios
disponibles



Pag
76

CALOR SECO

VITRINA CALIENTE

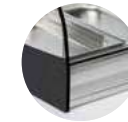

PLATA



NOGAL



BLANCO



NEGRO

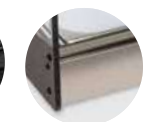

ACERO
INOXIDABLE

CA 150

Iluminación
LED



SISTEMA DE CALOR MEDIANTE
CABLE PARALELO AUTORREGULABLE



Modelo CA 150

- Vitrina caliente de bandeja plana ideal para la exposición de pizza, bocadillos, bollería, pinchos, etc.
- Cristal curvo templado de seguridad.
- Puertas abatibles en metacrilato.
- Construida totalmente en Acero Inoxidable AISI-304.
- Control de temperatura mediante termostato +20C° / +90°C.
- Aislamiento térmico de la vitrina con lana de roca Euro Clase A1.
- Iluminación LED.
- Esta vitrina no viene preparada para utilizarla al baño maría.

RECOMENDABLE
NO SOBREPASAR LOS 70°C.



CRISTAL CURVO

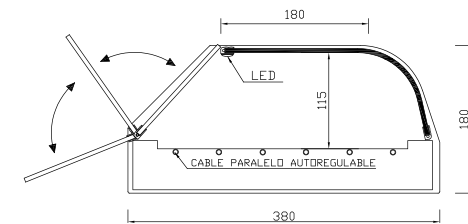

CRISTAL RECTO

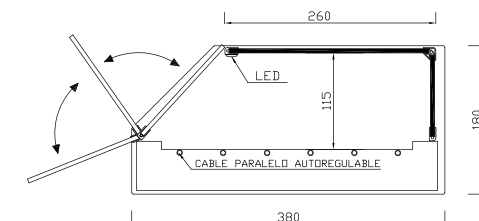

Modelo	Largo	Fondo	Alto	Potencia	PVP
CA-120 CA-120R	1200	180	380	225 W / 230 V	900 €
CA-150 CA-150R	1500	180	380	278 W / 230 V	1.045 €
CA-200 CA-200R	2000	180	380	369 W / 230 V	1.224 €

Fabricación Especial
A MEDIDA
Pídanos Presupuesto