



CORECO



GAMA AMERICANA AMERICAN RANGE

BAJO COCINA - UNDER BROILER

Pag. **234-325** Mesa fría GN 2/1, refrigeración BAJO COCINA
GN 2/1 counter, chiller UNDER BROILER

MESA FRÍA - PREPARATION COUNTER

Pag. **236-237** Mesa fría refrigeración y congelados
Refrigerated counter, chiller and freezer

Pag. **238-239** Mesa fría puerta de cristal
Glass door refrigerated counter

Pag. **240-243** Mesa fría preparación
Preparation refrigerated counter

ARMARIOS - CABINETS

Pag. **244-249** Armario GN 2/1, refrigeración y congelados
GN 2/1 cabinet, chiller and freezer



KBR-47 3.252 €

KBR-65 4.242 €

KBR-83 5.054 €

mod.	rango range °C	largo length (mm)	alto height (mm)	fondo depth (mm)	volumen capacity (L)	voltaje voltage	refrigerante refrigerant	potencia frig. frig. power W	potencia power W	CCE EEC 2015/1094 EN16825	clase climate 2015/1094 EN16825
KBR-47	-2°C +8°C	1210	600	700	169	230V-50Hz	R290	502	200	C	5 40°C 40%
KBR-65	-2°C +8°C	1660	600	700	264	230V-50Hz	R290	502	220	D	5 40°C 40%
KBR-83	-2°C +8°C	2110	600	700	359	230V-50Hz	R290	502	226	D	5 40°C 40%

Características técnicas y constructivas sujetas a variación sin previo aviso.

We reserve the right to change specifications without prior notice.

- Exterior en acero inox AISI-304, excepto el respaldo y fondo
- Interior en acero inox AISI-304, con aristas curvas y fondo embutido
- Cajoneras refrigeradas inox desmontables sobre guías inox telescópicas, sistema auto-cierre de serie
- Encimera de acero inox AISI-304 con frente recto (opcional con peto sanitario 100 mm)
- Posibilidad de fabricar encimera especial a medida
- Pies en tubo de acero inox ajustables en altura 95- 135 mm
- Unidad condensadora ventilada y extraíble
- Evaporador sistema tiro forzado, con recubrimiento epoxi anticorrosión
- Evaporación automática del agua de descarche
- Aislamiento de poliuretano inyectado, densidad 40 Kg/m³, cero GWP y cero efecto ODP
- Control digital de última generación, monitorización en tiempo real, anticipación a incidencias, reducción de averías y simplificación del mantenimiento y uso por APP en smartphone o Tablet
- Condiciones de trabajo a 40°C 40% ambiente

- AISI-304 stainless steel exterior, except rear side and base
- AISI-304 stainless steel interior, stamped bottom and rounded corners
- Stainless steel drawers with telescopic stainless steel slides for complete opening, self-closing system as standard
- AISI-304 stainless steel worktop, with 90° front (optional with 100 mm sanitary upstand)
- Worktop can be customized on demand
- AISI -304 adjustable legs, 95 to 135 mm
- Removable and fan assisted condenser unit
- Fan assisted evaporator, with epoxi anticorrosion coating.
- Automatic evaporation of defrost water
- 40 Kg/m³ density polyurethane insulation, zero GWP and zero ODP effect
- Next-generation digital control, real-time monitoring, issue anticipation, reduced breakdowns, simplified maintenance, and APP-based operation via smartphone or tablet.
- Operating 40°C 40% ambient

OPCIONES	OPTIONS	€
motor lado izquierdo	left side motor	77 €
encimera con peto	worktop with splash-back	0 €
set 4 ruedas	set 4 wheels	112 €
set 6 ruedas	set 6 wheels	166 €
respaldo inox	SS rear side	consultar
tropicalizado 43°C	tropicalized 43 °C	consultar
230V 60HZ / 115V 60HZ	230V 60HZ / 115V 60HZ	consultar
APPC	HACCP	incluido

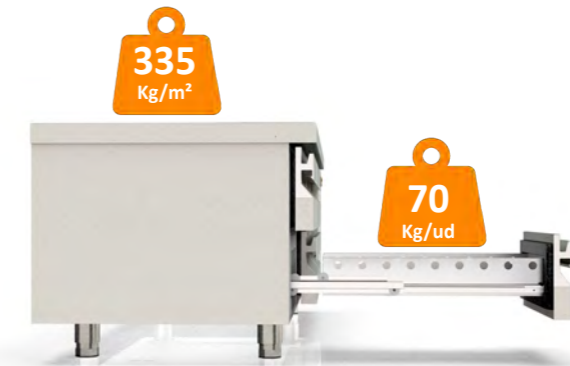
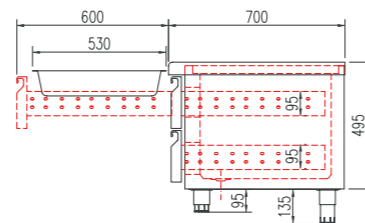

KBR-83





SD-27 1.745 €
SDN-27 2.598 €

SD-48 2.321 €
SDN-48 3.171 €

SD-60 2.528 €
SDN-60 3.529 €

SD-72 2.874 €

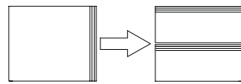

SD: Incremento precio por cambio de puerta a cajonera doble, sistema autocierre
SD: Door to double drawers set, soft-closing system, increase of price

635 €

Cajones sólo modelos -2°C +8°C
Drawers only for -2°C +8°C

mod.	rango range	largo length (mm) (inch)	alto height (mm) (inch)	fondo depth (mm) (inch)	estantes shelves uds	volumen capacity (L)	voltaje voltage	refrigerante refrigerant	potencia frig. frig. power W	potencia power W	CCE EEC 2015/1094 EN16825	clase climate 2015/1094 EN16825
SD-27	-2°C +8°C	701 27 ³ / ₅	915 36 ¹ / ₃₂	805 32 ¹ / ₉	2	204	230V-50Hz	R290	502	250	C	5 40°C 40%
SD-48	-2°C +8°C	1228 48 ¹ / ₃	915 36 ¹ / ₃₂	805 32 ¹ / ₉	4	394	230V-50Hz	R290	502	275	C	5 40°C 40%
SD-60	-2°C +8°C	1532 60 ⁵ / ₁₆	915 36 ¹ / ₃₂	805 32 ¹ / ₉	4	500	230V-50Hz	R290	845	440	D	5 40°C 40%
SD-72	-2°C +8°C	1837 72 ¹ / ₃	915 36 ¹ / ₃₂	805 32 ¹ / ₉	6	606	230V-50Hz	R290	845	450	D	5 40°C 40%
SDN-27	-20°C -15°C	701 27 ³ / ₅	915 36 ¹ / ₃₂	805 32 ¹ / ₉	2	204	230V-50Hz	R290	606	560	D	4 30°C 55%
SDN-48	-20°C -15°C	1228 48 ¹ / ₃	915 36 ¹ / ₃₂	805 32 ¹ / ₉	4	394	230V-50Hz	R290	907	730	D	4 30°C 55%
SDN-60	-20°C -15°C	1532 60 ⁵ / ₁₆	915 36 ¹ / ₃₂	805 32 ¹ / ₉	4	500	230V-50Hz	R290	907	730	D	4 30°C 55%

Características técnicas y constructivas sujetas a variación sin previo aviso.

- Exterior e interior en acero, excepto respaldo y fondo
- Puertas de apertura reversible, con sistema de cierre automático y burlete magnético (permanece abierta al superar los 90° de apertura)
- Encimera inox AISI-304
- Estantes interiores de alambre en acero plastificado, regulables en altura
- Ruedas de serie (2 con freno + 2 sin freno)
- Unidad condensadora ventilada
- Evaporador sistema tiro forzado, con recubrimiento epoxi anticorrosión
- Evaporación automática del agua de descarche
- Aislamiento de poliuretano inyectado, densidad 40 Kg/m³, cero GWP y cero efecto ODP
- Control digital de temperatura, descarches optimizados, alarma por alta temperatura de condensación. Eficiente gestión del consumo de energía
- Temperatura de trabajo a 38°C ambiente

We reserve the right to change specifications without prior notice.

- Stainless steel interior and exterior, except rear side and base
- Doors with self closing system, blocked opening, magnetic gasket and possibility of changing the opening sense
- AISI 304 stainless steel worktop
- Shelves made of plasticized steel wire, height adjustable
- Castors as standard (2 with brakes + 2 without)
- Fan assisted condenser unit
- Fan assisted evaporator, with epoxi anticorrosion coating.
- Automatic evaporation of defrost water
- 40 Kg/m³ density polyurethane insulation, zero GWP and zero ODP effect
- Digital temperature control, optimized defrost, high-temperature condensation alarm. Efficient management of energy consumption
- Operating temperature, 38°C ambient



SD-72
con cajoneras opcionales
with optional drawers sets

Puertas con doble bisagra
Double hinged doors



OPCIONES	OPTIONS	€
encimera con peto	worktop with splash-back	consultar
set 4 patas	set 4 legs	0 €
set 6 patas	set 6 legs	0 €
registrador de alarmas HACCP	HACCP alarm recorder	consultar
respaldo inox	SS rear side	consultar
tropicalizado 43°C	tropicalized 43 °C	consultar
230V 60HZ / 115V 60HZ	230V 60HZ / 115V 60HZ	consultar
APPCC	HACCP	consultar



SD-27



SD-48



SD-72



SDV-27 2.028 €



SDV-48 2.790 €



SDV-60 3.081 €



SDV-72 3.614 €

mod.	rango range	largo length (mm) (inch)	alto height (mm) (inch)	fondo depth (mm) (inch)	estantes shelves uds	volumen capacity (L)	voltaje voltage	refrigerante refrigerant	potencia frig. frig. power W	potencia power W	CCE EEC 2015/1094 EN16825	clase climate 2015/1094 EN16825
SDV-27	-2°C +8°C 28°F 46°F	701 27 3/5	915 36 1/32	805 32 1/9	2	204	230V-50Hz	R290	502	271	D	5 40°C 40%
SDV-48	-2°C +8°C 28°F 46°F	1228 48 1/3	915 36 1/32	805 32 1/9	4	394	230V-50Hz	R290	502	287	D	5 40°C 40%
SDV-60	-2°C +8°C 28°F 46°F	1532 60 5/16	915 36 1/32	805 32 1/9	4	500	230V-50Hz	R290	845	452	E	5 40°C 40%
SDV-72	-2°C +8°C 28°F 46°F	1837 72 1/3	915 36 1/32	805 32 1/9	6	606	230V-50Hz	R290	845	467	E	5 40°C 40%

Características técnicas y constructivas sujetas a variación sin previo aviso.

- Exterior e interior en acero, excepto respaldo y fondo
- Puertas de doble cristal, sobre marco de aluminio
- Puertas de apertura reversible, con sistema de cierre automático y burlete magnético (permanece abierta al superar los 90° de apertura)
- Encimera inox AISI-304
- Estantes interiores de alambre en acero plastificado, regulables en altura
- Ruedas de serie (2 con freno + 2 sin freno)
- Unidad condensadora ventilada
- Evaporador sistema tiro forzado, con recubrimiento epoxi anticorrosión
- Evaporación automática del agua de descarche
- Aislamiento de poliuretano inyectado, densidad 40 Kg/m³, cero GWP y cero efecto ODP
- Control digital de temperatura, descarches optimizados, alarma por alta temperatura de condensación. Eficiente gestión del consumo de energía
- Temperatura de trabajo a 32°C ambiente

We reserve the right to change specifications without prior notice.

- Stainless steel interior and exterior, except rear side and base
- Double glazed doors, with aluminium frame
- Doors with self closing system, blocked opening, magnetic gasket and possibility of changing the opening sense
- AISI 304 stainless steel worktop
- Shelves made of plasticized steel wire, height adjustable
- Castors as standard (2 with brakes + 2 without)
- Fan assisted condenser unit
- Fan assisted evaporator, with epoxi anticorrosion coating.
- Automatic evaporation of defrost water
- 40 Kg/m³ density polyurethane insulation, zero GWP and zero ODP effect
- Digital temperature control, optimized defrost, high-temperature condensation alarm. Efficient management of energy consumption
- Operating temperature, 32°C ambient

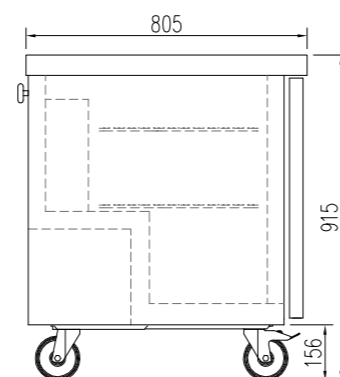

SDV-72

Puertas con doble bisagra
Double hinged doors

OPCIONES	OPTIONS	€
encimera con peto	worktop with splash-back	consultar
set 4 patas	set 4 legs	0 €
set 6 patas	set 6 legs	0 €
registrador de alarmas HACCP	HACCP alarm recorder	consultar
respaldo inox	SS rear side	consultar
tropicalizado 43°C	tropicalized 43 °C	consultar
230V 60Hz / 115V 60Hz	230V 60Hz / 115V 60Hz	consultar
APPCC	HACCP	consultar



SDV-27



SDV-48



SDT-27-8 1.979 €



SDT-48-12 2.705 €



SDT-60-16 3.015 €



SDT-72-18 3.439 €

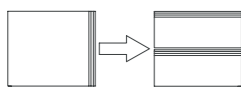

Incremento precio por cambio de puerta a cajonera doble, sistema autocierre
Door to double drawers set, soft-closing system, increase of price

635 €



Cubetas GN y perfiles divisorios NO incluidos en el precio, ver página 554
GN containers and dividers NOT included in price, see page 554

mod.	rango range	largo length (mm) (inch)	fondo depth (mm) (inch)	perfiles GN GN supports	estantes shelves uds	encimera worktop GN1/6-100	volumen capacity (L)	voltaje voltage	refrigerante refrigerant	potencia frig. frig. power W	potencia power W	
SDT-27-8	0°C +8°C	32°F 46°F	701 27 ³ / ₅	805 32 ¹ / ₉	1	2	8	204	230V-50Hz	R290	502	264
SDT-48-12	0°C +8°C	32°F 46°F	1228 48 ¹ / ₃	805 32 ¹ / ₉	1	4	12	394	230V-50Hz	R290	502	225
SDT-60-16	0°C +8°C	32°F 46°F	1532 60 ⁵ / ₁₆	805 32 ¹ / ₉	1	4	16	500	230V-50Hz	R290	845	452
SDT-72-18	0°C +8°C	32°F 46°F	1837 72 ¹ / ₃	805 32 ¹ / ₉	1	6	18	606	230V-50Hz	R290	845	467

Características técnicas y constructivas sujetas a variación sin previo aviso.

- Exterior e interior en acero, excepto respaldo y fondo
- Puertas de apertura reversible, con sistema de cierre automático y burlete magnético (permanece abierta al superar los 90° de apertura)
- Encimera inox AISI 304 con tabla de polietileno desmontable, color blanco
- Estantes interiores de alambre en acero plastificado, regulables en altura
- Capacidad cubetas GN en la encimera
- Cubierta inox AISI-304, aislada, abatible sobre alojamiento cubetas
- Estantes interiores de alambre en acero plastificado, regulables en altura
- Ruedas de serie (2 con freno + 2 sin freno)
- Unidad condensadora ventilada
- Evaporador sistema tiro forzado, con recubrimiento epoxi anticorrosión
- Evaporación automática del agua de descarche
- Aislamiento de poliuretano inyectado, densidad 40 Kg/m³, cero GWP y cero efecto ODP
- Control digital de temperatura, descarches optimizados, alarma por alta temperatura de condensación. Eficiente gestión del consumo de energía
- Temperatura de trabajo 0°C +8°C a 38°C ambiente

We reserve the right to change specifications without prior notice.

- Stainless steel interior and exterior, except rear side and base
- Doors with self closing system, blocked opening, magnetic gasket and possibility of changing the opening sense
- AISI-304 stainless steel worktop, with detachable white polyethylene table
- Shelves made of plasticized steel wire, height adjustable
- GN capacity in the worktop
- AISI 304 stainless steel lid, isolated and hinged
- Shelves made of plasticized steel wire, height adjustable
- Castors as standard (2 with brakes + 2 without)
- Fan assisted condenser unit
- Fan assisted evaporator, with epoxi anticorrosion coating.
- Automatic evaporation of defrost water
- 40 Kg/m³ density polyurethane insulation, zero GWP and zero ODP effect
- Digital temperature control, optimized defrost, high-temperature condensation alarm. Efficient management of energy consumption
- Operating temperature 0°C +8°C, 38°C ambient



SDT-72-18
con cajonera opcional
with optional drawer set

Puertas con doble bisagra y burlete desmontable
Double hinged doors and detachable sgasket

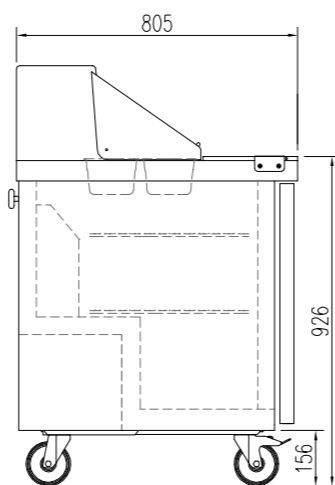

SDT-27-8



SDT-72-18

Capacidad - GN 1/6-100 - Capacity

SDT-27-8

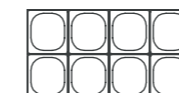

SDT-48-12

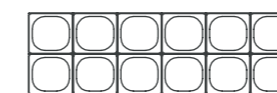

SDT-60-16

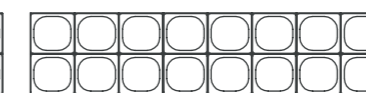

SDT-72-18

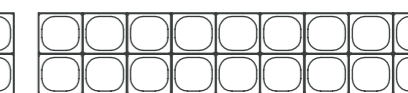



SDTP-27-12 2.162 €



SDTP-48-18 2.827 €



SDTP-60-24 3.115 €



SDTP-72-27 3.563 €

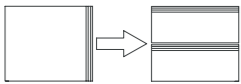

Incremento precio por cambio de puerta a cajonera doble, sistema autocierre
Door to double drawers set, soft-closing system, increase of price

635 €



Cubetas GN y perfiles divisorios NO incluidos en el precio, ver página 554
GN containers and dividers NOT included in price, see page 554

mod.	rango range	largo length (mm) (inch)	fondo depth (mm) (inch)	perfiles GN GN supports	estantes shelves uds	encimera worktop GN1/6-100	volumen capacity (L)	voltaje voltage	refrigerante refrigerant	potencia frig. frig. power W	potencia power W
SDTP-27-12	0°C +8°C 32°F 46°F	701 27 ³ / ₅	805 32 ¹ / ₉	2	2	12	204	230V-50Hz	R290	502	264
SDTP-48-18	0°C +8°C 32°F 46°F	1228 48 ¹ / ₃	805 32 ¹ / ₉	2	4	18	394	230V-50Hz	R290	502	225
SDTP-60-24	0°C +8°C 32°F 46°F	1532 60 ⁵ / ₁₆	805 32 ¹ / ₉	2	4	24	500	230V-50Hz	R290	845	452
SDTP-72-27	0°C +8°C 32°F 46°F	1837 72 ¹ / ₃	805 32 ¹ / ₉	2	6	27	606	230V-50Hz	R290	845	467

Características técnicas y constructivas sujetas a variación sin previo aviso.

- Exterior e interior en acero, excepto respaldo y fondo
- Puertas de apertura reversible, con sistema de cierre automático y burlete magnético (permanece abierta al superar los 90° de apertura)
- Encimera inox AISI 304 con tabla de polietileno desmontable, color blanco
- Estantes interiores de alambre en acero plastificado, regulables en altura
- Capacidad cubetas GN en la encimera
- Cubierta inox AISI-304, aislada, abatible sobre alojamiento cubetas
- Estantes interiores de alambre en acero plastificado, regulables en altura
- Ruedas de serie (2 con freno + 2 sin freno)
- Unidad condensadora ventilada
- Evaporador sistema tiro forzado, con recubrimiento epoxi anticorrosión
- Evaporación automática del agua de descarche
- Aislamiento de poliuretano inyectado, densidad 40 Kg/m³, cero GWP y cero efecto ODP
- Control digital de temperatura, descarches optimizados, alarma por alta temperatura de condensación. Eficiente gestión del consumo de energía
- Temperatura de trabajo 0°C +8°C a 38°C ambiente

We reserve the right to change specifications without prior notice.

- Stainless steel interior and exterior, except rear side and base
- Doors with self closing system, blocked opening, magnetic gasket and possibility of changing the opening sense
- AISI-304 stainless steel worktop, with detachable white polyethylene table
- Shelves made of plasticized steel wire, height adjustable
- GN capacity in the worktop
- AISI 304 stainless steel lid, isolated and hinged
- Shelves made of plasticized steel wire, height adjustable
- Castors as standard (2 with brakes + 2 without)
- Fan assisted condenser unit
- Fan assisted evaporator, with epoxi anticorrosion coating.
- Automatic evaporation of defrost water
- 40 Kg/m³ density polyurethane insulation, zero GWP and zero ODP effect
- Digital temperature control, optimized defrost, high-temperature condensation alarm. Efficient management of energy consumption
- Operating temperature 0°C +8°C, 38°C ambient



SDTP-72-27
con cajonera opcional
with optional drawer set



Puertas con doble bisagra
Double hinged doors

OPCIONES	OPTIONS	€
set 4 patas	set 4 legs	0 €
set 6 patas	set 6 legs	0 €
registrador de alarmas HACCP	HACCP alarm recorder	consultar
respaldo inox	SS rear side	consultar
tropicalizado 43°C	tropicalized 43 °C	consultar
230V 60Hz / 115V 60Hz	230V 60Hz / 115V 60Hz	consultar
APCC	HACCP	consultar

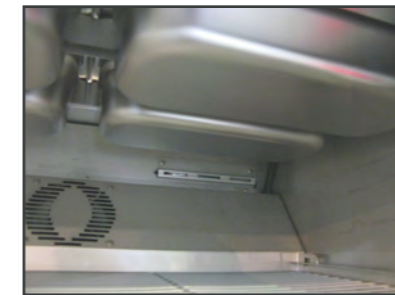
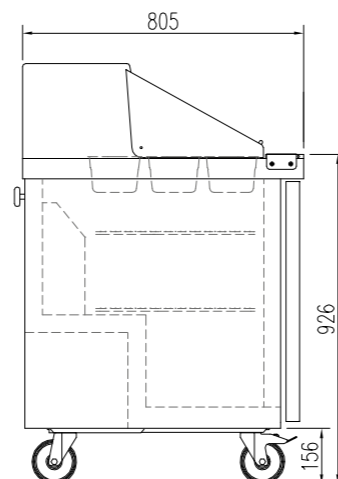

SDTP-27-12



SDTP-72-27

Capacidad - GN 1/6-100 - Capacity

SDTP-27-12	SDTP-48-18	SDTP-60-24	SDTP-72-27



SDTP-27-9-LGL 3.234 €



SDTP-48-18-LGL 3.963 €

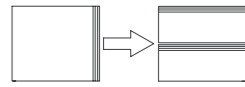

Incremento precio por cambio de puerta a cajonera doble, sistema autocierre
Door to double drawers set, soft-closing system, increase of price

635 €



Cubetas GN y perfiles divisorios NO incluidos en el precio, ver página 554
GN containers and dividers NOT included in price, see page 554

mod.	rango range	largo length (mm) (inch)	fondo depth (mm) (inch)	perfiles GN GN supports	estantes shelves uds	encimera worktop GN1/6-100	volumen capacity (L)	voltaje voltage	refrigerante refrigerant	potencia frig. frig. power W	potencia power W	
SDTP-27-9-LGL	0°C +8°C	32°F 46°F	701 27 ³ / ₅	830 32 ² / ₃	2	2	9	204	230V-50Hz	R290	502	275
SDTP-48-18-LGL	0°C +8°C	32°F 46°F	1228 48 ¹ / ₃	830 32 ² / ₃	2	4	18	394	230V-50Hz	R290	502	286

Características técnicas y constructivas sujetas a variación sin previo aviso.

- Exterior en acero, incluido el respaldo
- Interior en acero, con aristas curvas y fondo embutido
- Puertas de apertura reversible, con sistema de cierre automático y burlete magnético (permanece abierta al superar los 90° de apertura)
- Encimera inox con capacidad cubetas GN (ver detalle)
 - Tabla de corte en polietileno
 - Perfiles divisorios fijos (desmontable para limpieza) para apoyo de las cubetas
 - Robusta estructura elevable, con doble cristal para mantener la temperatura del área de cubetas
 - Máxima visibilidad del producto, LED 6500 K
 - Opción LED 3000 K (luz cálida) o Rosa al mismo precio
 - Sellado del perímetro de la cubierta por burletes
- Sistema de pistones y amortiguadores para compensar el peso
- Estantes interiores de alambre en acero plastificado, regulables en altura
- Ruedas de serie (2 con freno + 2 sin freno)
- Unidad condensadora ventilada
- Evaporador sistema tiro forzado, con recubrimiento epoxi anticorrosión
- Evaporación automática del agua de descarche
- Aislamiento de poliuretano inyectado, densidad 40 Kg/m³, cero efectos ODP y GWP
- Control digital de temperatura, descarches optimizados, alarma por alta temperatura de condensación. Eficiente gestión del consumo de energía
- Temperatura de trabajo a 32°C ambiente

We reserve the right to change specifications without prior notice.

- Stainless steel exterior, rear side included
- Stainless steel interior, stamped bottom and rounded corners
- Doors with self closing system, blocked opening, magnetic gasket and possibility of changing the opening sense
- AISI-304 worktop, capacity for GN containers (see detail)
 - Polyethylene cutting table
 - Fixed pan dividers (detachable for cleaning)
 - Heavy-duty double liftable glass lid to keep temperature in the GN pans
 - Maximum product visibility by 6500 K LED
 - Optional 300 K LED (soft light) or Pink, same price
 - Perimetral gasket around the lid structure
- Piston system to help the opening /closing of the structure
- Shelves made of plasticized steel wire, height adjustable
- Castors as standard (2 with brakes + 2 without)
- Removable and fan assisted condenser unit
- Fan assisted evaporator, with epoxi anticorrosion coating.
- Automatic evaporation of defrost water
- 40 Kg/m³ density polyurethane insulation, zero ODP and GWP
- Digital temperature control, optimized defrost, high-temperature condensation alarm. Efficient management of energy consumption
- Operating temperature 32°C ambient

Puertas con doble bisagra y burlete desmontable
Double hinged doors and detachable sgasket

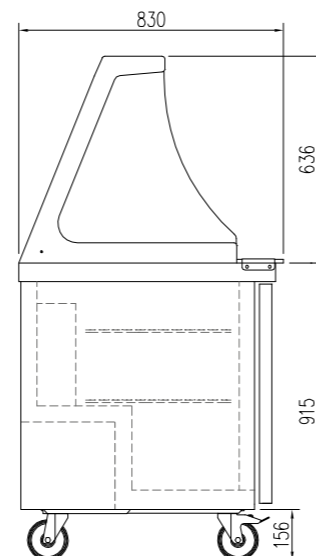

SDTP-48-18-LGL

SDTP-48-18-LGL
con cajonera opcional
with optional drawer set

DTP-48-18-LGL



UPR-27	2.619 €	UPR-27-2	2.810 €	UPR-55	3.500 €	UPR-55-4	3.939 €	UPR-82	4.579 €
UPL-27	3.130 €	UPL-27-2	3.360 €	UPL-55	4.120 €	UPL-55-4	4.875 €	UPL-82	5.464 €

mod.	rango range	largo length (mm) (inch)	alto height (mm) (inch)	fondo depth (mm) (inch)	estantes shelves GN 2/1	volumen capacity (L)	voltaje voltage	refrigerante refrigerant	potencia frig. frig. power W	potencia power W	CCE EEC 2015/1094 EN16825	clase climate 2015/1094 EN16825
UPR-27	-2°C +8°C	28°F 46°F	660 26	2145 84 7/16	845 33 1/4	3	645	230V-50Hz	R290	502	193	C 5 40°C 40%
UPR-55	-2°C +8°C	28°F 46°F	1350 56 1/16	2145 84 7/16	845 33 1/4	6+3	1404	230V-50Hz	R290	845	323	C 5 40°C 40%
UPR-82	-2°C +8°C	28°F 46°F	2035 80 1/8	2145 84 7/16	845 33 1/4	9+6	2197	230V-50Hz	R290	1702	816	D 5 40°C 40%
UPL-27	-20°C -15°C	-4°F +5°F	660 26	2145 84 7/16	845 33 1/4	3	645	230V-50Hz	R290	606	503	D 5 40°C 40%
UPL-55	-20°C -15°C	-4°F +5°F	1350 56 1/16	2145 84 7/16	845 33 1/4	6+3	1404	230V-50Hz	R290	907	870	E 4 30°C 55%
UPL-82	-20°C -15°C	-4°F +5°F	2035 80 1/8	2145 84 7/16	845 33 1/4	9+6	2197	230V-50Hz	R290	1814	1548	E 4 30°C 55%

Características técnicas y constructivas sujetas a variación sin previo aviso.

- Exterior en acero excepto el respaldo y fondo
- Interior en acero, con aristas curvas y fondo embutido
- Puertas de apertura reversible, con sistema de cierre automático y burlete magnético (permanece abierta al superar los 90° de apertura)
- Contrapuerta inox embutida
- Luz interior LED
- Estantes interiores de alambre en acero plastificado, regulables en altura
- Ruedas de serie
- Cuadro de mandos y rejilla ventilación motor, desmontables
- Unidad condensadora ventilada
- Evaporador sistema tiro forzado, con recubrimiento epoxi anticorrosión
- Paro ventiladores tiro forzado al abrir la puerta
- Evaporación automática del agua de descarche
- Aislamiento de poliuretano inyectado, densidad 40 Kg/m³, cero efectos ODP y GWP
- Control digital de temperatura, descarches optimizados, alarma por alta temperatura de condensación. Eficiente gestión del consumo de energía
- Temperatura de trabajo : 38°C

We reserve the right to change specifications without prior notice.

- Stainless steel exterior, except rear side and base
- Stainless steel interior, stamped bottom and rounded corners
- Doors with self closing system, blocked opening, magnetic gasket and possibility of changing the opening sense
- Inner side of doors by stamped steel
- LED lighting
- Shelves made of plasticized steel wire, height adjustable
- Castors as standard.
- Control panel and engine ventilation grill, removable
- Fan assisted condenser unit
- Fan assisted evaporator, with epoxi anticorrosion coating
- Evaporator fan stops when door is opened
- Automatic evaporation of defrost water
- 40 Kg/m³ density polyurethane insulation, zero ODP and GWP
- Digital temperature control, optimized defrost, high-temperature condensation alarm. Efficient management of energy consumption
- Operating temperature: : 38°C



OPCIONES	OPTIONS	€
parrilla adicional	additional grill	90 €
cerradura puerta inox superior	upper SS door lock	31 €
barras carniceras	meat bars	140 €
set 4 patas	set 4 legs	0 €
set 5 patas	set 5 legs	0 €
set 6 patas	set 6 legs	0 €
respaldo inox	SS rear side	consultar
tropicalizado 43°C	tropicalized 43 ° C	consultar
230V 60Hz / 115V 60Hz	230V 60Hz / 115V 60Hz	consultar
APCC	HACCP	consultar

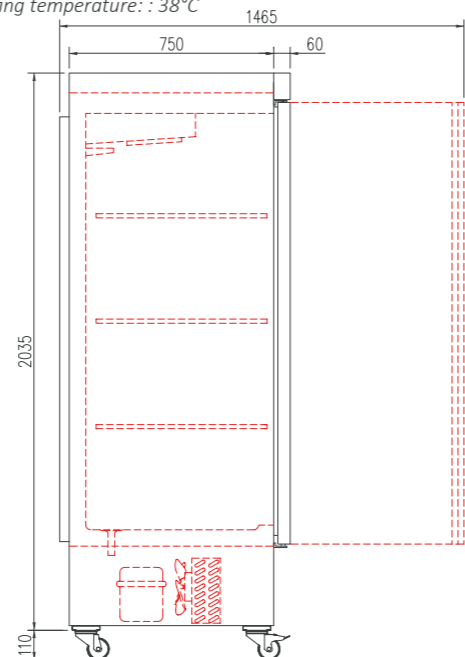

UPR-82



UPR-27



UPR-55



UPR-27G	2.936 €
UPL-27G	4.142 €

UPR-55G	4.445 €
UPL-55G	5.722 €

UPR-82G	6.047 €
UPL-82G	7.602 €

mod.	rango range	largo length (mm) (inch)	alto height (mm) (inch)	fondo depth (mm) (inch)	estantes shelves GN 2/1	volumen capacity (L)	voltaje voltage	refrigerante refrigerant	potencia frig. frig. power W	potencia power W	CCE EEC 2015/1094 EN16825	clase climate 2015/1094 EN16825
UPR-27G	-2°C +8°C	660 26	2145 84 7/16	845 33 1/4	4	645	230V-50Hz	R290	502	210	C	5 40°C 40%
UPR-55G	-2°C +8°C	1350 56 1/16	2145 84 7/16	845 33 1/4	8+4	1404	230V-50Hz	R290	845	510	D	4 30°C 55%
UPR-82G	-2°C +8°C	2035 80 1/8	2145 84 7/16	845 33 1/4	12+8	2197	230V-50Hz	R290	1702	936	D	4 30°C 55%
UPL-27G	-20°C -15°C	660 26	2145 84 7/16	845 33 1/4	4	645	230V-50Hz	R290	606	516	D	4 30°C 55%
UPL-55G	-20°C -15°C	1350 56 1/16	2145 84 7/16	845 33 1/4	8+4	1404	230V-50Hz	R290	907	896	E	4 30°C 55%
UPL-82G	-20°C -15°C	2035 80 1/8	2145 84 7/16	845 33 1/4	12+8	2197	230V-50Hz	R290	1814	1583	E	3 25°C 60%

Características técnicas y constructivas sujetas a variación sin previo aviso.

- Exterior en acero excepto el respaldo y fondo
- Interior en acero, con aristas curvas y fondo embutido
- Puertas de apertura reversible, con sistema de cierre automático y burlete magnético (permanece abierta al superar los 90° de apertura)
- Doble cristal
- Luz interior LED
- Estantes interiores de alambre en acero plastificado, regulables en altura
- Ruedas de serie (2 con freno + 2 sin freno)
- Cuadro de mandos y rejilla ventilación motor, desmontables
- Unidad condensadora ventilada
- Evaporador sistema tiro forzado, con recubrimiento epoxi anticorrosión
- Paro ventiladores tiro forzado al abrir la puerta
- Evaporación automática del agua de descarche
- Aislamiento de poliuretano inyectado, densidad 40 Kg/m³, cero efectos ODP y GWP
- Control digital de temperatura, descarches optimizados, alarma por alta temperatura de condensación. Eficiente gestión del consumo de energía
- Temperatura de trabajo : 32°C

We reserve the right to change specifications without prior notice

- Stainless steel exterior, except rear side and base
- Stainless steel interior, stamped bottom and rounded corners
- Doors with self closing system, blocked opening, magnetic gasket and possibility of changing the opening sense
- Double glazed door
- LED lighting
- Shelves made of plasticized steel wire, height adjustable
- Castors as standard (2 with brakes + 2 without)
- Control panel and engine ventilation grill, removable
- Fan assisted condenser unit
- Fan assisted evaporator, with epoxi anticorrosion coating
- Evaporator fan stops when door is opened
- Automatic evaporation of defrost water
- 40 Kg/m³ density polyurethane insulation, zero ODP and GWP
- Digital temperature control, optimized defrost, high-temperature condensation alarm. Efficient management of energy consumption
- Operating temperature: : 32°C

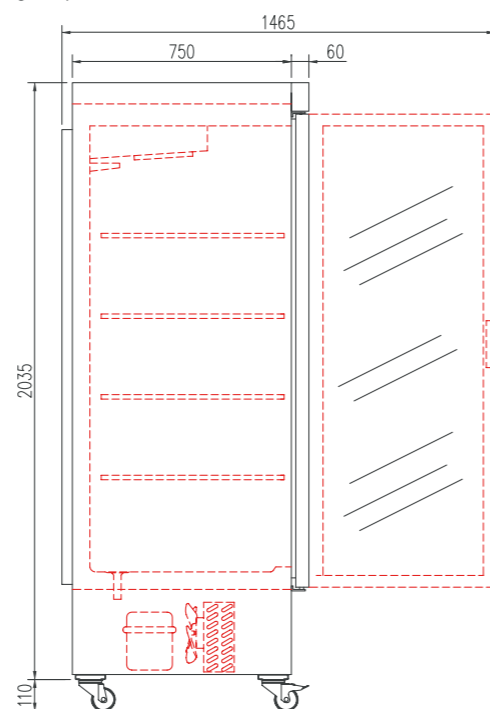

OPCIONES	OPTIONS	€
parrilla adicional	additional grill	90 €
cerradura puerta cristal	glass door lock	63 €
barras carniceras	meat bars	140 €
set 4 patas	set 4 legs	0 €
set 5 patas	set 5 legs	0 €
set 6 patas	set 6 legs	0 €
registrador de alarmas HACCP	HACCP alarm recorder	consultar
respaldo inox	SS rear side	consultar
tropicalizado 43°C	tropicalized 43 °C	consultar
230V 60Hz / 115V 60Hz	230V 60Hz / 115V 60Hz	consultar
APPCC	HACCP	consultar



UPR-82G



UPR-55G



UPR-27G