



# CORECO GOURMET



- Pag. 130-135 Cavas LUX  
*LUX wine cellars*
- Pag. 136-137 Armarios DAW  
*DAW displays*
- Pag. 142-147 Armarios AGW  
*AGW displays*
- Pag. 148-151 Expositores de vino  
*Wine displays*



- Pag. 154-157 Secadores de embutidos  
*Charcuterie*
- Pag. 158-159 Maduradores de carne DAW  
*DAW dry agers*
- Pag. 142-147 Maduradores de carne DA  
*DA dry agers*



- Pag. 164-167 Mesas trabajo refrigeradas 60x40  
*60x40 refrigerated counters*
- Pag. 168-171 Armarios 60x40 60x45  
*60x40 60x45 cabinets*
- Pag. 172-175 Armarios 60x80  
*60x80 cabinets*
- Pag. 176-177 Armarios helados  
*Ice-cream cabinets*
- Pag. 178-179 Armarios fermentación controlada  
*Retarder cabinets*
- Pag. 180-183 Armarios para carros  
*Roll-in cabinets*
- Pag. 185 TANQUE enfriador de agua  
*Water coolers*





VN23-2P	18.775 €	VNP23-2P	20.475 €	VN23-2P-PT	20.775 €	VNP23-2P-PT	22.475 €
VN26-2P	19.975 €	VNP26-2P	21.675 €	VN26-2P-PT	21.975 €	VNP26-2P-PT	23.675 €

mod.	rango range °C	largo length (mm)	alto height (mm)	fondo depth (mm)	estantes shelves	voltaje voltage	refrigerante refrigerant	potencia frig. frig. power W	potencia power W	clase 2015/1094 EN16825
VN23-2P	+5°C +18°C	1520	2300	640	opcional	230V-50Hz	R290	1168	917	4 30°C 55%
VNP23-2P	+5°C +18°C	1520	2300	640	opcional	230V-50Hz	R290	1168	917	4 30°C 55%
VN-23-2P-PT	+5°C +18°C	1520	2300	640	opcional	230V-50Hz	R290	1168	917	4 30°C 55%
VNP23-2P-PT	+5°C +18°C	1520	2300	640	opcional	230V-50Hz	R290	1168	917	4 30°C 55%
VN26-2P	+5°C +18°C	1520	2600	640	opcional	230V-50Hz	R290	1168	931	4 30°C 55%
VNP26-2P	+5°C +18°C	1520	2600	640	opcional	230V-50Hz	R290	1168	931	4 30°C 55%
VN-26-2P-PT	+5°C +18°C	1520	2600	640	opcional	230V-50Hz	R290	1168	931	4 30°C 55%
VNP26-2P-PT	+5°C +18°C	1520	2600	640	opcional	230V-50Hz	R290	1168	931	4 30°C 55%

- Dos alturas: 2600 mm y 2300 mm
- Capacidad de botellas variable en función de la dotación de estantes (opcional)
- Exterior en acero plastificado negro
- Interior en acero inoxidable
- Puertas de cristal doble sobre marco de aluminio perimetral y cerradura magnética
- Luz interior LED 3000K (perimetral)
- Unidad condensadora ventilada
- Evaporador y unidad condensadora sistema MONOBLOCK
- El sistema MONOBLOCK se suministra en un bulto aparte para colocar en la parte superior, acabado hermético
- Evaporación automática del agua de descarche
- Aislamiento de poliuretano inyectado, densidad 40 Kg/m<sup>3</sup>, cero ODP y GWP
- Control digital de última generación, monitorización en tiempo real, anticipación a incidencias, reducción de averías y simplificación del mantenimiento y uso por APP en smartphone o Tablet

- Two heights: 2600 mm and 2300 mm
- Variable bottle capacity depending on the number of shelves (optional)
- Black plastic-coated steel exterior
- Stainless steel interior
- Double-glazed glass doors on a perimeter aluminum frame and magnetic lock
- Perimetral 3000K LED interior lighting
- Ventilated condensing unit
- Monoblock evaporator and condensing unit system
- The MONOBLOCK system is supplied in a separate package for placement on top, with a hermetic finish.
- Automatic defrost water evaporation
- Injected polyurethane insulation, 40 kg/m<sup>3</sup> density, zero ODP and GWP
- Next-generation digital control, real-time monitoring, issue anticipation, reduced breakdowns, simplified maintenance, and APP-based operation via smartphone or tablet.

- VN:** costados y respaldo ciegos
- VNP:** costados panorámicos y respaldo ciego
- VN-PT:** costados y respaldo ciegos, puertas de cristal a dos caras
- VNP-PT:** costados panorámicos, puertas de cristal a dos caras

- VN:** Solid sides and back
- VNP:** Panoramic sides and solid back
- VN-PT:** Solid sides and back, double-sided glass doors
- VNP-PT:** Panoramic sides, double-sided glass doors

**SHELVES**  
We know how important the correct display of the product is and we adapt to your needs to achieve the best final effect.

**ESTANTES**  
Sabemos lo importante que es la correcta exposición del producto y nos adaptamos a sus necesidades para conseguir el mejor efecto final.



Botellas ø76x330  
ø76x330 bottles

	tipo de estante shelf design	capacidad botellas bottle capacity	niveles maximo por puerta max levels per door 2300	niveles maximo por puerta max levels per door 2600	PVP
1	acero horizontal horizontal SS	35 uds	4 uds	5 uds	195 € x ud
2	metacrilato inclinado inclined methacrylate	14 uds	5 uds	6 uds	220 € x ud
3	acero inclinado con frente madera roble SS with oak wood front	14 uds	5 uds	6 uds	220 € x ud
4	metacrilato horizontal horizontal methacrylate	10 uds	8 uds	9 uds	180 € x ud



VN26-2P-PT

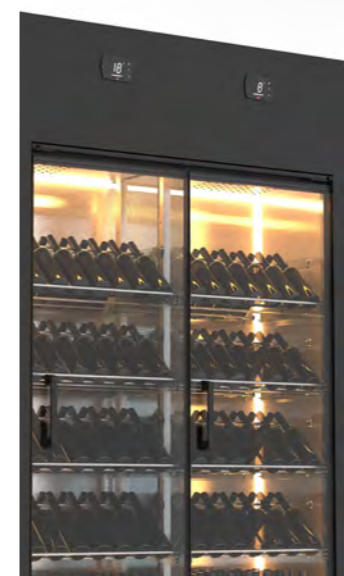

Opción Bi-Temperatura  
Separador metacrilato y controlador independiente

Dual-Temperature Option  
Methacrylate divider and independent controller

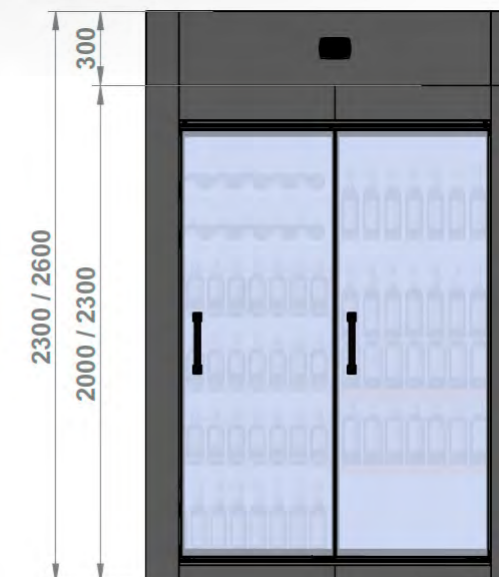



VN23-3P	26.285 €	VNP23-3P	28.665 €	VN23-3P-PT	29.085 €	VNP23-3P-PT	31.465 €
VN26-3P	27.965 €	VNP26-3P	30.345 €	VN26-3P-PT	30.765 €	VNP26-3P-PT	33.145 €

mod.	rango range °C	largo length (mm)	alto height (mm)	fondo depth (mm)	estantes shelves	voltaje voltage	refrigerante refrigerant	potencia frig. frig. power W	potencia power W	clase 2015/1094 EN16825
VN23-3P	+5°C +18°C	2140	2300	640	opcional	230V-50Hz	R290	1752	1337	4 30°C 55%
VNP23-3P	+5°C +18°C	2140	2300	640	opcional	230V-50Hz	R290	1752	1337	4 30°C 55%
VN-23-3P-PT	+5°C +18°C	2140	2300	640	opcional	230V-50Hz	R290	1752	1337	4 30°C 55%
VNP23-3P-PT	+5°C +18°C	2140	2300	640	opcional	230V-50Hz	R290	1752	1337	4 30°C 55%
VN26-3P	+5°C +18°C	2140	2600	640	opcional	230V-50Hz	R290	1752	1351	4 30°C 55%
VNP26-3P	+5°C +18°C	2140	2600	640	opcional	230V-50Hz	R290	1752	1351	4 30°C 55%
VN-26-3P-PT	+5°C +18°C	2140	2600	640	opcional	230V-50Hz	R290	1752	1351	4 30°C 55%
VNP26-3P-PT	+5°C +18°C	2140	2600	640	opcional	230V-50Hz	R290	1752	1351	4 30°C 55%

- Dos alturas: 2600 mm y 2300 mm
- Capacidad de botellas variable en función de la dotación de estantes (opcional)
- Exterior en acero plastificado negro
- Interior en acero inoxidable
- Puertas de cristal doble sobre marco de aluminio perimetral y cerradura magnética
- Luz interior LED 3000K (perimetral)
- Unidad condensadora ventilada
- Evaporador y unidad condensadora sistema MONO- Evaporación automática del agua de descarche
- Aislamiento de poliuretano inyectado, densidad 40 Kg/m<sup>3</sup>, cero ODP y GWP
- Control digital de última generación, monitorización en tiempo real, anticipación a incidencias, reducción de averías y simplificación del mantenimiento y uso por APP en smartphone o Tablet

- Two heights: 2600 mm and 2300 mm
- Variable bottle capacity depending on the number of shelves (optional)
- Black plastic-coated steel exterior
- Stainless steel interior
- Double-glazed glass doors on a perimeter aluminum frame and magnetic lock
- Perimetral 3000K LED interior lighting
- Ventilated condensing unit
- Monoblock evaporator and condensing unit system
- The MONOBLOCK system is supplied in a separate package for placement on top, with a hermetic finish.
- Automatic defrost water evaporation
- Injected polyurethane insulation, 40 kg/m<sup>3</sup> density, zero ODP and GWP
- Next-generation digital control, real-time monitoring, issue anticipation, reduced breakdowns, simplified maintenance, and APP-based operation via smartphone or tablet.

VN: costados y respaldo ciegos

VNP: costados panorámicos y respaldo ciego

VN-PT: costados y respaldo ciegos, puertas de cristal a dos caras

VNP-PT: costados panorámicos, puertas de cristal a dos caras

**ESTANTES**

Sabemos lo importante que es la correcta exposición del producto y nos adaptamos a sus necesidades para conseguir el mejor efecto final.

**SHELVES**

We know how important the correct display of the product is and we adapt to your needs to achieve the best final effect.



Botellas ø76x330  
ø76x330 bottles

	tipo de estante shelf design	capacidad botellas bottle capacity	niveles maximo por puerta max levels per door 2300	niveles maximo por puerta max levels per door 2600	PVP
1	acero horizontal horizontal SS	35 uds	4 uds	5 uds	195 € x ud
2	metacrilato inclinado inclined methacrylate	14 uds	5 uds	6 uds	220 € x ud
3	acero inclinado con frente madera roble SS with oak wood front	14 uds	5 uds	6 uds	220 € x ud
4	metacrilato horizontal horizontal methacrylate	10 uds	8 uds	9 uds	180 € x ud



VN26-2P-PT

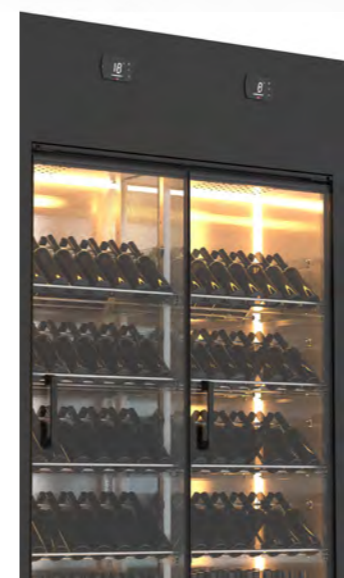

Opción Bi-Temperatura  
Separador metacrilato y controlador independiente

Dual-Temperature Option  
Methacrylate divider and independent controller

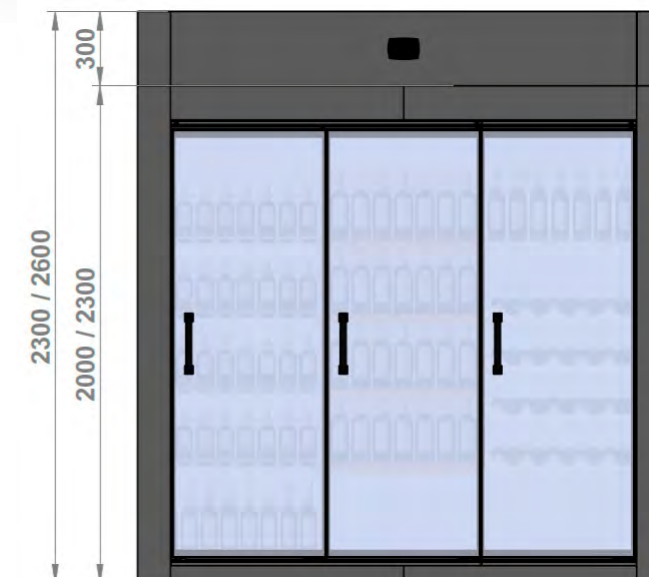





DAW-200-NN	1.571 €
DAW-200-NI	

DAW-400-NN	2.254 €
DAW-400-NI	

mod.	rango range °C	largo length (mm)	alto height (mm)	fondo depth (mm)	estantes shelves	volumen capacity (L)	capacidad botellas bottles capacity (uds)	voltaje voltage	refrigerante refrigerant	potencia frig. frig. power W	potencia power W	clase 2015/1094 EN16825
DAW-200	+2°C +18°C	600	900	650	2	120	26	230V-50Hz	R290	304	201	4 30°C 55%
DAW-400	+2°C +18°C	600	1545	650	4	240	60	230V-50Hz	R290	460	241	4 30°C 55%

Características técnicas y constructivas sujetas a variación sin previo aviso.

- Exterior en acero plastificado negro (lacado opcional), excepto el respaldo
- **NI**: Interior en acero inox AISI-304
- **NN**: Interior en acero plastificado negro
- Puerta de apertura reversible, con sistema de cierre automático y burlete magnético (permanece abierta al superar los 90° de apertura), con marco aluminio anodizado y doble cristal con tratamiento bajoemisor (reduce la condensación de humedad)
- Cerradura de serie
- Doble luz interior LED 3000K
- Estantes en AISI-304 con frontal en madera, inclinables 20°
- Unidad condensadora ventilada
- Evaporador sistema tiro forzado, con recubrimiento epoxi anticorrosión
- Paro ventiladores tiro forzado al abrir la puerta
- Evaporación automática del agua de descarche
- Aislamiento de poliuretano inyectado, densidad 40 Kg/m<sup>3</sup>, cero ODP y GWP
- Control digital de temperatura, con eficiente gestión del consumo de energía

**EBRW-1302/2**: dos departamentos independientes, con regulación de temperatura en rango +2°C +18°C

We reserve the right to change specifications without prior notice.

- Black coated steel (laquered on demand) exterior, except rear side.
- **NI**: AISI-304 Stainless steel interior
- **NN**: black plastic coated interior
- Reversible opening door, with automatic closing system and magnetic weatherstripping (remains open when opening over 90°), with anodized aluminum frame and triple glass with low-emission treatment (reduces moisture condensation)
- Lock as standard
- Double LED interior light, 3000K
- AISI-304 shelves with front part on wood, can be mounted at a 20° angle
- Ventilated condensing unit
- Evaporator forced draft system, with anti-corrosion epoxy coating
- Forced draft fans stop when the door is opened
- Automatic evaporation of defrost water
- Injected polyurethane insulation, density 40 Kg / m<sup>3</sup>, zero ODP and GWP
- Digital temperature control, efficient management of energy consumption

**EBRW-1302/2** two independent departments, with +2°C +18°C suitable temperature

OPCIONES	OPTIONS	€
estante adicional	additional shelf	133 €
estante especial	customized shelf	consultar
set 4 ruedas	4 castors set	112 €
set 4 patas	4 legs set	62 €
exterior inox o lacado	SS exterior or laquered	consultar
230v 60Hz / 115v 60Hz	230v 60Hz / 115v 60Hz	consultar

#### ESTANTES

Sabemos lo importante que es la correcta exposición del producto y nos adaptamos a sus necesidades para conseguir el mejor efecto final.

#### SHELVES

We know how important the correct display of the product is and we adapt to your needs to achieve the best final effect.

Estantes estándar (inclinables 20°) - Standard shelves (tiltable 20°)



Estantes especiales (inclinación 35°)  
Customized shelves (35° inclination)



+18°C  
+5°C



#### DAW-200-NI

Interior INOX, estante especial SS interior, customized shelf



#### DAW-400-NN

Interior NEGRO, estante adicional BLACK interior, additional shelf



#### DA-200

Interior y exterior inox opcional  
SS interior and exterior, optional

#### DAW-200



EBRW-751-NN  
EBRW-751-NI 2.890 €EBRW-1302-NN  
EBRW-1302-NI 4.335 €  
EBRW-1302/2-NN  
EBRW-1302/2-NI 5.238 €EBRW-2003-NN  
EBRW-2003-NI 5.493 €  
EBRW-2003/2-NN  
EBRW-2003/2-NI 6.297 €

mod.	rango range °C	largo length (mm)	alto height (mm)	fondo depth (mm)	estantes shelves	volumen capacity (L)	capacidad botellas bottles capacity (uds)	voltaje voltage	refrigerante refrigerant	potencia frig. frig. power W	potencia power W	clase 2015/1094 EN16825
EBRW-751	+2°C +18°C	680	2055	735	6	505	105	230V-50Hz	R290	502	260	4 30°C 55%
EBRW-1302	+2°C +18°C	1370	2055	735	12	1201	210	230V-50Hz	R290	845	396	4 30°C 55%
EBRW-1302/2	+2°C +18°C	1370	2055	735	12	505 + 505	105 + 105	230V-50Hz	R290	502 + 502	260 + 260	4 30°C 55%
EBRW-2003	+2°C +18°C	2055	2055	735	18	1852	315	230V-50Hz	R290	1814	1726	4 30°C 55%
EBRW-2003/2	+2°C +18°C	2055	2055	735	18	1201 + 505	210 + 105	230V-50Hz	R290	845 + 502	396 + 260	4 30°C 55%

Características técnicas y constructivas sujetas a variación sin previo aviso.

- Exterior en acero plastificado negro (lacado opcional), excepto el respaldo
- **NI:** Interior en acero inox AISI-304
- **NN:** Interior en acero plastificado negro
- Puertas de apertura reversible (751), con sistema de cierre automático y burlete magnético (permanece abierta al superar los 90° de apertura), con marco aluminio anodizado y doble cristal con tratamiento bajoemisorio (reduce la condensación de humedad)
- Cerradura de serie
- Doble luz interior LED 3000K
- Estantes en AISI-304 con frontal en madera, inclinables 20°
- Unidad condensadora ventilada
- Evaporador sistema tiro forzado, con recubrimiento epoxi anticorrosión
- Paro ventiladores tiro forzado al abrir la puerta
- Evaporación automática del agua de descarche
- Aislamiento de poliuretano inyectado, densidad 40 Kg/m<sup>3</sup>, cero ODP y GWP
- Control digital de temperatura, con eficiente gestión del consumo de energía

**EBRW-1302/2 y 2003/2:** dos departamentos independientes, con regulación de temperatura en rango +2°C +18°C

OPCIONES	OPTIONS	€
estante adicional	additional shelf	133 €
estante especial	customized shelf	consultar
set 4 ruedas	set 4 wheels	111 €
set 6 ruedas	set 6 wheels	165 €
set 4 patas	set 4 legs	62 €
set 6 patas	set 6 legs	98 €
exterior inox o lacado	SS exterior or laquered	consultar
230v 60Hz / 115v 60Hz	230v 60Hz / 115v 60Hz	consultar

We reserve the right to change specifications without prior notice.

- Black coated steel (laquered on demand) exterior, except rear side.
- **NI:** AISI-304 Stainless steel interior
- **NN:** black plastic coated interior
- Reversible opening doors (751), with automatic closing system and magnetic weatherstripping (remains open when opening over 90°), with anodized aluminum frame and triple glass with low-emission treatment (reduces moisture condensation)
- Lock as standard
- Double LED interior light, 3000K
- AISI-304 shelves with front part on wood, can be mounted at a 20° angle
- Ventilated condensing unit
- Evaporator forced draft system, with anti-corrosion epoxy coating
- Forced draft fans stop when the door is opened
- Automatic evaporation of defrost water
- Injected polyurethane insulation, density 40 Kg / m<sup>3</sup>, zero ODP and GWP
- Digital temperature control, efficient management of energy consumption

**EBRW-1302/2 and 2003/2:** two independent departments, with +2°C +18°C suitable temperature

#### ESTANTES

Sabemos lo importante que es la correcta exposición del producto y nos adaptamos a sus necesidades para conseguir el mejor efecto final.

#### SHELVES

We know how important the correct display of the product is and we adapt to your needs to achieve the best final effect.

Estantes estándar (inclinables 20°) - Standard shelves (tiltable 20°)



Estantes especiales (inclinación 35°)  
Customized shelves (35° inclination)



EBRW-751-NN

+18°C  
+5°C

EBRW-1302/2-NI bi-temperatura  
Interior INOX  
SS interior



AGW-751-NN	2.996 €
AGW-751-NI	

AGW-1002-NN	4.528 €
AGW-1002-NI	
AGW-1002/2-NN	5.508 €
AGW-1002/2-NI	

mod.	rango range °C	largo length (mm)	alto height (mm)	fondo depth (mm)	estantes shelves	volumen capacity (L)	capacidad botellas bottles capacity (uds)	voltaje voltage	refrigerante refrigerant	potencia frig. frig. power W	potencia power W	clase 2015/1094 EN16825
AGW-751	+2°C +18°C	680	2130	860	6	625	105	230V-50Hz	R290	502	263	4 30°C 55%
AGW-1002	+2°C +18°C	1370	2130	860	12	1404	210	230V-50Hz	R290	845	396	4 30°C 55%
AGW-1002/2	+2°C +18°C	1370	2130	860	12	625 + 625	105 + 105	230V-50Hz	R290	502 + 502	263 + 263	4 30°C 55%

Características técnicas y constructivas sujetas a variación sin previo aviso.

- Exterior en acero plastificado negro (lacado opcional), excepto el respaldo
- **NI**: Interior en acero inox AISI-304
- **NN**: Interior en acero plastificado negro
- Puertas de apertura reversible (751), con sistema de cierre automático y burlete magnético (permanece abierta al superar los 90° de apertura), con marco aluminio anodizado y doble cristal con tratamiento bajoemisorio (reduce la condensación de humedad)
- Cerradura de serie
- Doble luz interior LED 3000K
- Estantes en AISI-304 con frontal en madera, inclinables 20°
- Unidad condensadora ventilada
- Evaporador sistema tiro forzado, con recubrimiento epoxi anticorrosión
- Paro ventiladores tiro forzado al abrir la puerta
- Evaporación automática del agua de descarche
- Aislamiento de poliuretano inyectado, densidad 40 Kg/m<sup>3</sup>, cero ODP y GWP
- Control digital de última generación, monitorización en tiempo real, anticipación a incidencias, reducción de averías y simplificación del mantenimiento y uso por APP en smartphone o Tablet
- **AGW-1002/2**: dos departamentos independientes, con regulación de temperatura en rango +2°C +18°C

We reserve the right to change specifications without prior notice.

- Black coated steel (laquered on demand) exterior, except rear side.
- **NI**: AISI-304 Stainless steel interior
- **NN**: black plastic coated interior
- Reversible opening doors (751), with automatic closing system and magnetic weatherstripping (remains open when opening over 90°), with anodized aluminum frame and triple glass with low-emission treatment (reduces moisture condensation)
- Lock as standard
- Double LED interior light, 3000K
- AISI-304 shelves with front part on wood, can be mounted at a 20° angle
- Ventilated condensing unit
- Evaporator forced draft system, with anti-corrosion epoxy coating
- Forced draft fans stop when the door is opened
- Automatic evaporation of defrost water
- Injected polyurethane insulation, density 40 Kg / m<sup>3</sup>, zero ODP and GWP
- Next-generation digital control, real-time monitoring, issue anticipation, reduced breakdowns, simplified maintenance, and APP-based operation via smartphone or tablet.
- **AGW-1002/2**: two independent departments, with +2°C +18°C suitable temperature

OPCIONES	OPTIONS	€
estante adicional	additional shelf	133 €
estante especial	customized shelf	consultar
set 4 ruedas	set 4 wheels	111 €
set 6 ruedas	set 6 wheels	165 €
set 4 reguladores	set 4 knobs	62 €
set 6 reguladores	set 6 knobs	98 €
exterior inox o lacado	SS exterior or laquered	consultar
230v 60Hz / 115v 60Hz	230v 60Hz / 115v 60Hz	consultar

#### ESTANTES

Sabemos lo importante que es la correcta exposición del producto y nos adaptamos a sus necesidades para conseguir el mejor efecto final.

#### SHELVES

We know how important the correct display of the product is and we adapt to your needs to achieve the best final effect.

Estantes estándar (inclinables 20°) - Standard shelves (tiltable 20°)



Estantes especiales (inclinación 35°)  
Customized shelves (35° inclination)



+18°C  
+5°C



AGW-1002-NI



DA-1002-NI

AGW-1002-NI



AGWP-751-NN	3.976 €
AGWP-751-NI	

AGWP-1002-NN	5.508 €
AGWP-1002-NI	
AGWP-1002/2-NN	6.488 €
AGWP-1002/2-NI	

mod.	rango range °C	largo length (mm)	alto height (mm)	fondo depth (mm)	estantes shelves	volumen capacity (L)	capacidad botellas bottles capacity (uds)	voltaje voltage	refrigerante refrigerant	potencia frig. frig. power W	potencia power W	clase 2015/1094 EN16825
AGWP-751	+2°C +18°C	680	2130	860	6	625	105	230V-50Hz	R290	502	263	4 30°C 55%
AGWP-1002	+2°C +18°C	1370	2130	860	12	1404	210	230V-50Hz	R290	845	396	4 30°C 55%
AGWP-1002/2	+2°C +18°C	1370	2130	860	12	625 + 625	105 + 105	230V-50Hz	R290	502 + 502	263 + 263	4 30°C 55%

Características técnicas y constructivas sujetas a variación sin previo aviso.

- Exterior en acero plastificado negro (lacado opcional), excepto el respaldo
- **NI**: Interior en acero inox AISI-304
- **NN**: Interior en acero plastificado negro
- Costados con triple acristalamiento y tratamiento bajoemisor (reduce la condensación de humedad)
- Puertas de apertura reversible (751), con sistema de cierre automático y burlete magnético (permanece abierta al superar los 90° de apertura), con marco aluminio anodizado y doble cristal con tratamiento bajoemisor (reduce la condensación de humedad)
- Cerradura de serie
- Doble luz interior LED 3000K
- Estantes en AISI-304 con frontal en madera, inclinables 20°
- Unidad condensadora ventilada
- Evaporador sistema tiro forzado, con recubrimiento epoxi anticorrosión
- Paro ventiladores tiro forzado al abrir la puerta
- Evaporación automática del agua de descarche
- Aislamiento de poliuretano inyectado, densidad 40 Kg/m<sup>3</sup>, cero ODP y GWP
- Control digital de última generación, monitorización en tiempo real, anticipación a incidencias, reducción de averías y simplificación del mantenimiento y uso por APP en smartphone o Tablet
- **AGWP-1002/2**: dos departamentos independientes, con regulación de temperatura en rango +2°C +18°C

We reserve the right to change specifications without prior notice.

- Black coated steel (laquered on demand) exterior, except rear side.
- **NI**: AISI-304 Stainless steel interior
- **NN**: black plastic coated interior
- Triple glazed sides with low-emission treatment (reduces moisture condensation)
- Reversible opening doors (751), with automatic closing system and magnetic weatherstripping (remains open when opening over 90°), with anodized aluminum frame and triple glass with low-emission treatment (reduces moisture condensation)
- Lock as standard
- Double LED interior light, 3000K
- AISI-304 shelves with front part on wood, can be mounted at a 20° angle
- Ventilated condensing unit
- Evaporator forced draft system, with anti-corrosion epoxy coating
- Forced draft fans stop when the door is opened
- Automatic evaporation of defrost water
- Injected polyurethane insulation, density 40 Kg / m<sup>3</sup>, zero ODP and GWP
- Next-generation digital control, real-time monitoring, issue anticipation, reduced breakdowns, simplified maintenance, and APP-based operation via smartphone or tablet.
- **AGWP-1002/2**: two independent departments, with +2°C +18°C suitable temperature

OPCIONES	OPTIONS	€
estante adicional	additional shelf	133 €
estante especial	customized shelf	consultar
set 4 ruedas	set 4 wheels	111 €
set 6 ruedas	set 6 wheels	165 €
set 4 reguladores	set 4 knobs	62 €
set 6 reguladores	set 6 knobs	98 €
exterior inox o lacado	SS exterior or laquered	consultar
230v 60Hz / 115v 60Hz	230v 60Hz / 115v 60Hz	consultar

#### ESTANTES

Sabemos lo importante que es la correcta exposición del producto y nos adaptamos a sus necesidades para conseguir el mejor efecto final.

#### SHELVES

We know how important the correct display of the product is and we adapt to your needs to achieve the best final effect.

Estantes estándar (inclinables 20°) - Standard shelves (tiltable 20°)



Estantes especiales (inclinación 35°)  
Customized shelves (35° inclination)



+18°C  
+5°C



AGWP-1002-NI



DA-1002-NI

AGW-1002-NI



AGW-751-PT	3.976 €	AGWP-751-PT	4.285 €	AGW-1002-PT	6.110 €	AGWP-1002-PT	6.665 €
				AGW-1002/2-PT	7.680 €	AGWP-1002/2-PT	8.235 €

mod.	rango range °C	largo length (mm)	alto height (mm)	fondo depth (mm)	estantes shelves	volumen capacity (L)	capacidad botellas bottles capacity (uds)	voltaje voltage	refrigerante refrigerant	potencia frig. frig. power W	potencia power W	clase 2015/1094 EN16825
AGWP-751-PT	+4°C +18°C	680	2130	865	5	565	60	230V-50Hz	R290	584	446	4 30°C 55%
AGWP-1002-PT	+4°C +18°C	1370	2130	865	10	1285	120	230V-50Hz	R290	584	473	4 30°C 55%

Características técnicas y constructivas sujetas a variación sin previo aviso.

- Exterior en acero plastificado negro (lacado opcional), excepto el respaldo
- **PT:** Costados con triple acristalamiento y tratamiento bajoemisor (reduce la condensación de humedad)
- Puertas de apertura reversible (751), con sistema de cierre automático y burlete magnético (permanece abierta al superar los 90° de apertura), con marco aluminio anodizado y doble cristal con tratamiento bajoemisor (reduce la condensación de humedad)
- Cerradura de serie
- Doble luz interior LED 3000K
- Estantes en AISI-304 con frontal en madera, inclinados
- Unidad condensadora ventilada
- Evaporador sistema tiro forzado, con recubrimiento epoxi anticorrosión
- Paro ventiladores tiro forzado al abrir la puerta
- Evaporación automática del agua de descharche
- Aislamiento de poliuretano inyectado, densidad 40 Kg/m<sup>3</sup>, cero ODP y GWP
- Control digital de última generación, monitorización en tiempo real, anticipación a incidencias, reducción de averías y simplificación del mantenimiento y uso por APP en smartphone o Tablet

We reserve the right to change specifications without prior notice.

- Black coated steel (laquered on demand) exterior, except rear side.
- **PT:** Triple glazed sides with low-emission treatment (reduces moisture condensation)
- Reversible opening doors (751), with automatic closing system and magnetic weatherstripping (remains open when opening over 90°), with anodized aluminum frame and triple glass with low-emission treatment (reduces moisture condensation)
- Lock as standard
- Double LED interior light, 3000K
- AISI-304 shelves with front part on wood, inclined
- Ventilated condensing unit
- Evaporator forced draft system, with anti-corrosion epoxy coating
- Forced draft fans stop when the door is opened
- Automatic evaporation of defrost water
- Injected polyurethane insulation, density 40 Kg / m<sup>3</sup>, zero ODP and GWP
- Next-generation digital control, real-time monitoring, issue anticipation, reduced breakdowns, simplified maintenance, and APP-based operation via smartphone or tablet.

OPCIONES	OPTIONS	€
estante adicional	additional shelf	133 €
estante especial	customized shelf	consultar
set 4 ruedas	set 4 wheels	111 €
set 6 ruedas	set 6 wheels	165 €
set 4 patas	set 4 legs	62 €
set 6 patas	set 6 legs	98 €
exterior inox o lacado	SS exterior or laquered	consultar
230v 60Hz / 115v 60Hz	230v 60Hz / 115v 60Hz	consultar

#### ESTANTES

Sabemos lo importante que es la correcta exposición del producto y nos adaptamos a sus necesidades para conseguir el mejor efecto final.

#### SHELVES

We know how important the correct display of the product is and we adapt to your needs to achieve the best final effect.

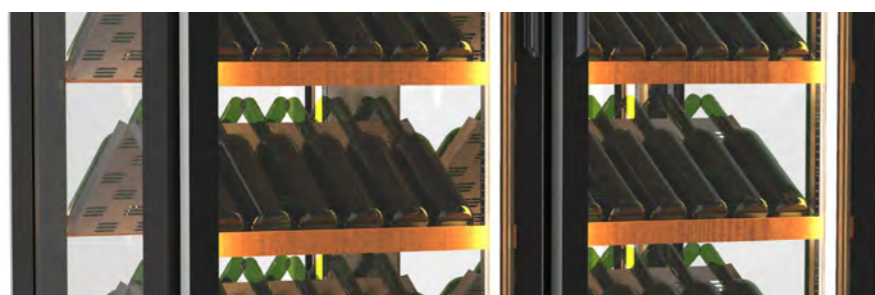

+18°C  
+5°C



AGWP-1002-PT



AGW-751-PT



ERHW-150-L 1.245 €   ERHW-250-L 1.617 €   ERHW-350-L 1.694 €   ERHWS-250-L 1.996 €   ERHWS-350-L 2.152 €

mod.	rango range °C	largo length (mm)	alto height (mm)	puertas abatibles hinged doors	puertas correderas sliding doors	estantes shelves	capacidad latas cans capacity (33 cl.)	voltaje voltage	refrigerante refrigerant	potencia frig. frig. power W	potencia power W
ERH-W150-L	+2°C +8°C	620	850	1	0	2	150	230V-50Hz	R290	255	200
ERHW-250-L	+2°C +8°C	925	850	2	0	2	225	230V-50Hz	R290	502	331
ERHW-350-L	+2°C +8°C	1375	850	3	0	2	320	230V-50Hz	R290	502	375
ERHWS-250-L	+2°C +8°C	925	850	0	2	2	225	230V-50Hz	R290	502	331
ERHWS-350-L	+2°C +8°C	1375	850	0	2	2	320	230V-50Hz	R290	502	375

Características técnicas y constructivas sujetas a variación sin previo aviso.

#### ERHW

- Exterior en acero plastificado negro
- Interior en acero plastificado gris
- Doble cristal sobre marco abatible, con cerradura de serie

#### ERHWS

- Exterior en acero plastificado negro
- Interior en acero plastificado gris
- Doble cristal sobre marco deslizante, con cerradura opcional

#### CARACTERÍSTICAS COMUNES

- Diseñados para botellas de vino
- Estantes de alambre de acero plastificado, regulables en altura
- Compresor hermético alto par de arranque
- Evaporador sistema tiro forzado, con recubrimiento epoxi anticorrosión
- Control digital de temperatura, descarches optimizados, alarma por alta temperatura de condensación. Eficiente gestión del consumo de energía
- Unidad condensadora ventilada libre de mantenimiento
- Aislamiento de poliuretano inyectado, densidad 40 Kg/m<sup>3</sup>, bajo GWP y cero efecto ODP
- Evaporación automática del agua de descarche
- Temperatura de trabajo +4°C +18°C a 32°C ambiente
- Tensión monofásica 230V - 50 Hz



OPCIONES	OPTIONS	€
estante chapa perforada 150	perforated sheet metal shelf 150	82 €
estante chapa perforada 250	perforated sheet metal shelf 250	96 €
estante chapa perforada 350	perforated sheet metal shelf 350	108 €
230V 60Hz / 115V 60Hz	230V 60Hz / 115V 60Hz	consultar
ruedas	castors	consultar
cerradura ERHWS	ERHWS lock	65 €

We reserve the right to change specifications without prior notice.

#### ERHW

- Black plastic coated steel exterior
- Interior gray plastic coated steel
- Double glass on folding frame with lock as standard

#### ERHWS

- Black plastic coated steel exterior
- Interior gray plastic coated steel
- Double glass on sliding frame with optional lock

#### FEATURES IN COMMON

- Designed for bottled wine
- Steel wire shelves adjustable plastic height
- Hermetic compressor higher starting torque
- Forced draft evaporator system with anticorrosion coating
- Digital temperature control, optimized defrost, high-temperature condensation alarm. Efficient management of energy consumption
- Ventilated condensing unit (free condenser maintenance)
- Isolation of polyurethane, density 40 Kg / m<sup>3</sup>, zero ODP and GWP
- Automatic evaporation of defrost water
- Operating temperature +4°C +18° 32°C ambient
- Voltage 230V - 50 Hz

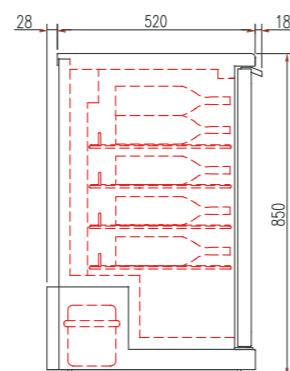

ECW-620 2.123 €

mod.	rango range °C	largo length (mm)	alto height (mm)	fondo depth (mm)	estantes shelves	capacidad capacidad (L)	capacidad botellas. bottles capacity (Uds)	voltaje voltage	refrigerante refrigerant	potencia frig. frig. power W	potencia power W
CEVRW-620	+4 +18°C	620	1885	578	5	236	85	230V-50Hz	R600a	236	189

Características técnicas y constructivas sujetas a variación sin previo aviso.

- Exterior e interior en acero plastificado negro
- Puertas batientes sin marco y frontal completo de cristal con serigrafía mínima negro RAL 9005 con sistema de cierre automático y burlete magnético (permanece abierta al superar los 90° de apertura)
- Sistema anti-vibración
- Bajo nivel sonoro
- 5 niveles de estantes con frontal de madera de pino maciza
- Estante para botella vertical opcional al mismo precio
- Led vertical interior en 3000K continuo, que mejora la visibilidad de las botellas
- Refrigeración ventilada
- Bandeja de evaporación automática
- Control digital de temperatura, incorpora alarma de alta temperatura
- Dos rangos de temperatura disponibles: Vino Tinto (+10°C +18°C) o Vino Blanco, Rosado y Brut (+4°C +8°C)
- Clase climática 4 (30°C 55% HR)

We reserve the right to change specifications without prior notice.

- Exterior and Interior in black plastic-coated steel
- Frameless swing doors and full glass front with minimal black RAL 9005 screen printing with automatic closing system and magnetic gasket (remains open when opening more than 90°)
- Anti-vibration system
- Low sound level
- 5 levels of shelves with solid pine wood front
- Optional vertical bottle rack at the same price
- Interior vertical LED in 3000K continuous, which improves the visibility of the bottles
- Ventilated cooling
- Automatic evaporation tray
- Digital temperature control, incorporates high temperature alarm
- Two temperature ranges available: Red Wine (+10°C +18°C) or White, Rosé and Brut Wine (+4°C +8°C)
- Climate class 4 (30°C 55% RH)

mod.	ext. toal lacado Total lacquered exterior	estante adicional extra shelf (ud)	ruedas castors (kit)
CEVRW-620	consultar - consult	130 € x ud	98 €

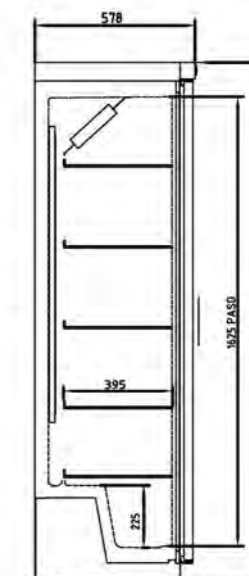



CEVRW-440	2.183 €	CEVRW-750	2.920 €	CARMW-125	5.839 €	CAGMW-125	5.839 €
		CARW-125	5.304 €				

mod.	rango range °C	largo length (mm)	alto height (mm)	fondo depth (mm)	estantes evaporadores evap. shelves	capacidad capacity (L)	capacidad capacity (uds)	voltaje voltage	refrigerante refrigerant	potencia frig. frig. power W	potencia power W
CEVRW-440	+4 +18°C	430	1815	510	5	200	48	230V-50Hz	R290	205	168
CEVRW-750	+4 +18°C	750	1815	510	5	385	105	230V-50Hz	R290	205	188
CARW-125	+4 +18°C	1250	1935	770	5	1000	225	230V-50Hz	R290	543	434
CARMW-125	+4 +18°C	1250	1935	770	10	1000	210	230V-50Hz	R290	271+271	213+213
CAGMW-125	+4 +18°C	1250	1935	770	10	1000	195	230V-50Hz	R290	271+272	213+213

Características técnicas y constructivas sujetas a variación sin previo aviso.

We reserve the right to change specifications without prior notice.

- Exterior e interior en acero plastificado negro (exterior madera opcional)
- Ideales para botella de vino horizontal / vertical ajustando dicho estante, gran capacidad de almacenamiento
- Puertas batientes sin marco y frontal completo de cristal con serigrafía mínima negro RAL 9005 con sistema de cierre automático y burlete magnético (permanece abierta al superar los 90° de apertura)
- Sistema antivibración
- Bajo nivel sonoro
- 5 niveles de estantes con frontal de madera de pino maciza
- Led vertical interior en 3000K continuo, que mejora la visibilidad de las botellas
- Refrigeración ventilada
- Bandeja de evaporación automática
- Control digital de temperatura, incorpora alarma de alta temperatura
- Dos rangos de temperatura disponibles: Vino Tinto (+10°C +18°C) o Vino Blanco, Rosado y Brut (+4°C +8°C)
- Clase climática 4 (30°C 55% HR)
- CARMW-125 y CAGMW, departamentos independientes

- Exterior and interior in black plastic-coated steel (exterior wood optional)
- Ideal for horizontal / vertical wine bottle by adjusting said shelf, large storage capacity
- Frameless swing doors and full glass front with minimal black RAL 9005 screen printing with automatic closing system and magnetic gasket (remains open when opening more than 90°)
- Anti-vibration system
- Low sound level
- 5 levels of shelves with solid pine wood front
- Interior vertical LED in 3000K continuous, which improves the visibility of the bottles
- Ventilated cooling
- Automatic evaporation tray
- Digital temperature control, incorporates high temperature alarm
- Two temperature ranges available: Red Wine (+10°C +18°C) or White, Rosé and Brut Wine (+4°C +8°C)
- Climate class 4 (30°C 55% RH)
- CARMW-125 and CAGMW, independent sections

mod.	ext. toal lacado Total lacquered exterior	estante adicional extra shelf (ud)	ruedas castors (kit)
CEVRW-440	consultar - consult	137 € x ud	114 €
CEVRW-750	consultar - consult	137 € x ud	114 €
CARW-125	consultar - consult	137 € x ud	-
CARMW-125	consultar - consult	137 € x ud	-
CAGMW-125	consultar - consult	137 € x ud	-

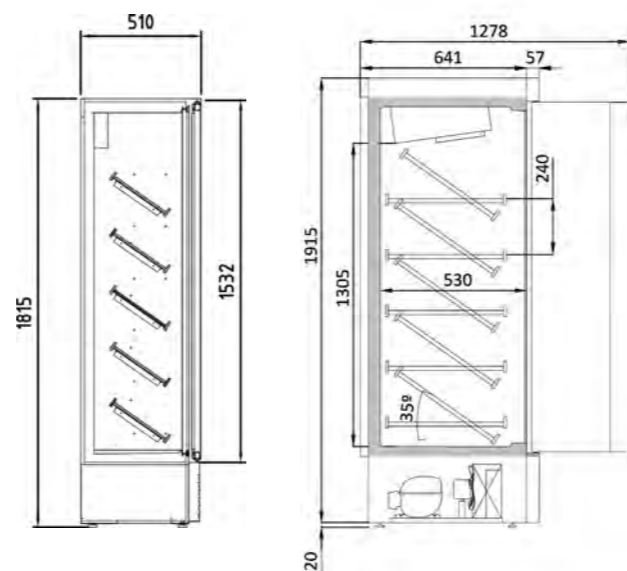

Detalle estante inclinado  
Inclined shelf detail



CEFIW-1R	3.923 €	CEFIW-2R	5.246 €	CEFIW-3R	6.788 €
----------	---------	----------	---------	----------	---------

mod.	rango range °C	largo length (mm)	alto height (mm)	fondo depth (mm)	estantes evaporadores evap. shelves	capacidad capacity (L)	capacidad capacity (uds)	voltaje voltage	refrigerante refrigerant	potencia frig. frig. power W	potencia power W
CEFIW-1R	+4 +18°C	642	2131	805	3	461	90	230V-50Hz	R290	555	1132
CEFIW-2R	+4 +18°C	1285	2131	805	3	1010	210	230V-50Hz	R290	1192	1508
CEFIW-3R	+4 +18°C	1925	2131	805	6	1570	300	230V-50Hz	R290	1528	1945

Características técnicas y constructivas sujetas a variación sin previo aviso.

We reserve the right to change specifications without prior notice.

- Exterior e interior en acero plastificado negro (exterior madera opcional)
- Ideales para botella de vino horizontal / vertical ajustando dicho estante, gran capacidad de almacenamiento
- Puertas batientes sin marco y frontal completo de cristal con serigrafía mínima negro RAL 9005 con sistema de cierre automático y burlete magnético (permanece abierta al superar los 90° de apertura)
- Sistema antivibración
- Bajo nivel sonoro
- 3 niveles de estantes con frontal de madera de pino maciza
- Led vertical interior en 3000K continuo, que mejora la visibilidad de las botellas
- Refrigeración ventilada
- Bandeja de evaporación automática
- Control digital de temperatura, incorpora alarma de alta temperatura
- Dos rangos de temperatura disponibles: Vino Tinto (+10°C +18°C) o Vino Blanco, Rosado y Brut (+4°C +8°C)
- Clase climática 4 (30°C 55% HR)

- Exterior and interior in black plastic-coated steel (exterior wood optional)
- Ideal for horizontal / vertical wine bottle by adjusting said shelf, large storage capacity
- Frameless swing doors and full glass front with minimal black RAL 9005 screen printing with automatic closing system and magnetic gasket (remains open when opening more than 90°)
- Anti-vibration system
- Low sound level
- 3 levels of shelves with solid pine wood front
- Interior vertical LED in 3000K continuous, which improves the visibility of the bottles
- Ventilated cooling
- Automatic evaporation tray
- Digital temperature control, incorporates high temperature alarm
- Two temperature ranges available: Red Wine (+10°C +18°C) or White, Rosé and Brut Wine (+4°C +8°C)
- Climate class 4 (30°C 55% RH)

mod.	ext. lacado lacquered ext.	estante adicional extra shelf (ud)
CEFIW-1R	482 €	126 € x ud
CEFIW-2R	499 €	243 € x ud
CEFIW-3R	513 €	361 € x ud



Detalle estante inclinado  
Inclined shelf detail

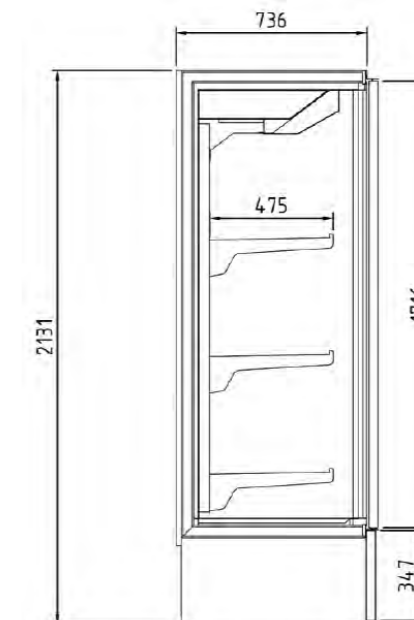





ASC-751 3.523 € ASCV-751 4.033 € ASC-S-751 3.008 € ASC-ES-752 4.372 €

mod.	largo length (mm)	alto height (mm)	fondo depth (mm)	estantes shelves	barras carniceras butcher bars	volumen capacity (L)	estufaje dripping	secado drying	voltaje voltage	rango range °C	capacidad capacity max. Kg.	refrigerante refrigerant	potencia frig. frig. power W	estufaje dripping max. W	secado drying max. W	clase 2015/1094 EN16825
ASC-751	680	2160	735	op.	3 KIT	505	✓	✓	230V-50Hz	+4°C +30°C	30	R290	845	531	1407	5 40°C 40%
ASCV-751	680	2160	735	op.	3 KIT	505	✓	✓	230V-50Hz	+4°C +30°C	30	R290	845	531	1407	5 40°C 40%
ASC-S-751	680	2160	735	op.	3 KIT	505	no	✓	230V-50Hz	+4°C +16°C	30	R290	845	-	907	5 40°C 40%
ASC-ES-752	680	2160	735	op.	2 KIT	245+245	✓	✓	230V-50Hz	+22°C +30°C	15	R290	255	531	560	5 40°C 40%
										+4°C +16°C	15	R290	255	-	655	5 40°C 40%

Características técnicas y constructivas sujetas a variación sin previo aviso.

We reserve the right to change specifications without prior notice.

- Exterior en acero inox AISI-304, excepto el respaldo y fondo
- Interior en acero inox AISI-304, con aristas curvas y fondo embutido
- Puertas de apertura reversible, con sistema de cierre automático y burlete magnético (permanece abierta al superar los 90° de apertura)
- Contrapuerta inox embutida
- ASCV: Luz interior LED tonos rojizos
- KITS barras carniceras (3 barras por cada Kit), estante opcionales.
- Pies en tubo de acero inox ajustables en altura 135- 200 mm
- Cuadro de mandos y rejilla ventilación motor, desmontables
- Unidad condensadora ventilada
- Resistencias para ciclo de estufaje, con termostato de seguridad de rearme automático (50°C OFF, 35°C ON)
- Ventiladores funcionamiento independiente frio- calor- humedad
- Estufaje con sistema para renovación y purificación de aire
- Evaporador sistema tiro forzado, con recubrimiento epoxi anticorrosión
- Paro ventiladores tiro forzado al abrir la puerta
- Evaporación automática del agua de descarche
- Aislamiento de poliuretano inyectado, densidad 40 Kg/m<sup>3</sup>, cero ODP y GWP
- 75 mm aislamiento en costados
- Control digital con eficiente gestión del consumo de energía y HACCP por conexión WIFI o BT (opcionales)
- 6 programas pre-configurados, reprogramables según necesidad del proceso.
- Cada programa cuenta con hasta 8 ciclos ajustables en tiempo, temperatura y humedad (sólo en modo secado)

- AISI-304 stainless steel exterior, except rear side and base
- AISI-304 stainless steel interior, with curved edges and embedded bottom
- Reversible opening doors, with automatic closing system and magnetic seal (remains open when opening over 90°)
- Embedded stainless steel door
- ASCV: Soft pink LED interior light
- Meat bars KITS (3 bars for each Kit), shelves on demand.
- Feet in stainless steel tube adjustable in height 135 - 200 mm
- Removable control panel and motor ventilation grille
- Ventilated condensing unit
- Resistances for dripping cycles, with automatic reset safety thermostat (50°C OFF, 35°C ON)
- Fans independent operation cold - heat - humidity
- Dripping process with air purification and renewal system
- Evaporator forced draft system, with anti-corrosion epoxy coating
- Forced draft fans stop when the door is opened
- Automatic evaporation of defrost water
- Injected polyurethane insulation, density 40 Kg / m<sup>3</sup>, zero ODP and GWP
- 75 mm insulation on sides
- Digital control, efficient management of energy consumption and HACCP by WIFI or BT module 8on demmand)
- 6 pre-set recipes, re-programables for particular curing process needs.
- Up to 8 phases for each recipe adjustables in time, temperature and humidity (only for drying)

- ASC y ASCV: un recinto para estufaje y secado
- ASC-S: un recinto sólo para secado
- ASC-ES: dos recintos independientes, una para estufaje y otro para secado

- ASC y ASCV: one section for dripping a drying
- ASC-S: one section just for dripping
- ASC-ES: two independent sections, one for dripping and one for drying



CICLO - CYCLE	renovación renewal	tiempo- time		temp.		humedad- humidity	
		min	max	min	max	min	max
ESTUFAJE - DRIPPING	si / yes	1 h	240 h	*22°C	*30°C	no	no
SECADO - DRYING	no	1 h	240 h	4°C	16°C	**50%	**90%

\*equipo frig. de apoyo- with frig device  
\*\*sin aporte exterior- no external inlet needed

OPCIONES	OPTIONS	€
parrilla adicional	additional shelf	37 €
parrilla intermedia adicional	extra middle shelf	21 €
barras carniceras	meat bars	140 €
set 4 ruedas	set 4 wheels	112 €
cerradura puerta inox	SS door lock	31 €
respaldo inox	SS rear side	consultar
230V 60Hz / 115V 60Hz	230V 60Hz / 115V 60Hz	consultar
Conexión WIFI o BT	WIFI or BT module	151 €



Estantes opcionales  
Optional shelves

+4°C  
+30°C

50%  
90%



ASC-ES-752



ASCV-1302

ASC-S-751





ASC-1302 5.206 € ASCV-1302 6.275 € ASC-S-1302 4.316 € ASC-ES-1303 6.108 €

mod.	largo length (mm)	alto height (mm)	fondo depth (mm)	estantes shelves	barras carniceras butcher bars	volumen capacity (L)	estufaje dripping	secado drying	voltaje voltage	rango range °C	capacidad capacity max. Kg.	refrigerante refrigerant	potencia frig. frig. power W	estufaje dripping max. W	secado drying max. W	clase 2015/1094 EN16825
ASC-1302	1370	2160	735	op.	3 KIT	1201	✓	✓	230V-50Hz	+4°C +30°C	60	R290	1004	781	1910	5 40°C 40%
ASCV-1302	1370	2160	735	op.	3 KIT	1201	✓	✓	230V-50Hz	+4°C +30°C	60	R290	1004	781	1910	5 40°C 40%
ASC-S-1302	1370	2160	735	op.	3 KIT	1201	no	✓	230V-50Hz	+4°C +16°C	60	R290	1004	-	1160	5 40°C 40%
ASC-ES-1303	1370	2160	735	op.	2 KIT	956+245	✓	✓	230V-50Hz	+22°C +30°C	45	R290	255	531	560	5 40°C 40%
										+4°C +16°C	15	R290	1004	-	1160	5 40°C 40%



Estantes opcionales Optional shelves

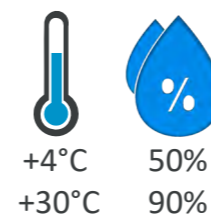

ASC-ES-1303



ASC-1302

ASC-S-1302



- Características técnicas y constructivas sujetas a variación sin previo aviso.
- Exterior en acero inox AISI-304, excepto el respaldo y fondo
  - Interior en acero inox AISI-304, con aristas curvas y fondo embutido
  - Puertas con sistema de cierre automático y burlete magnético (permanece abierta al superar los 90° de apertura)
  - Contrapuerta inox embutida
  - ASCV: Luz interior LED tonos rojos
  - KITS barras carniceras (3 barras por cada Kit), estante opcionales.
  - Pies en tubo de acero inox ajustables en altura 135- 200 mm
  - Cuadro de mandos y rejilla ventilación motor, desmontables
  - Unidad condensadora ventilada
  - Resistencias para ciclo de estufaje, con termostato de seguridad de rearme automático (50°C OFF, 35°C ON)
  - Ventiladores funcionamiento independiente frio- calor- humedad
  - Estufaje con sistema para renovación y purificación de aire
  - Evaporador sistema tiro forzado, con recubrimiento epoxi anticorrosión
  - Paro ventiladores tiro forzado al abrir la puerta
  - Evaporación automática del agua de descarche
  - Aislamiento de poliuretano inyectado, densidad 40 Kg/m<sup>3</sup>, cero ODP y GWP
  - 75 mm aislamiento en costados
  - Control digital con eficiente gestión del consumo de energía y HACCP por conexión WIFI o BT (opcionales)
  - 6 programas pre-configurados, reprogramables según necesidad del proceso.
  - Cada programa cuenta con hasta 8 ciclos ajustables en tiempo, temperatura y humedad (sólo en modo secado)

- We reserve the right to change specifications without prior notice.
- AISI-304 stainless steel exterior, except rear side and base
  - AISI-304 stainless steel interior, with curved edges and embedded bottom
  - Doors with automatic closing system and magnetic seal (remains open when opening over 90 °)
  - Embedded stainless steel door
  - ASCV: Soft pink LED interior light
  - Meat bars KITS (3 bars for each Kit), shelves on demand.
  - Feet in stainless steel tube adjustable in height 135 - 200 mm
  - Removable control panel and motor ventilation grille
  - Ventilated condensing unit
  - Resistances for dripping cycles, with automatic reset safety thermostat (50°C OFF, 35°C ON)
  - Fans independent operation cold - heat - humidity
  - Dripping process with air purification and renewal system
  - Evaporator forced draft system, with anti-corrosion epoxy coating
  - Forced draft fans stop when the door is opened
  - Automatic evaporation of defrost water
  - Injected polyurethane insulation, density 40 Kg / m<sup>3</sup>, zero ODP and GWP
  - 75 mm insulation on sides
  - Digital control, efficient management of energy consumption and HACCP by WIFI or BT module 8on demmand)
  - 6 pre-set recipes, re-programables for particular curing process needs.
  - Up to 8 phases for each recipe adjustables in time, temperature and humidity (only for drying)

- ASC y ASCV: un recinto para estufaje y secado
- ASC-S: un recinto sólo para secado
- ASC-ES: dos recintos independientes, una para estufaje y otro para secado

- ASC y ASCV: one section for dripping a drying
- ASC-S: one section just for dripping
- ASC-ES: two independent sections, one for dripping and one for drying



CICLO - CYCLE	renovación renewal	tiempo- time		temp.		humedad- humidity	
		min	max	min	max	min	max
ESTUFAJE - DRIPPING	si / yes	1 h	240 h	*22°C	*30°C	no	no
SECADO - DRYING	no	1 h	240 h	4°C	16°C	**50%	**90%

\*equipo frig. de apoyo- with frig device  
\*\*sin aporte exterior- no external inlet needed

OPCIONES	OPTIONS	€
parrilla adicional	additional shelf	37 €
parrilla intermedia adicional	extra middle shelf	21 €
barras carniceras	meat bars	140 €
set 5 ruedas	set 5 wheels	112 €
cerradura puerta inox	SS door lock	31 €
respaldo inox	SS rear side	consultar
230V 60Hz / 115V 60Hz	230V 60Hz / 115V 60Hz	consultar
Conexión WIFI o BT	WIFI or BT module	151 €





DAV-200-P 2.224 €



DAV-200 1.632 €



DAV-400 2.569 €

mod.	rango range °C	largo length (mm)	alto height (mm)	fondo depth (mm)	estantes shelves	barras carniceras butcher bars	volumen capacity (L)	capacidad carne meat capacity (Kg.)	voltaje voltage	refrigerante refrigerant	potencia frig. frig. power W	potencia power W	clase 2015/1094 EN16825
DAV-200	-2°C +8°C	600	900	650	1	1	120	20	230V-50Hz	R290 / R600a	255	190	4 30°C 55%
DAV-400	-2°C +8°C	600	1545	650	2	1	240	55	230V-50Hz	R290	502	241	4 30°C 55%

Características técnicas y constructivas sujetas a variación sin previo aviso.

We reserve the right to change specifications without prior notice.

Armarios expositores con temperatura de trabajo dentro del rango -2°+8°C y humedad entre 40% y 90% (sin aporte exterior de agua) Garantizan el control y la seguridad del proceso de envejecimiento de la carne (maduración), con la posibilidad de monitorizar de forma remota o in situ el funcionamiento y ajustes de los equipos, gracias al avanzado sistema de control que incorporan

Display cabinets with working temperature within the range -2°+ 8°C and humidity between 40% and 90% (without external water intake). This guarantee control and safety of the meat aging process, with the possibility of remotely or on-site monitoring of the operation and adjustments of the equipment, thanks to the incorporated advanced control system

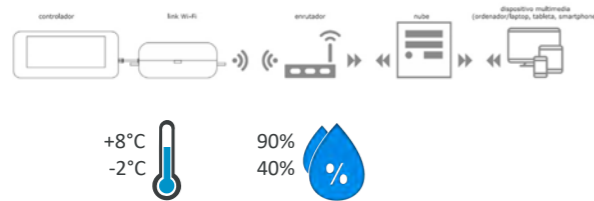

- Exterior en acero plastificado negro (inox opcional), excepto el respaldo
- Interior en acero inox AISI-304, con aristas curvas y fondo embutido
- Puertas de apertura reversible, con sistema de cierre automático y burlete magnético (permanece abierta al superar los 90° de apertura), con marco aluminio anodizado y doble cristal con tratamiento bajo-emisivo (reduce condensación de humedad)
- Doble luz interior LED tonos rojizos
- Estantes de acero AISI-304 y barras carniceras
- Bandeja y bloques de sal, opcionales
- Reguladores de altura
- Unidad condensadora ventilada
- Evaporador sistema tiro forzado, con recubrimiento epoxi anticorrosión y filtro de carbón activo
- Paro ventiladores tiro forzado al abrir la puerta
- Evaporación automática del agua de descarche
- Aislamiento de poliuretano inyectado, densidad 40 Kg/m<sup>3</sup>, cero ODP y GWP
- Control digital de temperatura y humedad, con eficiente gestión del consumo de energía y HACCP por conexión WIFI o BT (opcionales)

- Black coated steel (AISI-304 on demand) exterior, except rear side.
- AISI-304 stainless steel interior, with curved edges and embedded bottom
- Reversible opening doors, with automatic closing system and magnetic weatherstripping (remains open when opening over 90°), with anodized aluminum frame and triple glass with low-emission treatment (reduces moisture condensation)
- Double LED interior light, soft pink
- SS shelves and meat bar
- Salt blocks and tray, on demand
- Height adjusters
- Ventilated condensing unit
- Evaporator forced draft system, with anti-corrosion epoxy coating and carbon filter
- Forced draft fans stop when the door is opened
- Automatic evaporation of defrost water
- Injected polyurethane insulation, density 40 Kg / m<sup>3</sup>, zero ODP and GWP
- Digital temperature and humidity control, efficient management of energy consumption and HACCP by WIFI or BT module



DAV-200



DAV-200-P



DAV-400



DAW-400-NN + DA-200-NI + DAV-400-NI  
Combinan con armarios enfriadores de vino, pag. 120  
Combine with wine cooler cabinets, pag. 120



Exterior inox o lacado opcional SS exterior or lacquered on demand

OPCIONES	OPTIONS	€
módulo Bluetooth o WIFI	bluetooth or WIFI set	151 €
estante adicional	additional shelf	67 €
barras carniceras adicionales	additional bars	121 €
set 4 ruedas	4 castors set	112 €
bandeja para 2 bloques sal	tray for 2 salt blocks	75 €
bloque de sal 200x100x25	200x100x25 salt block	52 € x ud
exterior inox o lacado	SS exterior or lacquered	consultar
230v 60Hz / 115v 60Hz	230v 60Hz / 115v 60Hz	consultar



DA-400-II DA-400-NI	3.890 €	DA-750-II DA-750-NI	4.233 €	DA-1002-II DA-1002-NI	6.668 €	DA-2003-II DA-2003-NI	10.468 €
------------------------	---------	------------------------	---------	--------------------------	---------	--------------------------	----------

mod.	rango range °C	largo length (mm)	alto height (mm)	fondo depth (mm)	estantes shelves	barras carniceras butcher bars	volumen capacity (L)	capacidad carne meat capacity (Kg.)	voltaje voltage	refrigerante refrigerant	potencia frig. frig. power W	potencia power W	clase 2015/1094 EN16825
DA-400	-2°C +8°C	600	1900	650	2	1	320	75	230V-50Hz	R290	502	241	4 30°C 55%
DA-750	-2°C +8°C	680	2130	850	2	1	645	150	230V-50Hz	R290	502	290	4 30°C 55%
DA-1002	-2°C +8°C	1370	2130	850	4	2	1404	300	230V-50Hz	R290	1004	620	4 30°C 55%
DA-2003	-2°C +8°C	2055	2130	850	6	3	2197	450	230V-50Hz	R290	1702	1100	4 30°C 55%

Armarios expositores con temperatura de trabajo dentro del rango -2°+8°C y humedad entre 40% y 90% (sin aporte exterior de agua) Garantizan el control y la seguridad del proceso de envejecimiento de la carne (maduración), con la posibilidad de monitorizar de forma remota o in situ el funcionamiento y ajustes de los equipos, gracias al avanzado sistema de control que incorporan

Display cabinets with working temperature within the range -2°+ 8°C and humidity between 40% and 90% (without external water intake). This guarantee control and safety of the meat aging process, with the possibility of remotely or on-site monitoring of the operation and adjustments of the equipment, thanks to the incorporated advanced control system

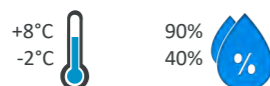

- Exterior en acero plastificado negro o inox, excepto el respaldo
- Interior en acero inox AISI-304, con aristas curvas y fondo embutido
- Puertas de apertura reversible (751), con sistema de cierre automático y burlete magnético (permanece abierta al superar los 90° de apertura), con marco aluminio anodizado y doble cristal con tratamiento bajo-emisivo (reduce condensación de humedad)
- Doble luz interior LED tonos rojizos
- Estantes de acero AISI-304 y barras carniceras
- Bandeja y bloques de sal, opcionales
- Unidad condensadora ventilada
- Evaporador sistema tiro forzado, con recubrimiento epoxi anticorrosión y filtro de carbón activo
- Paro ventiladores tiro forzado al abrir la puerta
- Evaporación automática del agua de descarche
- Aislamiento de poliuretano inyectado, densidad 40 Kg/m<sup>3</sup>, cero ODP y GWP
- Control digital de temperatura y humedad, con eficiente gestión del consumo de energía y HACCP por conexión WIFI o BT (opcionales)

- Black coated steel or AISI-304 exterior, except the rear side
- AISI-304 stainless steel interior, with curved edges and embedded bottom
- Reversible opening doors (751), with automatic closing system and magnetic weatherstripping (remains open when opening over 90°), with anodized aluminum frame and triple glass with low-emission treatment (reduces moisture condensation)
- Double LED interior light, soft pink
- SS shelves and meat bar
- Salt blocks and tray, on demnad
- Ventilated condensing unit
- Evaporator forced draft system, with anti-corrosion epoxy coating and carbon filter
- Forced draft fans stop when the door is opened
- Automatic evaporation of defrost water
- Injected polyurethane insulation, density 40 Kg / m<sup>3</sup>, zero ODP and GWP
- Digital temperature and humidity control, efficient management of energy consumption and HACCP by WIFI or BT module

OPCIONES	OPTIONS	€
módulo Bluetooth o WIFI	bluetooth or WIFI set	151 €
estante adicional DA400	DA400 extra shelf	68 €
DA750/1002/2003 estante extra	DA750/1002/2003 extra shelf	92 €
barras carniceras adicionales	additional bars	140 €
set 4 ruedas	4 castors set	112 €
set 5 ruedas	5 castors set	139 €
set 6 ruedas	6 castors set	166 €
bandeja para 3 bloques sal	tray for 3 salt blocks	93 €
bloque de sal 200x100x25	200x100x25 salt block	52 € x ud
exterior lacado	laquered exterior	consultar
230v 60Hz / 115v 60Hz	230v 60Hz / 115v 60Hz	consultar

STANDARD	
II	ext. inox + int. inox SS ext + SS interior
NI	ext. negro + int. inox black ext. + SS interior



DA-400-NI

DA-750-NI



Exterior inox o lacado opcional SS exterior or lacquered on demand





MRP-150 3.033 €  
MCP-150 3.761 €MRP-200 3.627 €  
MCP-200 4.403 €

MRP-250 4.374 €

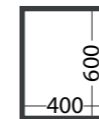
MRPV-150 3.495 €  
MCPV-150 4.374 €MRPV-200 4.294 €  
MCPV-200 5.273 €MRPV-250 5.202 €  
MCPV-250 5.844 €

mod.	rango range °C	largo length (mm)	alto height (mm)	fondo depth (mm)	estantes shelves 40x60	pares guías slides sets	volumen capacity (L)	voltaje voltage	refrigerante refrigerant	potencia frig. frig. power W	potencia power W	CCE EEC 2015/1094 EN16825	clase climate 2015/1094 EN16825
MRP-150	-2°C +8°C	1495	850	800	0	9	362	230V-50Hz	R290	502	187	A	5 40°C 40%
MRP-200	-2°C +8°C	2020	850	800	0	14	562	230V-50Hz	R290	502	190	B	5 40°C 40%
MRP-250	-2°C +8°C	2545	850	800	0	19	761	230V-50Hz	R290	845	320	B	5 40°C 40%
MRPV-150	-2°C +8°C	1495	850	800	0	9	362	230V-50Hz	R290	502	196	B	4 30°C 55%
MRPV-200	-2°C +8°C	2020	850	800	0	14	562	230V-50Hz	R290	502	203	C	4 30°C 55%
MRPV-250	-2°C +8°C	2545	850	800	0	19	761	230V-50Hz	R290	845	308	C	4 30°C 55%
MCP-150	-20°C -15°C	1495	850	800	0	9	362	230V-50Hz	R290	606	485	D	5 40°C 40%
MCP-200	-20°C -15°C	2020	850	800	0	14	562	230V-50Hz	R290	606	506	D	4 30°C 55%
MCPV-150	-20°C -15°C	1495	850	800	0	9	362	230V-50Hz	R290	606	494	D	4 30°C 55%
MCPV-200	-20°C -15°C	2020	850	800	0	14	562	230V-50Hz	R290	606	519	D	4 30°C 55%

Serigrafiado perimetral  
Perimetral serigraphy

MRPV-250

MRP-250  
exterior lacado y encimera, opcionales  
optional lacquered exterior and worktop

- Características técnicas y constructivas sujetas a variación sin previo aviso.
- Exterior en acero inox AISI-304, excepto el respaldo y fondo
  - Interior en acero inox AISI-304, con aristas curvas y fondo embutido
  - Puertas de apertura reversible, con sistema de cierre automático y burlete magnético (permanece abierta al superar los 90° de apertura)
  - Contrapuerta inox embutida
  - Encimera de acero inox AISI-304 con frente recto (opcional con peto)
  - Pies en tubo de acero inox ajustables en altura 135- 210 mm
  - Unidad condensadora ventilada y extraíble
  - Evaporador sistema tiro forzado, con recubrimiento epoxi anticorrosión
  - Evaporación automática del agua de descarche
  - Aislamiento de poliuretano inyectado, 40 Kg/m<sup>3</sup>, cero efectos ODP y GWP
  - Control digital de última generación, monitorización en tiempo real, anticipación a incidencias, reducción de averías y simplificación del mantenimiento y uso por APP en smartphone o Tablet
  - Temperatura ambiente de trabajo: **MRP / MCP** 40°C  
**MRPV / MCPV** 32°C

- We reserve the right to change specifications without prior notice.
- AISI-304 stainless steel exterior, except rear side and base
  - AISI-304 stainless steel interior, stamped bottom and rounded corners
  - Doors with self closing system, blocked opening, magnetic gasket and possibility of changing the opening sense
  - Inner side of doors by stamped steel
  - AISI-304 stainless steel worktop, with 90° front (optional with upstand)
  - AISI-304 adjustable legs, 135 to 210 mm
  - Removable and fan assisted condenser unit
  - Fan assisted evaporator, with epoxi anticorrosion coating.
  - Automatic evaporation of defrost water
  - 40 Kg/m<sup>3</sup> density polyurethane insulation, zero ODP and GWP
  - Next-generation digital control, real-time monitoring, issue anticipation, reduced breakdowns, simplified maintenance, and APP-based operation via smartphone or tablet.
  - Operating ambient temperature: **MRP / MCP** 40°C  
**MRPV / MCPV** 32°C

OPCIONES	OPTIONS	€
parrilla suplemento	shelf supplement	29 €
parrilla 60x40	shelf 60x40	29 €
set adicional guías 60x40	additional set slides 60x40	25 €
cerradura puerta inox	SS door lock	31 €
cerradura puerta cristal	glass door lock	63 €
motor lado izquierdo	left side motor	77 €
encimera con peto	worktop with splash-back	0 €
set 4 ruedas	set 4 wheels	112 €
set 6 ruedas	set 6 wheels	166 €
tropicalizado 43°C	tropicalized 43°C	consultar
230V 60Hz / 115V 60Hz	230V 60Hz / 115V 60Hz	consultar
respaldo inox	SS rear side	consultar
encimera de granito	granite countertop	consultar
exterior color blanco	white exterior	consultar
APPC	HACCP	incluido

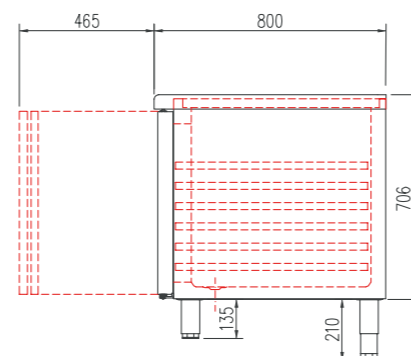
Encimera granito opcional  
Optional granite worktopCerradura opcional  
Optional lockEncimera con peto y rueda opcionales  
Optional castors and splashback



MRPP-120	2.289 €
MCPP-120	2.510 €



MRPP-170	2.881 €
MCPP-170	3.168 €



MRPP-220	3.480 €
MCPP-220	3.558 €



MRPPV-120	2.643 €
MCPPV-120	3.079 €



MRPPV-170	3.399 €
MCPPV-170	3.979 €



MRPPV-220	4.125 €
MCPPV-220	3.979 €

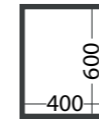

MRPP-220



MRPPV-220

Serigrafiado perimetral  
Perimetral serigraphy

mod.	rango range °C	largo length (mm)	alto height (mm)	fondo depth (mm)	estantes shelves 40x60	pares guías slides sets	volumen capacity (L)	voltaje voltage	potencia frig. frig. power
MRPP / MRPPV-120	-2°C +8°C	1195	850	800	0	9	255	230V-50Hz	502
MRPP / MRPPV-170	-2°C +8°C	1720	850	800	0	14	399	230V-50Hz	502
MRPP / MRPPV-220	-2°C +8°C	2245	850	800	0	19	543	230V-50Hz	845
MCPP / MCPPV-120	-20°C -15°C	1195	850	800	0	9	255	230V-50Hz	606
MCPP / MCPPV-170	-20°C -15°C	1720	850	800	0	14	399	230V-50Hz	606
MCPP / MCPPV-220	-20°C -15°C	2245	850	800	0	19	543	230V-50Hz	1309

Características técnicas y constructivas sujetas a variación sin previo aviso.

We reserve the right to change specifications without prior notice.

- MRPP / MCPP Contrapuerta inox embutida
- MRPPV / MCPPV doble cristal + LEDs

- MRPP / MCPP inner side of doors by stamped steel
- MRPPV / MCPPV double glazed doors + LEDs

- Exterior en acero inox AISI-304, excepto el respaldo y fondo
- Interior en acero inox AISI-304, con aristas curvas y fondo embutido
- Puertas de apertura reversible, con sistema de cierre automático y burlete magnético (permanece abierta al superar los 90° de apertura)
- Encimera de acero inox AISI-304 con frente recto (Opcional con peto sanitario 100 mm)
- Interior con guías de acero inox, regulables en altura para parrillas, bandejas o contenedores 60x40
- Pies en tubo de acero inox ajustables en altura 135- 210 mm
- Evaporador sistema tiro forzado, con recubrimiento epoxi anticorrosión
- Aislamiento de poliuretano inyectado, densidad 40 Kg/m<sup>3</sup>, cero efectos ODP y GWP
- Control digital de temperatura, descarches optimizados, alarma por alta temperatura de condensación (MRPP MCPP). Eficiente gestión del consumo de energía
- Unidad condensadora **NO INCLUIDA**
- Control de expansión de refrigerante **NO INCLUIDO**
- Rendimiento del evaporador con Δt=12°C
- Condiciones de trabajo: MRPP / MCPP 40°C ambiente  
MRPPV / MCPPV 32°C ambiente

- AISI-304 stainless steel exterior, except rear side and base
- AISI-304 stainless steel interior, stamped bottom and rounded corners
- Doors with self closing system, blocked opening, magnetic gasket and possibility of changing the opening sense
- AISI-304 stainless steel worktop, with 90° front (optional with 100 mm sanitary upstand)
- Capacity for 60x40 shelves, containers or trays by stainless steel slides, height adjustable
- AISI -304 adjustable legs, 135 to 210 mm
- Fan assisted evaporator, with epoxi anticorrosion coating.
- 40 Kg/m<sup>3</sup> density polyurethane insulation, zero ODP and GWP
- Digital temperature control, optimized defrost, high-temperature condensation alarm (MRPP MCPP). Efficient management of energy consumption
- Condenser unit **NOT INCLUDED**
- Refrigerant expansion control, **NOT INCLUDED**
- Performance of the evaporator with Δt=12°C
- Operating: MRPP / MCPP 40°C ambient  
MRPPV / MCPPV 32°C ambient

OPCIONES	OPTIONS	€
parrilla suplemento	shelf supplement	29 €
parrilla 60x40	shelf 60x40	29 €
set adicional guías 60x40	additional set slides 60x40	25 €
cerradura puerta inox	SS door lock	31 €
cerradura puerta cristal	glass door lock	63 €
conexiones lado izquierdo	left side connections	77 €
encimera con peto	worktop with splash-back	0 €
set 4 ruedas	set 4 wheels	112 €
set 6 ruedas	set 6 wheels	165 €
tropicalizado 43°C	tropicalized 43°C	consultar
230V 60Hz / 115V 60Hz	230V 60Hz / 115V 60Hz	consultar
respaldo inox	SS rear side	consultar
encimera de granito	granite countertop	consultar
exterior color blanco	white exterior	consultar
evaporación automática	automatic evaporation	186 €
APCC	HACCP	consultar

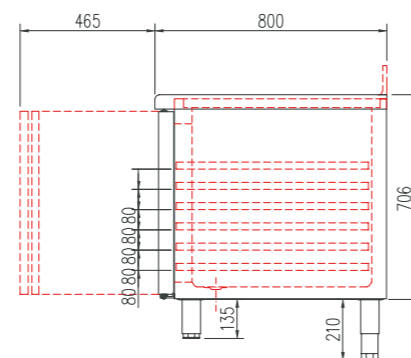



APR-750	3.153 €
APRV-750	3.621 €
APC-750	4.093 €



APRV-750-60x45	3.322 €
APRV-750-60x45	3.795 €
APC-750-60x45	4.264 €

mod.	rango range °C	largo length (mm)	alto height (mm)	fondo depth (mm)	estantes shelves	pares guías slides sets	volumen capacity (L)	voltaje voltage	refrigerante refrigerant	potencia frig. frig. power W	potencia power W	CCE 2015/1094 EN16825	clase 2015/1094 EN16825
APR-750	-2°C +8°C	680	2130	860	-	20	645	230V-50Hz	R290	845	429	C	5 40°C 40%
APRV-750	-2°C +8°C	680	2130	860	-	20	645	230V-50Hz	R290	502	193	C	4 30°C 55%
APC-750	-20°C -15°C	680	2130	860	-	20	645	230V-50Hz	R290	606	503	E	4 30°C 55%

## Características técnicas y constructivas sujetas a variación sin previo aviso.

- Exterior en acero inox AISI-304, excepto el respaldo y fondo
- Interior en acero inox AISI-304, con aristas curvas y fondo embutido
- Puertas de apertura reversible, con sistema de cierre automático y burlete magnético (permanece abierta al superar los 90° de apertura)
- APRV: puerta marco de aluminio con cristal doble + LEDS
- Cerradura con llave, de serie
- Contrapuerta inox embutida
- Luz interior LED
- Interior con guías de acero inox, regulables en altura cada 60 mm para parrillas, bandejas o contenedores 60x40 o 60x45, según modelo
- Pies en tubo de acero inox ajustables en altura 135- 200 mm
- Cuadro de mandos elevable
- Unidad condensadora ventilada
- Evaporador sistema tiro forzado, con recubrimiento epoxi anticorrosión
- Paro ventiladores tiro forzado al abrir la puerta
- Evaporación automática del agua de descarche
- Poliuretano inyectado, densidad 40 Kg/m<sup>3</sup>, cero efectos ODP y GWP
- 75 mm aislamiento perimetral
- Control digital de última generación, monitorización en tiempo real, anticipación a incidencias, reducción de averías y simplificación del mantenimiento y uso por APP en smartphone o Tablet

## We reserve the right to change specifications without prior notice.

- AISI-304 stainless steel exterior, except rear side and base
- AISI-304 stainless steel interior, stamped bottom and rounded corners
- Doors with self closing system, blocked opening, magnetic gasket and possibility of changing the opening sense (751)
- APRV: double glazed door on aluminium frame and LED lighting
- Key lock as standard
- Inner side of doors by stamped steel
- LED lighting
- Capacity for 60x40 or 60x45 (see model) by stainless steel slides, 60 mm height adjustable
- AISI -304 adjustable legs, 135 to 200 mm
- Lifiable control panel
- Fan assisted condenser unit
- Fan assisted evaporator, with epoxi anticorrosion coating
- Evaporator fan stops when door is opened
- Automatic evaporation of defrost water
- 40 Kg/m<sup>3</sup> density polyurethane, zero ODP and GWP
- 75 mm perimetral insulation
- Next-generation digital control, real-time monitoring, issue anticipation, reduced breakdowns, simplified maintenance, and APP-based operation via smartphone or tablet.

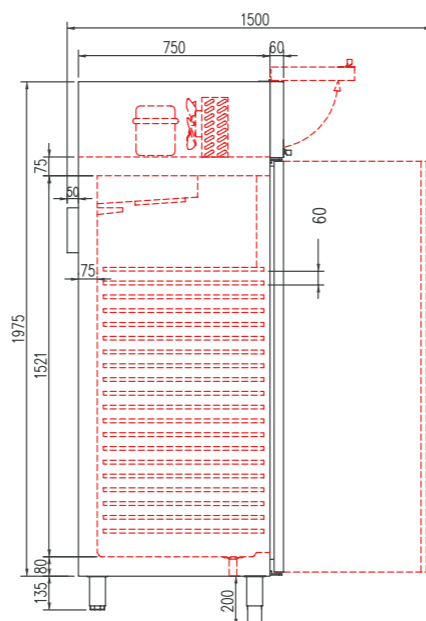

OPCIONES	OPTIONS	€
set adicional guías 60x40	additional set slides 60x40	25 €
parrilla 60x40	shelf 60x40	29 €
set 4 ruedas	set 4 wheels	112 €
respaldo inox	SS rear side	consultar
tropicalizado 43°C	tropicalized 43°C	consultar
230V 60Hz / 115V 60Hz	230V 60Hz / 115V 60Hz	consultar
pedal apertura puerta	door opening pedal	212 €
APPC	HACCP	incluido



APRV-750-60x45



APR-1002	5.192 €
APRV-1002	6.248 €
APC-1002	6.207 €



APR-1002-60x45	5.530 €
APRV-1002-60x45	6.600 €
APC-1002-60x45	6.545 €

mod.	rango range °C	largo length (mm)	alto height (mm)	fondo depth (mm)	estantes shelves	pares guías slides sets	volumen capacity (L)	voltaje voltage	refrigerante refrigerant	potencia frig. frig. power W	potencia power W	CCE 2015/1094 EN16825	clase 2015/1094 EN16825
APR-1002	-2°C +8°C	1370	2130	860	-	40	1404	230V-50Hz	R290	845	323	D	5 40°C 40%
APC-1002	-20°C -15°C	1370	2130	860	-	40	1404	230V-50Hz	R290	907	870	E	4 30°C 55%

## Características técnicas y constructivas sujetas a variación sin previo aviso.

- Exterior en acero inox AISI-304, excepto el respaldo y fondo
- Interior en acero inox AISI-304, con aristas curvas y fondo embutido
- Puertas con sistema de cierre automático y burlete magnético (permanece abierta al superar los 90° de apertura)
- APRV: puerta marco de aluminio con cristal doble + LEDS
- Cerradura con llave, de serie
- Contrapuerta inox embutida
- Luz interior LED
- Interior con guías de acero inox, regulables en altura cada 60 mm para parrillas, bandejas o contenedores 60x40 o 60x45, según modelo
- Pies en tubo de acero inox ajustables en altura 135- 200 mm
- Cuadro de mandos elevable
- Unidad condensadora ventilada
- Evaporador sistema tiro forzado, con recubrimiento epoxi anticorrosión
- Paro ventiladores tiro forzado al abrir la puerta
- Evaporación automática del agua de descarche
- Poliuretano inyectado, densidad 40 Kg/m<sup>3</sup>, cero efectos ODP y GWP
- 75 mm aislamiento perimetral
- Control digital de última generación, monitorización en tiempo real, anticipación a incidencias, reducción de averías y simplificación del mantenimiento y uso por APP en smartphone o Tablet

## We reserve the right to change specifications without prior notice.

- AISI-304 stainless steel exterior, except rear side and base
- AISI-304 stainless steel interior, stamped bottom and rounded corners
- Doors with self closing system, blocked opening and magnetic gasket
- APRV: double glazed door on aluminium frame and LED lighting
- Key lock as standard
- Inner side of doors by stamped steel
- LED lighting
- Capacity for 60x40 or 60x45 (see model) by stainless steel slides, 60 mm height adjustable
- AISI -304 adjustable legs, 135 to 200 mm
- Lifiable control panel
- Fan assisted condenser unit
- Fan assisted evaporator, with epoxi anticorrosion coating
- Evaporator fan stops when door is opened
- Automatic evaporation of defrost water
- 40 Kg/m<sup>3</sup> density polyurethane, zero ODP and GWP
- 75 mm perimetral insulation
- Next-generation digital control, real-time monitoring, issue anticipation, reduced breakdowns, simplified maintenance, and APP-based operation via smartphone or tablet.

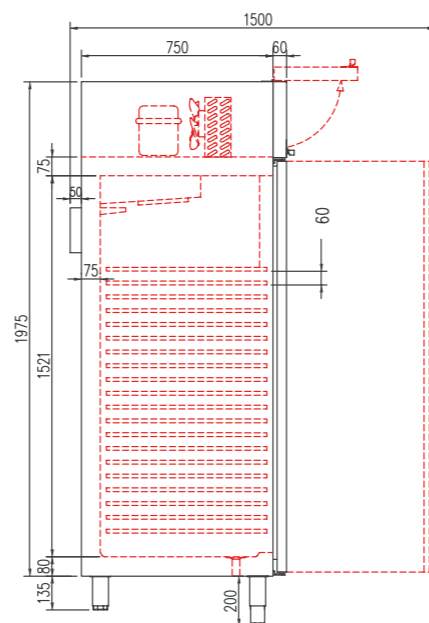

OPCIONES	OPTIONS	€
set adicional guías 60x40	additional set slides 60x40	25 €
parrilla 60x40	shelf 60x40	29 €
set 4 ruedas	set 4 wheels	112 €
respaldo inox	SS rear side	consultar
tropicalizado 43°C	tropicalized 43°C	consultar
230V 60Hz / 115V 60Hz	230V 60Hz / 115V 60Hz	consultar
pedal apertura puerta	door opening pedal	212 €
APPC	HACCP	incluido



APRV-1002 60x45



APR-950	3.525 €
APC-950	4.334 €



APRV-950	3.875 €
----------	---------

mod.	rango range °C	largo length (mm)	alto height (mm)	fondo depth (mm)	estantes shelves	pares guías slides sets	volumen capacity (L)	voltaje voltage	refrigerante refrigerant	potencia frig. frig. power W	potencia power W	CCE 2015/1094 EN16825	clase 2015/1094 EN16825
APR-950	-2°C +8°C	812	2130	1015	-	20	870	230V-50Hz	R290	1004	680	D	5 40°C 40%
APRV-950	-2°C +8°C	812	2130	1015	-	20	870	230V-50Hz	R290	1004	694	D	5 40°C 40%
APC-950	-20°C -15°C	812	2130	1015	-	20	870	230V-50Hz	R290	907	1139	D	4 30°C 55%

## Características técnicas y constructivas sujetas a variación sin previo aviso.

- Exterior en acero inox AISI-304, excepto el respaldo y fondo
- Interior en acero inox AISI-304, con aristas curvas y fondo embutido
- Puertas con sistema de cierre automático y burlete magnético (permanece abierta al superar los 90° de apertura)
- APRV: puerta marco de aluminio con cristal doble + LEDS
- Cerradura con llave, de serie
- Contrapuerta inox embutida
- Luz interior LED
- Interior con guías de acero inox, regulables en altura cada 60 mm para parrillas, bandejas o contenedores 60x80
- Pies en tubo de acero inox ajustables en altura 135- 200 mm
- Cuadro de mandos elevable
- Unidad condensadora ventilada
- Evaporador sistema tiro forzado, con recubrimiento epoxi anticorrosión
- Paro ventiladores tiro forzado al abrir la puerta
- Evaporación automática del agua de descarche
- Poliuretano inyectado, densidad 40 Kg/m<sup>3</sup>, cero efectos ODP y GWP
- 75 mm aislamiento perimetral
- Control digital de última generación, monitorización en tiempo real, anticipación a incidencias, reducción de averías y simplificación del mantenimiento y uso por APP en smartphone o Tablet

## We reserve the right to change specifications without prior notice.

- AISI-304 stainless steel exterior, except rear side and base
- AISI-304 stainless steel interior, stamped bottom and rounded corners
- Doors with self closing system, blocked opening and magnetic gasket
- APRV: double glazed door on aluminium frame and LED lighting
- Key lock as standard
- Inner side of doors by stamped steel
- LED lighting
- Capacity for 60x80 by stainless steel slides, 60 mm height adjustable
- AISI -304 adjustable legs, 135 to 200 mm
- Lifiable control panel
- Fan assisted condenser unit
- Fan assisted evaporator, with epoxi anticorrosion coating
- Evaporator fan stops when door is opened
- Automatic evaporation of defrost water
- 40 Kg/m<sup>3</sup> density polyurethane, zero ODP and GWP
- 75 mm perimetral insulation
- Next-generation digital control, real-time monitoring, issue anticipation, reduced breakdowns, simplified maintenance, and APP-based operation via smartphone or tablet.

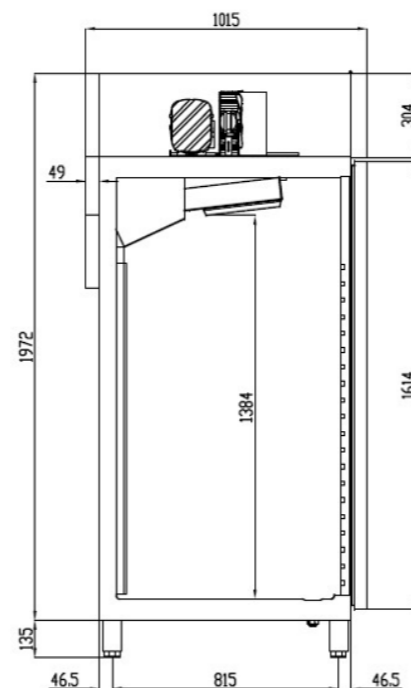

OPCIONES	OPTIONS	€
set adicional guías 60x40	additional set slides 60x40	25 €
parrilla 60x40	shelf 60x40	29 €
parrilla 60x80	shelf 60x80	59 €
set 4 ruedas	set 4 wheels	112 €
respaldo inox	SS rear side	consultar
tropicalizado 43°C	tropicalized 43°C	consultar
230V 60Hz / 115V 60Hz	230V 60Hz / 115V 60Hz	consultar
pedal apertura puerta	door opening pedal	212 €
APPCC	HACCP	incluido



APRV-950  
Con parrillas opcionales  
With optional shelves



APR-950  
Con parrillas opcionales  
With optional shelves



APR-950-PT 3.737 €



APRV-950-PT 4.343 €

mod.	rango range °C	largo length (mm)	alto height (mm)	fondo depth (mm)	estantes shelves	pares guías slides sets	volumen capacity (L)	voltaje voltage	refrigerante refrigerant	potencia frig. frig. power W	potencia power W	CCE 2015/1094 EN16825	clase 2015/1094 EN16825
APR-950-PT	-2°C +8°C	812	2130	1025	-	20	935	230V-50Hz	R290	584	420	-	5 40°C 40%
APRV-950-PT	-2°C +8°C	812	2130	1025	-	20	935	230V-50Hz	R290	584	420	-	4 30°C 55%

## Características técnicas y constructivas sujetas a variación sin previo aviso.

- Exterior en acero inox AISI-304, excepto el respaldo y fondo
- Interior en acero inox AISI-304, con aristas curvas y fondo embutido
- Puertas A DOS CARAS con sistema de cierre automático y burlete magnético (permanece abierta al superar los 90° de apertura)
- APRV: puerta marco de aluminio con cristal doble + LEDS
- Cerradura con llave, de serie
- Contrapuerta inox embutida
- Luz interior LED
- Interior con guías de acero inox, regulables en altura cada 60 mm para parrillas, bandejas o contenedores 60x80
- Pies en tubo de acero inox ajustables en altura 135- 200 mm
- Cuadro de mandos elevable
- Unidad condensadora ventilada
- Evaporador y unidad condensadora sistema MONOBLOCK
- Paro ventiladores tiro forzado al abrir la puerta
- Evaporación automática del agua de descarche
- Poliuretano inyectado, densidad 40 Kg/m<sup>3</sup>, cero efectos ODP y GWP
- 75 mm aislamiento perimetral
- Control digital de última generación, monitorización en tiempo real, anticipación a incidencias, reducción de averías y simplificación del mantenimiento y uso por APP en smartphone o Tablet

## We reserve the right to change specifications without prior notice.

- AISI-304 stainless steel exterior, except rear side and base
- AISI-304 stainless steel interior, stamped bottom and rounded corners
- DOUBLE SIDE doors with self closing system, blocked opening and magnetic gasket
- APRV: double glazed door on aluminium frame and LED lighting
- Key lock as standard
- Inner side of doors by stamped steel
- LED lighting
- Capacity for 60x80 by stainless steel slides, 60 mm height adjustable
- AISI -304 adjustable legs, 135 to 200 mm
- Lifiable control panel
- Fan assisted condenser unit
- MONOBLOCK system evaporator and condensing unit
- Evaporator fan stops when door is opened
- Automatic evaporation of defrost water
- 40 Kg/m<sup>3</sup> density polyurethane, zero ODP and GWP
- 75 mm perimetral insulation
- Next-generation digital control, real-time monitoring, issue anticipation, reduced breakdowns, simplified maintenance, and APP-based operation via smartphone or tablet.

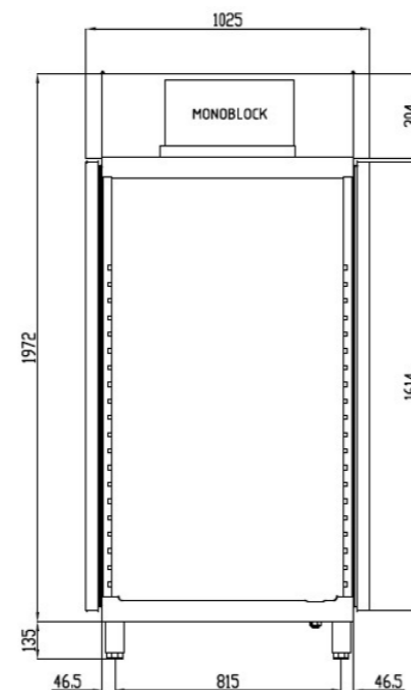
Otros modelos PASANTES, ver pag 100  
Other PASSTHRU models, see page 100

OPCIONES	OPTIONS	€
set adicional guías 60x40	additional set slides 60x40	25 €
parrilla 60x40	shelf 60x40	29 €
parrilla 60x80	shelf 60x80	59 €
set 4 ruedas	set 4 wheels	112 €
respaldo inox	SS rear side	consultar
tropicalizado 43°C	tropicalized 43°C	consultar
230V 60Hz / 115V 60Hz	230V 60Hz / 115V 60Hz	consultar
pedal apertura puerta	door opening pedal	212 €
APCC	HACCP	incluido

APRV-950-PT  
Con parrillas opcionales  
With optional shelvesAPR-950-PT  
Con parrillas opcionales  
With optional shelves



AIC-750 4.092 €



AIC-950 4.334 €

mod.	rango range °C	largo length (mm)	alto height (mm)	fondo depth (mm)	estantes shelves	pares guías slides sets	capacidad capacity (uds)	volumen capacity (L)	voltaje voltage	refrigerante refrigerant	potencia frig. frig. power W	potencia power W	CCE 2015/1094 EN16825	clase 2015/1094 EN16825
AIC-750	-25°C -10°C	680	2130	853	6	6	36	565	230V-50Hz	R290	700	740	D	4 30°C 55%
AIC-950	-25°C -10°C	812	2130	1015	6	6	54	870	230V-50Hz	R290	907	1139	D	4 30°C 55%

Características técnicas y constructivas sujetas a variación sin previo aviso.

- Exterior en acero inox AISI-304, excepto el respaldo y fondo
- Interior en acero inox AISI-304, con aristas curvas y fondo embutido
- Puertas con sistema de cierre automático y burlete magnético (permanece abierta al superar los 90° de apertura)
- Cerradura con llave, de serie
- Contrapuerta inox embutida
- Luz interior LED
- Interior con guías de acero inox, regulables en altura cada 140 mm para parrillas
- Pies en tubo de acero inox ajustables en altura 135- 200 mm
- Cuadro de mandos elevable
- Unidad condensadora ventilada
- Evaporador sistema tiro forzado, con recubrimiento epoxi anticorrosión
- Paro ventiladores tiro forzado al abrir la puerta
- Evaporación automática del agua de descarche
- Poliuretano inyectado, densidad 40 Kg/m<sup>3</sup>, cero efectos ODP y GWP
- 75 mm aislamiento perimetral
- Control digital de última generación, monitorización en tiempo real, anticipación a incidencias, reducción de averías y simplificación del mantenimiento y uso por APP en smartphone o Tablet

AIC-750: parrillas 530x650 GN2/1  
AIC-950: parrillas 600x400 / 600x800

We reserve the right to change specifications without prior notice.

- AISI-304 stainless steel exterior, except rear side and base
- AISI-304 stainless steel interior, stamped bottom and rounded corners
- Doors with self closing system, blocked opening and magnetic gasket
- Key lock as standard
- Inner side of doors by stamped steel
- LED lighting
- Interior with stainless steel slides, 140 mm height adjustable
- AISI -304 adjustable legs, 135 to 200 mm
- Lifiable control panel
- Fan assisted condenser unit
- Fan assisted evaporator, with epoxi anticorrosion coating
- Evaporator fan stops when door is opened
- Automatic evaporation of defrost water
- 40 Kg/m<sup>3</sup> density polyurethane, zero ODP and GWP
- 75 mm perimetral insulation
- Next-generation digital control, real-time monitoring, issue anticipation, reduced breakdowns, simplified maintenance, and APP-based operation via smartphone or tablet.

AIC-750: 530x650 GN2/1 shelves  
AIC-950: 600x400 / 600x800 shelves

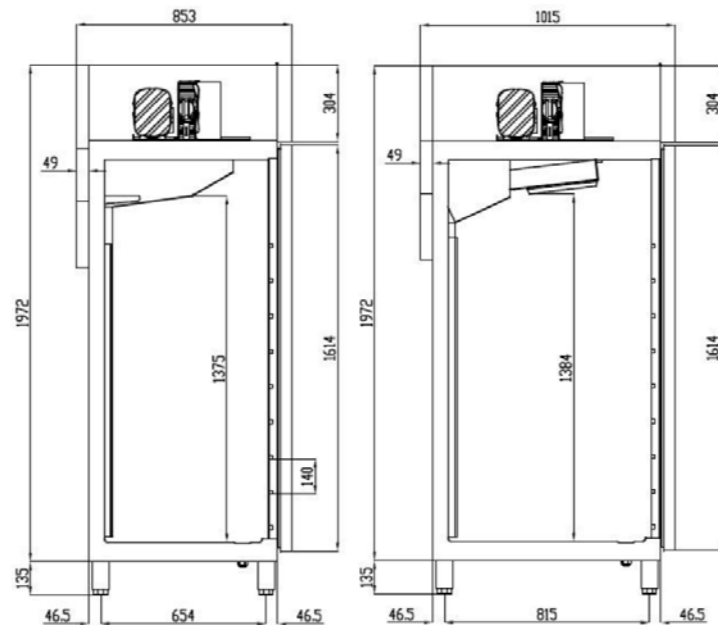

AIC-950  
Con cubetas helado 5 litros (no incluidas)  
With ice-cream 5 litres trays (not included)





APRF-750 6.898 €



APRF-950 7.140 €

mod.	rango range °C	largo length (mm)	alto height (mm)	fondo depth (mm)	estantes shelves	pares guías slides sets	volumen capacity (L)	voltaje voltage	refrigerante refrigerant	potencia frig. frig. power W	potencia frig. frig. power W	potencia cal. heat. power W	clase 2015/1094 EN16825	
APRF-750	-10°C +30°C	40% 99%	680	2130	965	-	20	565	230V-50Hz	R290	584	465	643	5 40°C 40%
APRF-950	-10°C +30°C	40% 99%	812	2130	1125	-	20	870	230V-50Hz	R290	942	575	645	4 30°C 55%

## Características técnicas y constructivas sujetas a variación sin previo aviso.

- Exterior en acero inox AISI-304, excepto el respaldo y fondo
- Interior en acero inox AISI-304, con aristas curvas y fondo embutido
- Puertas con sistema de cierre automático y burlete magnético (permanece abierta al superar los 90° de apertura)
- Cerradura con llave, de serie
- Contrapuerta inox embutida
- Luz interior LED
- Interior con guías de acero inox, regulables en altura cada 60 mm
- Pies en tubo de acero inox ajustables en altura 135- 200 mm
- Cuadro de mandos elevable
- Unidad condensadora y evaporador sistema MONOBLOCK
- Humidificador nebulizador por ultrasonidos, necesita aporte exterior de agua desmineralizada
- Paro ventiladores tiro forzado al abrir la puerta
- Evaporación automática del agua de descarche
- Poliuretano inyectado, densidad 40 Kg/m<sup>3</sup>, cero efectos ODP y GWP
- 75 mm aislamiento perimetral
- Control digital de temperatura y humedad, alarma por puerta abierta y alta temperatura de condensación. Eficiente gestión del consumo de energía

## We reserve the right to change specifications without prior notice.

- AISI-304 stainless steel exterior, except rear side and base
- AISI-304 stainless steel interior, stamped bottom and rounded corners
- Doors with self closing system, blocked opening and magnetic gasket
- Key lock as standard
- Inner side of doors by stamped steel
- LED lighting
- Stainless steel slides, 60 mm height adjustable
- AISI -304 adjustable legs, 135 to 200 mm
- Lifiable control panel
- MONOBLOCK system condenser unit and evaporator
- Ultrasonic nebulizing humidifier requiring an external supply of demineralized water
- Evaporator fan stops when door is opened
- Automatic evaporation of defrost water
- 40 Kg/m<sup>3</sup> density polyurethane, zero ODP and GWP
- 75 mm perimetral insulation
- Digital temperature and humidity control, door open and high-temperature condensation alarms. Efficient management of energy consumption

APRF-750: parrillas 600x400  
AIC-950: parrillas 600x400 / 600x800

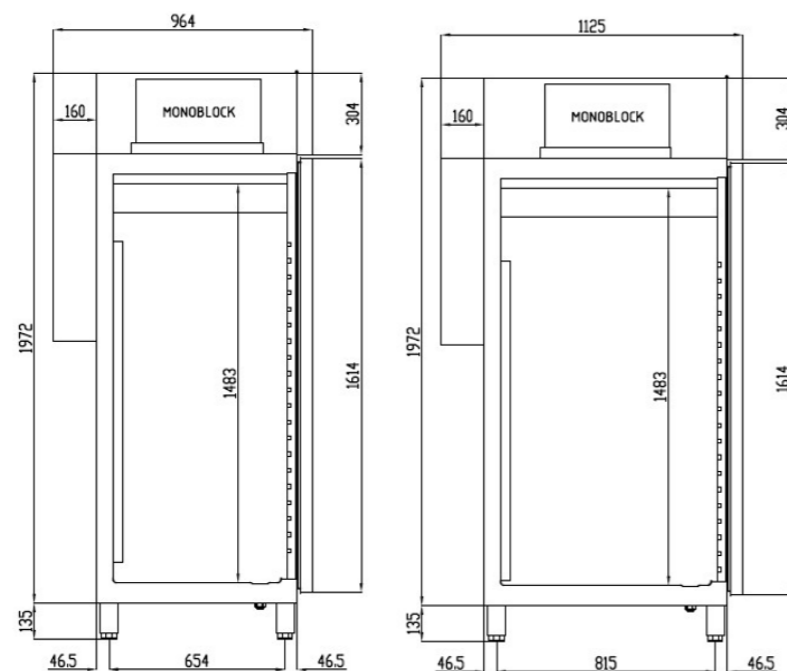
APRF-950  
Dotación estándar  
Standard sets of slides



ARC-1P	6.245 €
ACC-1P	6.245 €

ARC-2P	9.092 €
ACC-2P	10.612 €

mod.	rango range °C	largo length (mm)	alto height (mm)	fondo depth (mm)	estantes shelves	pares guías slides sets	voltaje voltage	refrigerante refrigerant	potencia frig. frig. power W	potencia frig. frig. power W	clase 2015/1094 EN16825
ARC-1P	-2°C +8°C	940	2450	1045	-	-	230V-50Hz	R290	1004	680	5 40°C 40%
ARC-2P	-2°C +8°C	1940	2450	1045	-	-	230V-50Hz	R290	1710	1180	5 40°C 40%
ACC-1P	-20°C -10°C	940	2450	1045	-	-	230V-50Hz	R290	907	1139	5 40°C 40%
ACC-2P	-20°C -10°C	1940	2450	1045	-	-	230V-50Hz	R290	1814	1750	5 40°C 40%

Características técnicas y constructivas sujetas a variación sin previo aviso.

- Exterior e interior en acero inox AISI-304,
- Puertas con sistema de cierre automático y burlete magnético (permanece abierta al superar los 90° de apertura)
- Cerradura con llave, de serie
- Contrapuerta inox embutida
- Paragolpes interiores
- Fondo acero inox reforzado
- Cuadro de mandos elevable
- Evaporador sistema tiro forzado, con recubrimiento epoxi anticorrosión
- Paro ventiladores tiro forzado al abrir la puerta
- Evaporación automática del agua de descarche
- Poliuretano inyectado, densidad 40 Kg/m<sup>3</sup>, cero efectos ODP y GWP
- 80 mm aislamiento perimetral
- Control digital de última generación, monitorización en tiempo real, anticipación a incidencias, reducción de averías y simplificación del mantenimiento y uso por APP en smartphone o Tablet

We reserve the right to change specifications without prior notice.

- AISI-304 stainless steel exterior and interior
- Doors with self closing system, blocked opening and magnetic gasket
- Key lock as standard
- Inner side of doors by stamped steel
- Internal bumpers
- AISI -304 reinforced bottom
- Lifiable control panel
- Fan assisted evaporator, with epoxi anticorrosion coating
- Evaporator fan stops when door is opened
- Automatic evaporation of defrost water
- 40 Kg/m<sup>3</sup> density polyurethane, zero ODP and GWP
- 80mm perimetral insulation
- Next-generation digital control, real-time monitoring, issue anticipation, reduced breakdowns, simplified maintenance, and APP-based operation via smartphone or tablet.



GOURMET 4

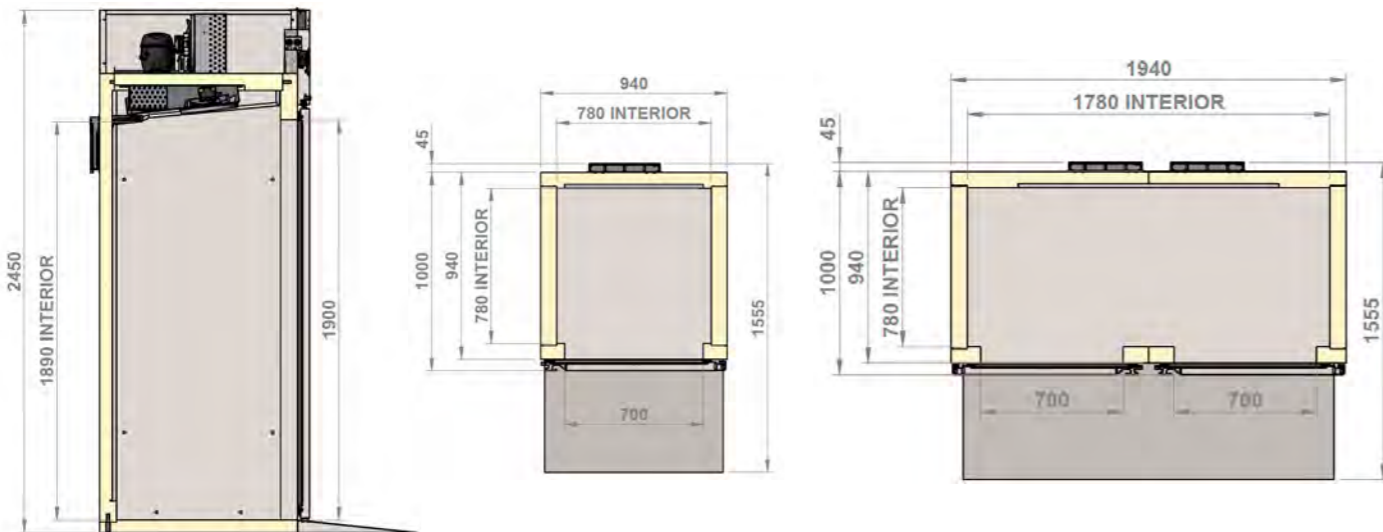



ARC-1P-PT 6.995 €

mod.	rango range °C	largo length (mm)	alto height (mm)	fondo depth (mm)	estantes shelves	pares guías slides sets	voltaje voltage	refrigerante refrigerant	potencia frig. frig. power W	potencia frig. frig. power W	clase 2015/1094 EN16825
ARC-1P-PT	-2°C +8°C	940	2450	1045	-	-	230V-50Hz	R290	584	420	5 40°C 40%

Características técnicas y constructivas sujetas a variación sin previo aviso.

- Exterior e interior en acero inox AISI-304,
- Puertas con sistema de cierre automático y burlete magnético (permanece abierta al superar los 90° de apertura)
- Cerradura con llave, de serie
- Contrapuerta inox embutida
- Paragolpes interiores
- Fondo acero inox reforzado
- Cuadro de mandos elevable
- Unidad condensadora y evaporador sistema MONOBLOCK
- Paro ventiladores tiro forzado al abrir la puerta
- Evaporación automática del agua de descarche
- Poliuretano inyectado, densidad 40 Kg/m<sup>3</sup>, cero efectos ODP y GWP
- 80 mm aislamiento perimetral
- Control digital de última generación, monitorización en tiempo real, anticipación a incidencias, reducción de averías y simplificación del mantenimiento y uso por APP en smartphone o Tablet

We reserve the right to change specifications without prior notice.

- AISI-304 stainless steel exterior and interior
- Doors with self closing system, blocked opening and magnetic gasket
- Key lock as standard
- Inner side of doors by stamped steel
- Internal bumpers
- AISI -304 reinforced bottom
- Lifiable control panel
- Fan assisted evaporator, with epoxi anticorrosion coating
- MONOBLOCK system condenser unit and evaporator
- Automatic evaporation of defrost water
- 40 Kg/m<sup>3</sup> density polyurethane, zero ODP and GWP
- 80mm perimetral insulation
- Next-generation digital control, real-time monitoring, issue anticipation, reduced breakdowns, simplified maintenance, and APP-based operation via smartphone or tablet.

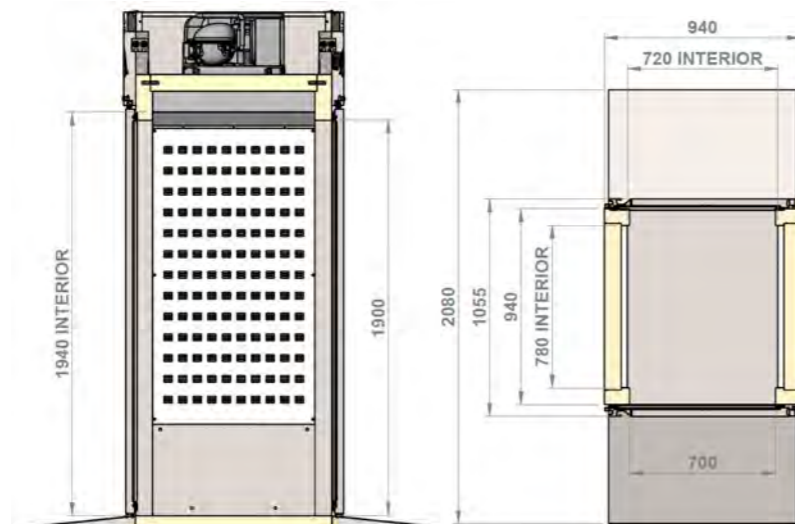



CEAP-175-V 2.223 €  
CEAPI-175-V 2.367 €



CEAP-100-H 2.034 €  
CEAPI-100-H 2.386 €

mod.	rango range °C	largo length (mm)	alto height (mm)	fondo depth (mm)	peso (vacío) weight (empty) Kg	potencia frig frig power W	consumo consumption W	capacidad capacity L	caudal grifo abierto open flow faucet (l/h) ΔT=10°C	voltaje voltage	refrigerante refrigerant
CEAP-175V	+1°C +3°C	880	1140	560	103	1012	594	175	110	230V-50Hz	R-290
CEAP-100H	+1°C +3°C	1405	580	565	100	583	346	100	79	230V-50Hz	R-290

Temperatura máxima entrada del agua de red 15°C  
Max inlet water temperature 15°C

Características técnicas y constructivas sujetas a variación sin previo aviso.

We reserve the right to change specifications without prior notice.

- **CEAPI:** Exterior en acero inox AISI-304
- **CEAP:** exterior en acero plastificado o acero plastificado

- **CEAPI:** Exterior in AISI-304 stainless steel
- **CEAP:** plasticed exterior

- Serpentin interior en acero inox AISI-304
- Aislamiento de poliuretano inyectado, densidad 40 Kg/m<sup>3</sup>, cero efectos ODP y GWP
- Llenado automático por boya, diámetro 1/2"
- Agitador de agua interior
- Control digital electrónico
- Encimera desmontable
- Rebosadero de seguridad diámetro 3/4"

- AISI-304 stainless steel Internal coil and container
- 40 Kg/m<sup>3</sup> density polyurethane insulation, zero ODP and GWP
- Automatic fill, float system, 1/2" diameter
- Interior water shaker
- Digital electronic control
- Detachable worktop
- Safety overflow, diameter 3/4"



soporte pared wall support 130 €

