



CORECO



FAST & cool FOOD

SALADETTE

- Pag. **58-59** Mesa fría SALADETTE GN1/1
GN 1/1 SALADETTE counter
- Pag. **60-61** Mesa fría SALADETTE GN1/1 encimera abierta
Open worktop GN 1/1 SALADETTE counter

KEBAB

- Pag. **62-63** Mesa fría GN 1/1 COMPACTA KEBAB
GN 1/1 KEBAB STATION
- Pag. **64-65** Mesa fría KEBAB GN1/1
GN 1/1 KEBAB counter

SALAD CHEFF

- Pag. **66-67** Mesa preparación con tapa cristal elevable
Preparation counter with liftable glass lid
- Pag. **68-69** Mesa fría SALAD-CHEFF GN1/1 encimera abierta
Open worktop GN 1/1 SALAD-CHEFF counter
- Pag. **70-71** Mesa fría SALAD-CHEFF GAMA 60 - 70
60 - 70 RANGE SALAD-CHEFF counter
- Pag. **72-73** Mesa fría SALAD-CHEFF 1/6
1/6 SALAD-CHEFF counter
- Pag. **74-75** Mesa fría BIG SALAD-PIZZA CHEFF gama 80
80 RANGE BIG SALAD-PIZZA CHEFF counter

PIZZA

- Pag. **76-77** Mesa fría COMPACTA PIZZA
GN 1/1 PIZZA STATION
- Pag. **78-81** Mesa fría PIZZA cajón neutro
PIZZA counter with neutral drawer
- Pag. **82-83** Mesa fría PIZZA
PIZZA counter
- Pag. **84-85** Expositor ingredientes FAST-FOOD GN
GN FAST-FOOD topping unit



MFP-100 2.560 € MFP-140 3.089 € MFEI70-100 2.528 € MFEI70-140 3.059 €

Incremento precio por cambio de puerta a cajonera doble, sistema autocierre
Door to double drawers set, soft-closing system, increase of price **554 €**



Cubetas GN y perfiles divisorios NO incluidos en el precio, ver página 556
GN containers and dividers NOT included in price, see page 556

mod	rango range °C	largo length (mm)	alto height (mm)	fondo depth (mm)	estantes shelves	pares guías slides sets	volumen capacity (L)	voltaje voltage	refrigerante refrigerant	potencia frig. frig. power W	potencia power W
MFEI70-100	0°C +8°C	925	890	700	2	2	169	230V-50Hz	R290	502	695
MFEI70-140	0°C +8°C	1375	890	700	3	3	264	230V-50Hz	R290	845	369
MFP-100	0°C +8°C	925	890	700	2	2	169	230V-50Hz	R290	502	695
MFP-140	0°C +8°C	1375	890	700	3	3	264	230V-50Hz	R290	845	369

Características técnicas y constructivas sujetas a variación sin previo aviso.

We reserve the right to change specifications without prior notice.

- **MFP** encimera granito, cúpula acristalada sobre alojamientos GN 1/6-100
- **MFEI70-100** encimera inox, cubierta inox abatible sobre expositor ingredientes GN 1/4-150

- **MFP** granite working area and glass cover, GN 1/6-100 capacity
- **MFEI70-100** stainless steel worktop, integrated topping unit with hinged lid, GN 1/4-150 capacity

- Exterior en acero inox AISI-304
- Interior en acero inox AISI-304, con aristas curvas y fondo embutido
- Puertas de apertura reversible, con sistema de cierre automático y burlete magnético (permanece abierta al superar los 90° de apertura)
- Estantes interiores GN 1/1 de alambre en acero plastificado, regulables en altura
- Pies en tubo de acero inox ajustables en altura 95- 135 mm
- Unidad condensadora ventilada y extraíble
- Evaporador sistema tiro forzado, con recubrimiento epoxi anticorrosión
- Evaporación automática del agua de descarche
- Aislamiento de poliuretano inyectado, densidad 40 Kg/m³, cero efectos ODP y GWP
- Control digital de última generación, monitorización en tiempo real, anticipación a incidencias, reducción de averías y simplificación del mantenimiento y uso por APP en smartphone o Tablet
- Temperatura de trabajo a 32°C ambiente

- AISI-304 stainless steel exterior
- AISI-304 stainless steel interior, stamped bottom and rounded corners
- Doors with self closing system, blocked opening, magnetic gasket and possibility of changing the opening sense
- GN 1/1 shelves made of plasticized steel wire, height adjustable
- AISI -304 adjustable legs, 95 to 135 mm
- Removable and fan assisted condenser unit
- Fan assisted evaporator, with epoxi anticorrosion coating.
- Automatic evaporation of defrost water
- 40 Kg/m³ density polyurethane insulation, zero ODP and GWP
- Next-generation digital control, real-time monitoring, issue anticipation, reduced breakdowns, simplified maintenance, and APP-based operation via smartphone or tablet.
- Operating temperature 32°C ambient

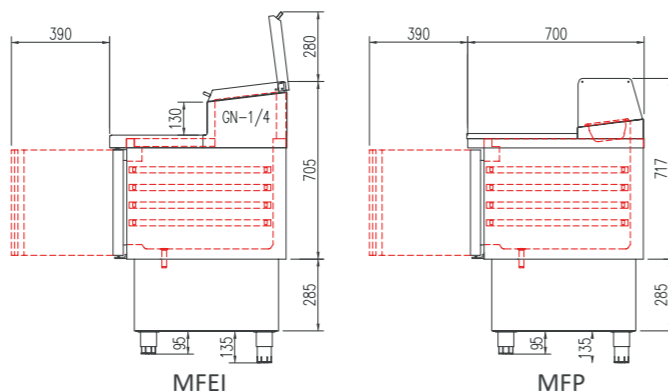

OPCIONES	OPTIONS	€
parrilla adicional GN-1/1	additional shelf GN-1/1	29 €
set adicional guías GN-1/1	additional set GN-1/1 slides	31 €
cerradura puerta inox	SS door lock	31 €
set 4 ruedas	set 4 wheels	112 €
230V 60Hz / 115V 60Hz	230V 60Hz / 115V 60Hz	consultar
APPCC	HACCP	incluido

Encimeras, alojamientos para cubetas y cubiertas, se pueden fabricar a medida.
Worktops, container fits and covers, can be customized.



MFP-140

cerraduras opcionales
locks on demand



evaporador central
double fan evaporator



MFEI70-140

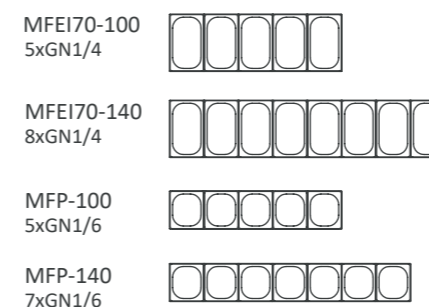



MFS-100 2.423 € MFS-140 2.902 € MFS-100-C 2.391 € MFS-140-C 2.881 €

Incremento precio por cambio de puerta a cajonera doble, sistema autocierre
Door to double drawers set, soft-closing system, increase of price **554 €**



Cubetas GN y perfiles divisorios NO incluidos en el precio, ver página 556
GN containers and dividers NOT included in price, see page 556

mod.	rango range °C	largo length (mm)	alto height (mm)	fondo depth (mm)	perfiles GN GN supports	estantes shelves	paredes guías slides sets	volumen capacity (L)	voltaje voltage	refrigerante refrigerant	potencia frig. frig. power W	potencia power W
MFS-100	0°C +8°C	925	890	700	4	2	2	169	230V-50Hz	R290	502	695
MFS-140	0°C +8°C	1375	890	700	7	3	3	264	230V-50Hz	R290	845	369
MFS-100-C	0°C +8°C	925	890	700	4	2	2	169	230V-50Hz	R290	502	695
MFS-140-C	0°C +8°C	1375	890	700	7	3	3	264	230V-50Hz	R290	845	369

Características técnicas y constructivas sujetas a variación sin previo aviso.

We reserve the right to change specifications without prior notice.

- MFS-C cúpula acristalada sobre alojamiento cubetas
- MFS cubierta inox abatible sobre alojamiento cubetas
- Exterior en acero inox AISI-304
- Interior en acero inox AISI-304, con aristas curvas y fondo embutido
- Puertas de apertura reversible, con sistema de cierre automático y burlete magnético (permanece abierta al superar los 90° de apertura)
- Encimera inox con tabla de polietileno color blanco, deslizante para incrementar superficie de trabajo (otro color, consultar)
- Capacidad cubetas GN en la encimera (ver detalle)
- Estantes interiores GN 1/1 de alambre en acero plastificado, regulables en altura
- Pies en tubo de acero inox ajustables en altura 95- 135 mm
- Unidad condensadora ventilada y extraíble
- Evaporador sistema tiro forzado, con recubrimiento epoxi anticorrosión
- Evaporación automática del agua de descarche
- Aislamiento de poliuretano inyectado, densidad 40 Kg/m³, cero efectos ODP y GWP
- Control digital de última generación, monitorización en tiempo real, anticipación a incidencias, reducción de averías y simplificación del mantenimiento y uso por APP en smartphone o Tablet
- Temperatura de trabajo a 32°C ambiente

- MFS-C glass cover
- MFS hinged lid
- AISI-304 stainless steel exterior
- AISI-304 stainless steel interior, stamped bottom and rounded corners
- Doors with self closing system, blocked opening, magnetic gasket and possibility of changing the opening sense
- AISI-304 stainless steel worktop, with white polyethylene table, sliding to increase work surface (for other color, consult)
- GN containers capacity in the worktop (see detail)
- GN 1/1 shelves made of plasticized steel wire, height adjustable
- AISI -304 adjustable legs, 95 to 135 mm
- Removable and fan assisted condenser unit
- Fan assisted evaporator, with epoxi anticorrosion coating.
- Automatic evaporation of defrost water
- 40 Kg/m³ density polyurethane insulation, zero ODP and GWP
- Next-generation digital control, real-time monitoring, issue anticipation, reduced breakdowns, simplified maintenance, and APP-based operation via smartphone or tablet.
- Operating temperature 32°C ambient

Encimeras, alojamientos para cubetas y cubiertas, se pueden fabricar a medida. Worktops, container fits and covers, can be customized.

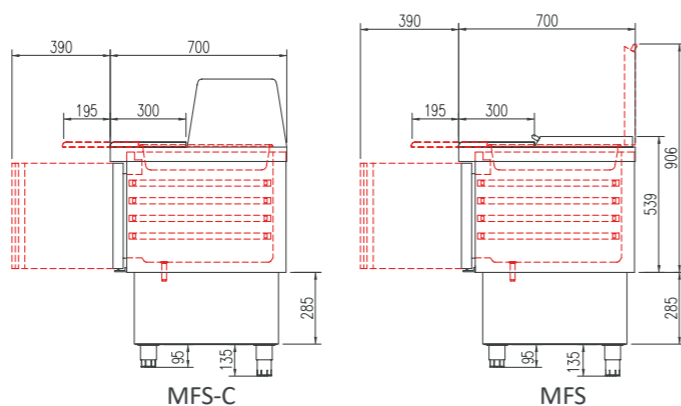

OPCIONES	OPTIONS	€
parrilla adicional GN-1/1	additional shelf GN-1/1	29 €
set adicional guías GN-1/1	additional set GN-1/1 slides	31 €
cerradura puerta inox	SS door lock	31 €
set 4 ruedas	set 4 wheels	112 €
230V 60Hz / 115V 60Hz	230V 60Hz / 115V 60Hz	consultar
APCC	HACCP	incluido

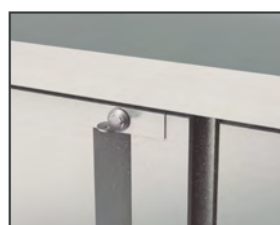

cerraduras opcionales
locks on demand



tabla de corte deslizante
sliding cutting board

MFS-140-C
con cajones (opcional)
with drawers (option)

GN 1/4

MFS-100 / MFS-100-C

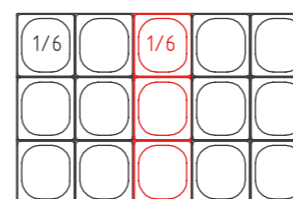

max profundidad: 100 mm - 200 mm
100 mm - 200 mm max depth

MFS-140 / MFS-140-C

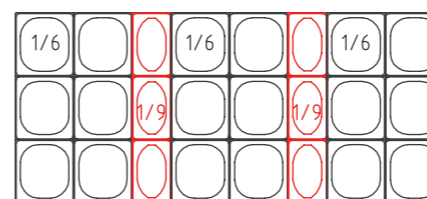

max profundidad: 100 mm - 200 mm
100 mm - 200 mm max depth

ATENCIÓN: la profundidad máxima de las cubetas en el plano de exposición, será 100 mm cuando la mesa incorpore cajones en lugar de puertas.

NOTICE: units with drawers instead of doors, max depth for worktop GN containers must be 100 mm



tabla de corte deslizante
sliding cutting board

MFS-100



MFK-100 2.449 € MFK-140 2.967 € MFK-180 3.858 € MFK-220 5.256 €

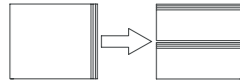

Incremento precio por cambio de puerta a cajonera doble, sistema autocierre
Door to double drawers set, soft-closing system, increase of price

554 €



Cubetas GN y perfiles divisorios NO incluidos en el precio, ver página 556
GN containers and dividers NOT included in price, see page 556

mod.	rango range °C	largo length (mm)	alto height (mm)	fondo depth (mm)	perfiles GN GN supports	estantes shelves	pares guías slides sets	volumen capacity (L)	voltaje voltage	refrigerante refrigerant	potencia frig. frig. power W	potencia power W
MFK-100	0°C +8°C	925	890	700	4	2	2	169	230V-50Hz	R290	502	695
MFK-140	0°C +8°C	1375	890	700	7	3	3	264	230V-50Hz	R290	845	369
MFK-180	0°C +8°C	1825	890	700	9	4	4	345	230V-50Hz	R290	845	369
MFK-220	0°C +8°C	2275	890	700	12	5	5	430	230V-50Hz	R290	1004	431

Características técnicas y constructivas sujetas a variación sin previo aviso.

We reserve the right to change specifications without prior notice.

- Exterior en acero inox AISI-304
- Interior en acero inox AISI-304, con aristas curvas y fondo embutido
- Puertas de apertura reversible, con sistema de cierre automático y burlete magnético (permanece abierta al superar los 90° de apertura)
- Modelos 100 y 140: encimera inox con tabla de polietileno color blanco, deslizante para incrementar superficie de trabajo (otro color, consultar)
- Capacidad cubetas GN en la encimera (ver detalle)
- Cúpula acristalada sobre alojamiento cubetas
- Estantes interiores GN 1/1 de alambre en acero plastificado, regulables en altura
- Pies en tubo de acero inox ajustables en altura 95- 135 mm
- Unidad condensadora ventilada y extraíble
- Evaporador sistema tiro forzado, con recubrimiento epoxi anticorrosión
- Evaporación automática del agua de descharche
- Aislamiento de poliuretano inyectado, densidad 40 Kg/m³, cero efectos ODP y GWP
- Control digital de última generación, monitorización en tiempo real, anticipación a incidencias, reducción de averías y simplificación del mantenimiento y uso por APP en smartphone o Tablet
- Temperatura de trabajo a 32°C ambiente

- AISI-304 stainless steel exterior
- AISI-304 stainless steel interior, stamped bottom and rounded corners
- Doors with self closing system, blocked opening, magnetic gasket and possibility of changing the opening sense
- 100 and 140: AISI-304 stainless steel worktop, with white polyethylene chopping board, sliding to increase work surface (for other color, consult)
- GN capacity in the worktop (see detail)
- Glass cover
- GN 1/1 shelves made of plasticized steel wire, height adjustable
- AISI -304 adjustable legs, 95 to 135 mm
- Removable and fan assisted condenser unit
- Fan assisted evaporator, with epoxi anticorrosion coating.
- Automatic evaporation of defrost water
- 40 Kg/m³ density polyurethane insulation, zero ODP and GWP
- Next-generation digital control, real-time monitoring, issue anticipation, reduced breakdowns, simplified maintenance, and APP-based operation via smartphone or tablet.
- Operating temperature, 32°C ambient

Encimeras, alojamientos para cubetas y cubiertas, se pueden fabricar a medida.
Worktops, container fits and covers, can be customized.



evaporador central
double fan evaporator

cajones opcionales
optional drawers

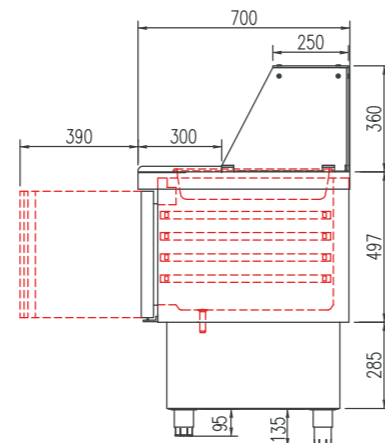

OPCIONES	OPTIONS	€
parrilla adicional GN-1/1	additional shelf GN-1/1	29 €
set adicional guías GN-1/1	additional set GN-1/1 slides	31 €
cerradura puerta inox	SS door lock	31 €
set 4 ruedas	set 4 wheels	112 €
230V 60Hz / 115V 60Hz	230V 60Hz / 115V 60Hz	consultar
APCC	HACCP	incluido



MFK-220

cerraduras opcionales
locks on demand



MFK-100

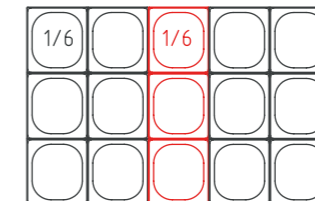

MFK-140

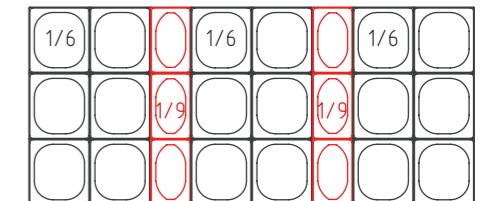

MFK-180

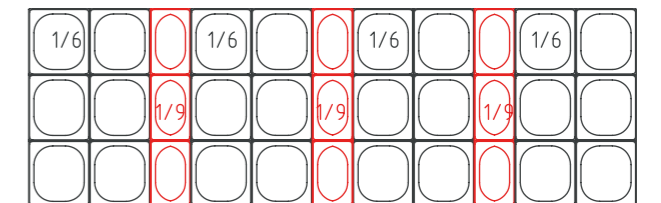

MFK-220

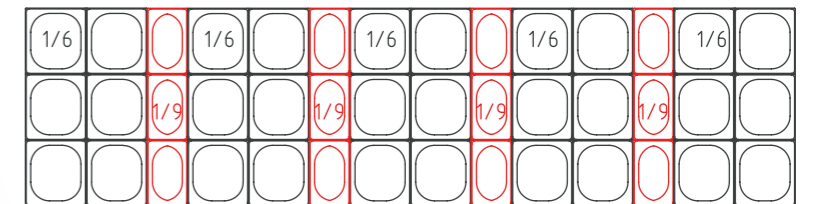

ATENCIÓN: la profundidad máxima de las cubetas en el plano de exposición, será 100 mm cuando la mesa incorpore cajones en lugar de puertas.

NOTICE: units with drawers instead of doors, max depth for worktop GN containers must be 100 mm



MFK70-135 3.387 €



MFK70-180 4.127 €



MFK70-180



MFK70-180
Vista trasera
Back side view

	Incremento precio por cambio de puerta a cajonera doble , desmontable sobre guías inox telescópicas, sistema auto-cierre	Increase of price by changing door to double drawers set, detachable telescopic SS runners, soft-closing system	648 €
--	---	---	-------



Cubetas GN y perfiles divisorios NO incluidos en el precio, ver página 556
GN containers and dividers NOT included in price, see page 556

mod.	rango range °C	largo length (mm)	alto height (mm)	fondo depth (mm)	estantes shelves	pares guías slides sets	volumen capacity (L)	voltaje voltage	refrigerante refrigerant	potencia frig. frig. power W	potencia power W
MFK70-135	0°C +8°C	1345	850	700	2	2	255	230V-50Hz	R290	502	695
MFK70-180	0°C +8°C	1795	850	700	3	3	399	230V-50Hz	R290	845	369

Características técnicas y constructivas sujetas a variación sin previo aviso.

We reserve the right to change specifications without prior notice.

- Exterior en acero inox AISI-304
- Interior en acero inox AISI-304, con aristas curvas y fondo embutido
- Puertas de apertura reversible, con sistema de cierre automático y burlete magnético (permanece abierta al superar los 90° de apertura)
- Contrapuerta inox embutida
- Encimera inox con capacidad cubetas GN 1/3-100 (ver detalle)
- Cúpula acristalada sobre alojamiento cubetas, con estante intermedio
- Estantes interiores de alambre en acero plastificado, regulables en altura, sobre guías de acero inox
- Pies en tubo de acero inox ajustables en altura 135- 210 mm
- Unidad condensadora ventilada y extraíble
- Evaporador sistema tiro forzado, con recubrimiento epoxi anticorrosión
- Evaporación automática del agua de descarche
- Aislamiento de poliuretano inyectado, densidad 40 Kg/m³, cero efectos ODP y GWP
- Control digital de última generación, monitorización en tiempo real, anticipación a incidencias, reducción de averías y simplificación del mantenimiento y uso por APP en smartphone o Tablet
- Temperatura de trabajo a 32°C ambiente

- AISI-304 stainless steel exterior
- AISI-304 stainless steel interior, stamped bottom and rounded corners
- Doors with self closing system, blocked opening, magnetic gasket and possibility of changing the opening sense
- Inner side of doors by stamped steel
- AISI-304 stainless steel worktop, capacity for GN-1/3-100 containers (see detail)
- Glass cover with shelf
- Shelves made of plasticized steel wire, height adjustable by stainless steel slides
- AISI -304 adjustable legs, 135 to 210 mm
- Removable and fan assisted condenser unit
- Fan assisted evaporator, with epoxi anticorrosion coating.
- Automatic evaporation of defrost water
- 40 Kg/m³ density polyurethane insulation, zero ODP and GWP
- Next-generation digital control, real-time monitoring, issue anticipation, reduced breakdowns, simplified maintenance, and APP-based operation via smartphone or tablet.
- Operating temperature, 32°C ambient

MFK70-135

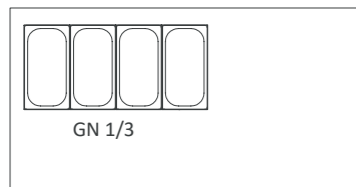

MFK70-180

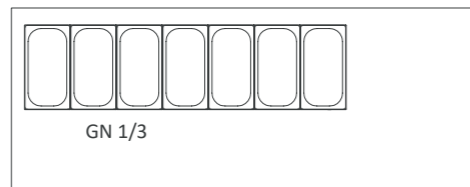

ATENCIÓN: la profundidad máxima de las cubetas en el plano de exposición, será 100 mm cuando la mesa incorpore cajones en lugar de puertas.

NOTICE: units with drawers instead of doors, max depth for worktop GN containers must be 100 mm

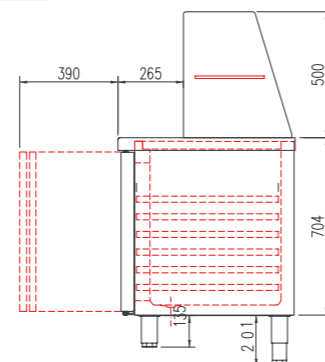

OPCIONES	OPTIONS	€
perfil adicional GN-divisorio encimera	additional GN-divider profile for worktop	13 €
parrilla adicional GN-1/1	additional shelf GN-1/1	29 €
set adicional guías GN-1/1	additional set GN-1/1 slides	31 €
motor lado izquierdo	left side motor	77 €
cerradura puerta inox	SS door lock	31 €
set 4 ruedas	set 4 wheels	112 €
set 6 ruedas	set 6 wheels	166 €
230V 60Hz / 115V 60Hz	230V 60Hz / 115V 60Hz	consultar
APCC	HACCP	incluido

Encimeras, alojamientos para cubetas y cubiertas, se pueden fabricar a medida.
Worktops, container fits and covers, can be customized.

cerraduras opcionales
locks on demand



ruedas opcionales
castors on demand



cajones opcionales
drawers on demand



evaporador central
double fan evaporator





PC80-150-15-LGL 4.689 €



PC80-200-27-LGL 5.619 €



Cubetas GN y perfiles divisorios NO incluidos en el precio, ver página 556
GN containers and dividers NOT included in price, see page 556

mod.	rango range °C	largo length (mm)	alto height (mm)	fondo depth (mm)	perfiles GN GN supports	estantes shelves	pares guías slides sets	capacidad GN GN capacity 1/6	volumen capacity (L)	voltaje voltage	refrigerante refrigerant	potencia frig. frig. power W	potencia power W
PC80-150-15	0°C +8°C	1495	870	800	4	2	2	15	362	230V-50Hz	R290	502	703
PC80-200-27	0°C +8°C	2020	870	800	8	3	3	27	562	230V-50Hz	R290	845	382

Características técnicas y constructivas sujetas a variación sin previo aviso.

- Exterior en acero inox AISI-304, incluido el respaldo
- Interior en acero inox AISI-304, con aristas curvas y fondo embutido
- Puertas de apertura reversible, con sistema de cierre automático y burlete magnético (permanece abierta al superar los 90° de apertura)
- Contrapuerta inox embutida
- Encimera inox con capacidad cubetas GN (ver detalle)
 - Tabla de corte en polietileno
 - Perfiles divisorios fijos (desmontable para limpieza) para apoyo de las cubetas
- Robusta estructura elevable, con doble cristal para mantener la temperatura del área de cubetas
- Máxima visibilidad del producto, LED 6500 K
- Opción LED 3000 K (luz cálida) o Rosa al mismo precio
- Sellado del perímetro de la cubierta por burletes
- Sistema de pistones y amortiguadores para compensar el peso
- Estantes interiores de alambre en acero plastificado, regulables en altura, sobre guías de acero inox
- Pies en tubo de acero inox ajustables en altura 135- 210 mm
- Unidad condensadora ventilada y extraíble
- Evaporador sistema tiro forzado, con recubrimiento epoxi anticorrosión
- Evaporación automática del agua de descarche
- Aislamiento de poliuretano inyectado, densidad 40 Kg/m³, cero efectos ODP y GWP
- Control digital de última generación, monitorización en tiempo real, anticipación a incidencias, reducción de averías y simplificación del mantenimiento y uso por APP en smartphone o Tablet
- Temperatura de trabajo a 32°C ambiente

We reserve the right to change specifications without prior notice.

- AISI-304 stainless steel exterior, rear side included
- AISI-304 stainless steel interior, stamped bottom and rounded corners
- Doors with self closing system, blocked opening, magnetic gasket and possibility of changing the opening sense
- Inner side of doors by stamped steel
- AISI-304 worktop, capacity for GN containers (see detail)
 - Polyethylene cutting table
 - Fixed pan dividers (detachable for cleaning)
- Heavy-duty double liftable glass lid to keep temperature in the GN pans
- Maximum product visibility by 6500 K LED
- Optional 3000 K LED (soft light) or Pink, same price
- Perimetral gasket around the lid structure
- Piston system to help the opening /closing of the structure
- Shelves made of plasticized steel wire, height adjustable by stainless steel slides
- AISI -304 adjustable legs, 135 to 210 mm
- Removable and fan assisted condenser unit
- Fan assisted evaporator, with epoxi anticorrosion coating.
- Automatic evaporation of defrost water
- 40 Kg/m³ density polyurethane insulation, zero ODP and GWP
- Next-generation digital control, real-time monitoring, issue anticipation, reduced breakdowns, simplified maintenance, and APP-based operation via smartphone or tablet.
- Operating temperature 32°C ambient

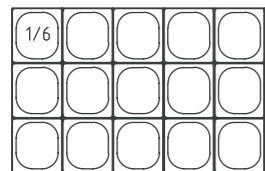

PC80-150-15-LGL

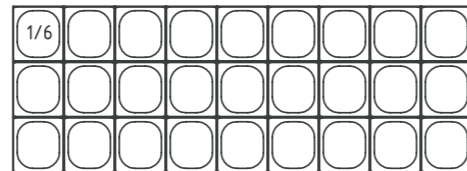

PC80-200-27-LGL



OPCIONES	OPTIONS	€
parrilla 60x40	shelf 60x40	29 €
set adicional guías 60x40	additional set slides 60x40	25 €
cerradura puerta inox	SS door lock	31 €
set 4 ruedas	set 4 wheels	112 €
set 6 ruedas	set 6 wheels	166 €
230V 60Hz / 115V 60Hz	230V 60Hz / 115V 60Hz	consultar
APPCC	HACCP	incluido



PC80-200-27-LGL



PC80-200-27-LGL

cerraduras opcionales
locks on demand



ruedas opcionales
castors on demand



cajones opcionales
drawers on demand



evaporador central
double fan evaporator





MFE-150 3.323 €



MFE-200 3.985 €

Incremento precio por cambio de puerta a cajonera **doble**, desmontable sobre guías inox telescópicas, sistema auto-cierre *Increase of price by changing door to double drawers set, detachable telescopic SS runners, soft-closing system* 648 €



Cubetas GN y perfiles divisorios **NO** incluidos en el precio, ver página 556
GN containers and dividers **NOT** included in price, see page 556

mod.	rango range °C	largo length (mm)	alto height (mm)	fondo depth (mm)	perfiles GN GN supports	estantes shelves	pares guías slides sets	volumen capacity (L)	voltaje voltage	refrigerante refrigerant	potencia frig. frig. power W	potencia power W
MFE-150	0°C +8°C	1345	850	700	4	2	2	255	230V-50Hz	R290	502	725
MFE-200	0°C +8°C	1795	850	700	6	3	3	399	230V-50Hz	R290	845	369

Características técnicas y constructivas sujetas a variación sin previo aviso.

We reserve the right to change specifications without prior notice.

- Exterior en acero inox AISI-304, excepto el respaldo y fondo
- Interior en acero inox AISI-304, con aristas curvas y fondo embutido
- Puertas de apertura reversible, con sistema de cierre automático y burlete magnético (permanece abierta al superar los 90° de apertura)
- Contrapuerta inox embutida
- Encimera inox con capacidad cubetas GN (ver detalle) y cubierta inox abatible y plegable
- Estantes interiores de alambre en acero plastificado, regulables en altura, sobre guías de acero inox
- Pies en tubo de acero inox ajustables en altura 135- 210 mm
- Unidad condensadora ventilada y extraíble
- Evaporador sistema tiro forzado, con recubrimiento epoxi anticorrosión
- Evaporación automática del agua de descarche
- Aislamiento de poliuretano inyectado, densidad 40 Kg/m³, cero efectos ODP y GWP
- Control digital de última generación, monitorización en tiempo real, anticipación a incidencias, reducción de averías y simplificación del mantenimiento y uso por APP en smartphone o Tablet
- Temperatura de trabajo a 32°C ambiente

- AISI-304 stainless steel exterior, except rear side and base
- AISI-304 stainless steel interior, stamped bottom and rounded corners
- Doors with self closing system, blocked opening, magnetic gasket and possibility of changing the opening sense
- Inner side of doors by stamped steel
- AISI-304 stainless steel worktop, capacity for GN containers (see detail) with hinged stainless steel lid
- Shelves made of plasticized steel wire, height adjustable by stainless steel slides
- AISI -304 adjustable legs, 135 to 210 mm
- Removable and fan assisted condenser unit
- Fan assisted evaporator, with epoxi anticorrosion coating.
- Automatic evaporation of defrost water
- 40 Kg/m³ density polyurethane insulation, zero ODP and GWP
- Digital temperature control, optimized defrost, high-temperature con-
- Next-generation digital control, real-time monitoring, issue anticipation, reduced breakdowns, simplified maintenance, and APP-based operation via smartphone or tablet.
- Operating temperature 32°C ambient

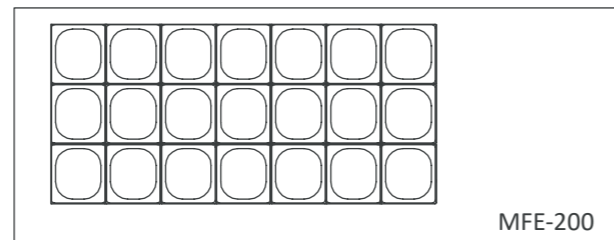
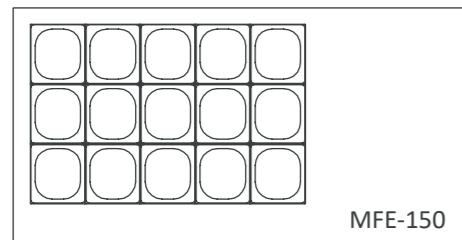

ATENCIÓN: la profundidad máxima de las cubetas en el plano de exposición, sera 100 mm cuando la mesa incorpore cajones en lugar de puertas.

NOTICE: units with drawers instead of doors, max depth for worktop GN containers must be 100 mm

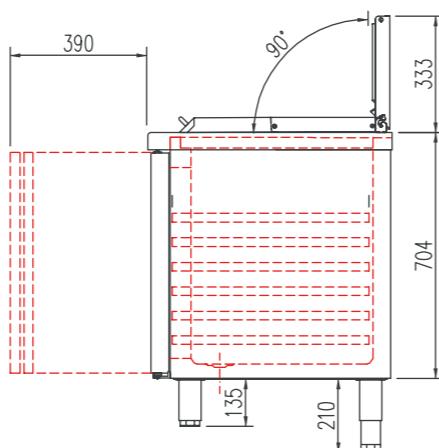

OPCIONES	OPTIONS	€
perfil adicional GN-divisorio encimera	additional GN-divider profile for worktop	13 €
parrilla adicional GN-1/1	additional shelf GN-1/1	29 €
set adicional guías GN-1/1	additional set GN-1/1 slided	31 €
cerradura puerta inox	SS door lock	31 €
motor lado izquierdo	left side motor	76 €
set 4 ruedas	set 4 wheels	112 €
set 6 ruedas	set 6 wheels	166 €
230V 60Hz / 115V 60Hz	230V 60Hz / 115V 60Hz	consultar
APPCC	HACCP	incluido

Encimeras, alojamientos para cubetas y cubiertas, se pueden fabricar a medida. Worktops, container fits and covers, can be customized.



cerraduras opcionales
locks on demand



ruedas opcionales
castors on demand



cajones opcionales
drawers on demand



evaporador central
double fan evaporator





MFEI60-150	3.294 €	MFEI60-200	3.879 €	MFEI70-225	4.723 €	MFEI70-270	5.897 €
MFEI70-135	3.458 €	MFEI70-180	4.113 €				

	Incremento precio por cambio de puerta a cajonera doble , desmontable sobre guías inox telescópicas, sistema auto-cierre	Increase of price by changing door to double drawers set, detachable telescopic SS runners, soft-closing system	Gama 60	Gama 70
			515 €	648 €



Cubetas GN y perfiles divisorios NO incluidos en el precio, ver página 556
GN containers and dividers NOT included in price, see page 556

mod.	rango range °C	largo length (mm)	alto height (mm)	fondo depth (mm)	estantes shelves	pares guías slides sets	capacidad GN GN capacity 1/4	volumen capacity (L)	voltaje voltage	refrigerante refrigerant	potencia frig. frig. power W	potencia power W
MFEI60-150	0°C +8°C	1495	850	600	2	0	8	245	230V-50Hz	R290	502	725
MFEI60-200	0°C +8°C	2020	850	600	3	0	12	380	230V-50Hz	R290	845	369
MFEI70-135	0°C +8°C	1345	850	700	2	2	8	255	230V-50Hz	R290	502	725
MFEI70-180	0°C +8°C	1795	850	700	3	3	10	399	230V-50Hz	R290	845	369
MFEI70-225	0°C +8°C	2245	850	700	4	4	13	543	230V-50Hz	R290	845	369
MFEI70-270	0°C +8°C	2695	850	700	5	5	16	686	230V-50Hz	R290	1004	431

Características técnicas y constructivas sujetas a variación sin previo aviso.

We reserve the right to change specifications without prior notice.

- **MFEI60** estantes interiores de alambre en acero plastificado, regulables en altura, sobre apoyos inox
- **MFEI70** estantes interiores GN 1/1 de alambre en acero plastificado, sobre guías de acero inox regulables en altura
- Exterior en acero inox AISI-304, excepto el respaldo y fondo
- Interior en acero inox AISI-304, con aristas curvas y fondo embutido
- Puertas de apertura reversible, con sistema de cierre automático y burlete magnético (permanece abierta al superar los 90° de apertura)
- Contrapuerta inox embutida
- Encimera inox con expositor de ingredientes integrado y cubierta inox abatible
- Expositor ingredientes GN 1/4-150
- Pies en tubo de acero inox ajustables en altura 135- 210 mm
- Unidad condensadora ventilada y extraíble
- Evaporador sistema tiro forzado, con recubrimiento epoxi anticorrosión
- Evaporación automática del agua de descarche
- Aislamiento de poliuretano inyectado, densidad 40 Kg/m³, cero efectos ODP y GWP
- Control digital de última generación, monitorización en tiempo real, anticipación a incidencias, reducción de averías y simplificación del mantenimiento y uso por APP en smartphone o Tablet
- Temperatura de trabajo a 32°C ambiente

- **MFEI60** shelves made of plasticized steel wire, height adjustable
- **MFEI70** GN 1/1 shelves made of plasticized steel wire, height adjustable
- AISI-304 stainless steel exterior, except rear side and base
- AISI-304 stainless steel interior, stamped bottom and rounded corners
- Doors with self closing system, blocked opening, magnetic gasket and possibility of changing the opening sense
- Inner side of doors by stamped steel
- Stainless steel worktop, integrated topping unit withinged lid,
- GN 1/4-150 topping unit
- AISI -304 adjustable legs, 135 to 210 mm
- Removable and fan assisted condenser unit
- Fan assisted evaporator, with epoxi anticorrosion coating.
- Automatic evaporation of defrost water
- 40 Kg/m³ density polyurethane insulation, zero ODP and GWP
- Next-generation digital control, real-time monitoring, issue anticipation, reduced breakdowns, simplified maintenance, and APP-based operation via smartphone or tablet.
- Operating temperature, 32°C ambient

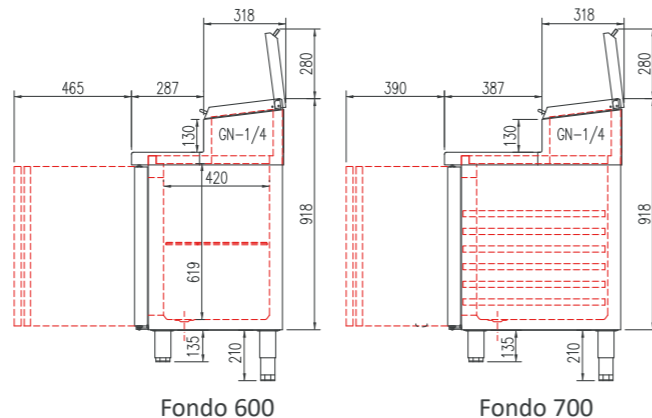

Fondo 600

Fondo 700

cerraduras opcionales
locks on demand

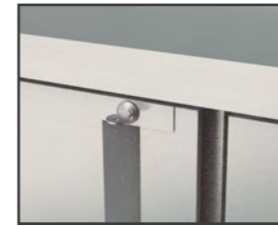

ruedas opcionales
castors on demand



cajones opcionales
drawers on demand



evaporador central
double fan evaporator



MFEI70-180



OPCIONES	OPTIONS	€
parrilla adicional GN-1/1	additional shelf GN-1/1	29 €
set adicional guías GN-1/1	additional set GN-1/1 slides	31 €
cerradura puerta inox	SS door lock	31 €
motor lado izquierdo	left side motor	77 €
set 4 ruedas	set 4 wheels	112 €
set 6 ruedas	set 6 wheels	166 €
230V 60Hz / 115V 60Hz	230V 60Hz / 115V 60Hz	consultar
APPC	HACCP	incluido

Encimeras, alojamientos para cubetas y cubiertas, se pueden fabricar a medida.
Worktops, container fits and covers, can be customized.





MFEI70-180-1/6 4.113 €

MFEI70-225-1/6 4.851 €

MFEI70-270-1/6 6.037 €

cerraduras opcionales
locks on demand

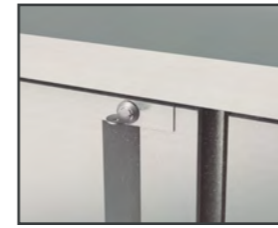

ruedas opcionales
castors on demand



cajones opcionales
drawers on demand



evaporador central
double fan evaporator



	Incremento precio por cambio de puerta a cajonera doble , desmontable sobre guías inox telescópicas, sistema auto-cierre	Increase of price by changing door to double drawers set, detachable telescopic SS runners, soft-closing system	648 €
--	---	---	-------



Cubetas GN y perfiles divisorios NO incluidos en el precio, ver página 556
GN containers and dividers NOT included in price, see page 556

mod.	rango range °C	largo length (mm)	alto height (mm)	fondo depth (mm)	estantes shelves	pares guías slides sets	capacidad GN GN capacity 1/6	volumen capacity (L)	voltaje voltage	refrigerante refrigerant	potencia frig. frig. power W	potencia power W
MFEI70-180-1/6	0°C +8°C	1795	850	700	3	3	10	399	230V-50Hz	R290	845	369
MFEI70-225-1/6	0°C +8°C	2245	850	700	4	4	13	543	230V-50Hz	R290	845	369
MFEI70-270-1/6	0°C +8°C	2695	850	700	5	5	16	686	230V-50Hz	R290	1004	431

Características técnicas y constructivas sujetas a variación sin previo aviso.

We reserve the right to change specifications without prior notice.

- Exterior en acero inox AISI-304, excepto el respaldo y fondo
- Interior en acero inox AISI-304, con aristas curvas y fondo embutido
- Puertas de apertura reversible, con sistema de cierre automático y burlete magnético (permanece abierta al superar los 90° de apertura)
- Contrapuerta inox embutida
- Encimera inox con expositor de ingredientes integrado y cubierta inox abatible
- Expositor ingredientes GN 1/6-150
- Estantes interiores GN 1/1 de alambre en acero plastificado, sobre guías de acero inox regulables en altura
- Pies en tubo de acero inox ajustables en altura 135- 210 mm
- Unidad condensadora ventilada y extraíble
- Evaporador sistema tiro forzado, con recubrimiento epoxi anticorrosión
- Evaporación automática del agua de descarche
- Aislamiento de poliuretano inyectado, densidad 40 Kg/m³, cero efectos ODP y GWP
- Control digital de última generación, monitorización en tiempo real, anticipación a incidencias, reducción de averías y simplificación del mantenimiento y uso por APP en smartphone o Tablet
- Temperatura de trabajo a 32°C ambiente

- AISI-304 stainless steel exterior, except rear side and base
- AISI-304 stainless steel interior, stamped bottom and rounded corners
- Doors with self closing system, blocked opening, magnetic gasket and possibility of changing the opening sense
- Inner side of doors by stamped steel
- AISI-304 stainless steel worktop, raised topping well with hinged lid
- GN 1/4-150 topping unit
- GN 1/1 shelves made of plasticized steel wire, height adjustable
- AISI -304 adjustable legs, 135 to 210 mm
- Removable and fan assisted condenser unit
- Fan assisted evaporator, with epoxi anticorrosion coating.
- Automatic evaporation of defrost water
- 40 Kg/m³ density polyurethane insulation, zero ODP and GWP
- Next-generation digital control, real-time monitoring, issue anticipation, reduced breakdowns, simplified maintenance, and APP-based operation via smartphone or tablet.
- Operating temperature, 32°C ambient

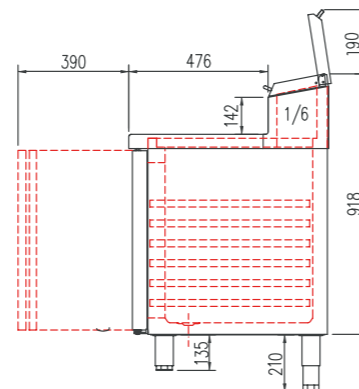

OPCIONES	OPTIONS	€
parrilla adicional GN-1/1	additional shel GN-1/1	29 €
set adicional guías GN-1/1	additional set GN-1/1 slides	31 €
cajonera doble inox, auto-cierre	double SS drawer, self-closing	648 €
cerradura puerta inox	SS door lock	31 €
motor lado izquierdo	left side motor	77 €
set 4 ruedas	set 4 wheels	112 €
set 6 ruedas	set 6 wheels	166 €
230V 60Hz / 115V 60Hz	230V 60Hz / 115V 60Hz	consultar
APPCC	HACCP	incluido

Encimeras, alojamientos para cubetas y cubiertas, se pueden fabricar a medida.
Worktops, container fits and covers, can be customized.



MFEI70-225-1/6
cajones refrigerados opcionales
optional drawers

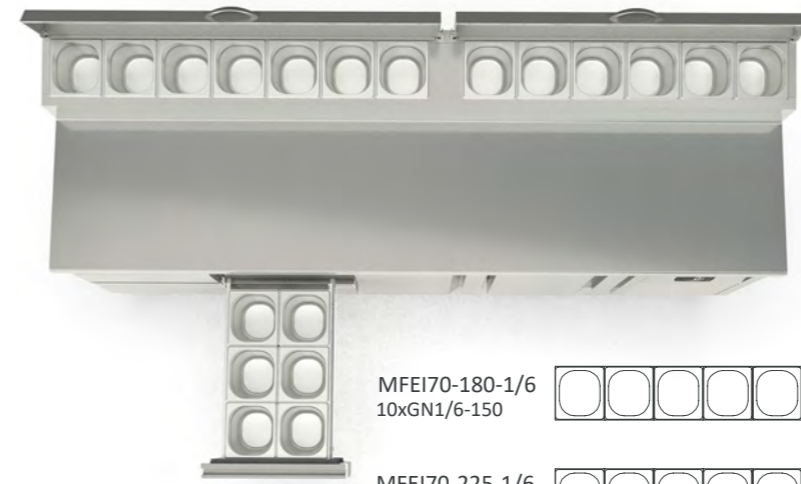

MFEI70-180-1/6
10xGN1/6-150



MFEI70-225-1/6
13xGN1/6-150



MFEI70-270-1/6
16xGN1/6-150





MFEI80-150 3.941 €



MFEI80-200 4.553 €



MFEI80-250 5.237 €



Cubetas GN y perfiles divisorios NO incluidos en el precio, ver página 556
GN containers and dividers NOT included in price, see page 556

mod.	rango range °C	largo length (mm)	alto height (mm)	fondo depth (mm)	estantes shelves	pares guías slides sets	capacidad GN GN capacity 1/3	volumen capacity (L)	voltaje voltage	refrigerante refrigerant	potencia frig. frig. power W	potencia power W
MFEI80-150	0°C +8°C	1495	850	800	2	2	8	362	230V-50Hz	R290	502	725
MFEI80-200	0°C +8°C	2020	850	800	3	3	10	562	230V-50Hz	R290	845	369
MFEI80-250	0°C +8°C	2545	850	800	4	4	13	761	230V-50Hz	R290	845	369

Características técnicas y constructivas sujetas a variación sin previo aviso.

We reserve the right to change specifications without prior notice.

- Exterior en acero inox AISI-304, excepto el respaldo y fondo
- Interior en acero inox AISI-304, con aristas curvas y fondo embutido
- Puertas de apertura reversible, con sistema de cierre automático y burlete magnético (permanece abierta al superar los 90° de apertura)
- Contrapuerta inox embutida
- Encimera inox con expositor de ingredientes integrado y cubierta inox abatible
- Expositor ingredientes GN 1/3-150
- Estantes interiores 60x40 de alambre en acero plastificado, sobre guías de acero inox regulables en altura
- Pies en tubo de acero inox ajustables en altura 135- 210 mm
- Unidad condensadora ventilada y extraíble
- Evaporador sistema tiro forzado, con recubrimiento epoxi anticorrosión
- Evaporación automática del agua de descarche
- Aislamiento de poliuretano inyectado, densidad 40 Kg/m³, cero efectos ODP y GWP
- Control digital de última generación, monitorización en tiempo real, anticipación a incidencias, reducción de averías y simplificación del mantenimiento y uso por APP en smartphone o Tablet
- Temperatura de trabajo a 32°C ambiente
- OPCIONAL: parrilla de trabajo 495x425 con bandeja recogedora

- AISI-304 stainless steel exterior, except rear side and base
- AISI-304 stainless steel interior, stamped bottom and rounded corners
- Doors with self closing system, blocked opening, magnetic gasket and possibility of changing the opening sense
- Inner side of doors by stamped steel
- Stainless steel worktop, integrated topping unit withhinged lid, GN 1/3-100 capacity
- GN 1/3-150 topping unit
- Capacity for 60x40 shelves, containers or trays by stainless steel slides, height adjustable
- AISI -304 adjustable legs, 135 to 210 mm
- Removable and fan assisted condenser unit
- Fan assisted evaporator, with epoxi anticorrosion coating.
- Automatic evaporation of defrost water
- 40 Kg/m³ density polyurethane insulation, zero ODP and GWP
- Next-generation digital control, real-time monitoring, issue anticipation, reduced breakdowns, simplified maintenance, and APP-based operation via smartphone or tablet.
- Operating temperature, 32°C ambient
- OPTIONAL: 525x400 working grill with drip pan



OPCIONES	OPTIONS	€
parrilla + bandeja trabajo 495x425	rack + work tray 495x425	203 €
cerradura puerta inox	SS door lock	31 €
motor lado izquierdo	left side motor	77 €
set 4 ruedas	set 4 wheels	112 €
set 6 ruedas	set 6 wheels	166 €
APPCC	HACCP	incluido
encimera de granito	granite countertop	consultar
respaldo inox	SS rear side	consultar
230V 60Hz / 115V 60Hz	230V 60Hz / 115V 60Hz	consultar

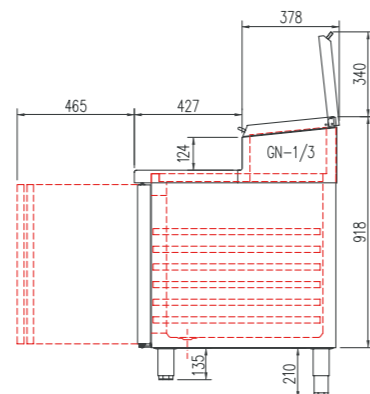

Encimeras, alojamientos para cubetas y cubiertas, se pueden fabricar a medida.
Worktops, container fits and covers, can be customized.



MFEI80-200
bandeja y parrilla de trabajo, opcionales
with working grills and trays, optional



MFEI80
encimera granito opcional y estantes extra
optional granite worktop and extra shelves

cerraduras opcionales
locks on demand

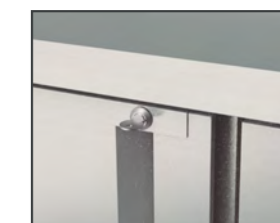

evaporador central
double fan evaporator



ruedas opcionales
castors on demand





MFP-140 4.054 €



MFCP-140 4.795 €

El precio incluye vitrina de ingredientes - Topping unit included in price



Cubetas GN y perfiles divisorios NO incluidos en el precio, ver página 556
GN containers and dividers NOT included in price, see page 556

mod.	rango range °C	largo length (mm)	alto height (mm)	fondo depth (mm)	estantes shelves	pares guías slides sets	capacidad GN GN capacity 1/4	volumen capacity (L)	voltaje voltage	refrigerante refrigerant	potencia frig. frig. power W	potencia power W
MFP-140	0°C +8°C	1370	890	700	3	3	5	264	230V-50Hz	R290	845	369
MFCP-140	0°C +8°C	1370	970	700	3	3	5	399	230V-50Hz	R290	845	369

Características técnicas y constructivas sujetas a variación sin previo aviso.

We reserve the right to change specifications without prior notice.

- Exterior en acero inox AISI-304
- Interior en acero inox AISI-304, con aristas curvas y fondo embutido
- Puertas de apertura reversible, con sistema de cierre automático y burlete magnético (permanece abierta al superar los 90° de apertura)
- Encimera de granito, con peto trasero y laterales de 180 mm
- Estantes interiores GN 1/1 de alambre en acero plastificado, regulables en altura
- Unidad condensadora ventilada y extraíble
- Evaporador sistema tiro forzado, con recubrimiento epoxi anticorrosión
- Evaporación automática del agua de descarche
- Aislamiento de poliuretano inyectado, densidad 40 Kg/m³, cero efectos ODP y GWP
- Control digital de última generación, monitorización en tiempo real, anticipación a incidencias, reducción de averías y simplificación del mantenimiento y uso por APP en smartphone o Tablet
- Expositor de ingredientes independiente, capacidad GN 1/4, incluido
- Temperatura de trabajo 32°C ambiente

- AISI-304 stainless steel exterior
- AISI-304 stainless steel interior, stamped bottom and rounded corners
- Doors with self closing system, blocked opening, magnetic gasket and possibility of changing the opening sense
- Granite working surface with 180 mm upstands
- GN 1/1 shelves made of plasticized steel wire, height adjustable
- Removable and fan assisted condenser unit
- Fan assisted evaporator, with epoxi anticorrosion coating.
- Automatic evaporation of defrost water
- 40 Kg/m³ density polyurethane insulation, zero ODP and GWP
- Next-generation digital control, real-time monitoring, issue anticipation, reduced breakdowns, simplified maintenance, and APP-based operation via smartphone or tablet.
- GN 1/4 topping unit, included
- Operating temperature 32°C ambient



MFCP-140

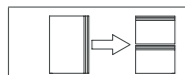

Incremento precio por cambio de puerta a cajonera **doble**, desmontable sobre guías inox telescópicas, sistema auto-cierre

Increase of price by changing door to double drawers set, detachable telescopic SS runners, soft-closing system

MFP	MFCP
554 €	648 €



evaporador central double fan evaporator

cajones opcionales optional drawers

OPCIONES	OPTIONS	€
parrilla adicional GN-1/1	additional shelf GN-1/1	29 €
set adicional guías GN-1/1	additional set GN-1/1 slides	31 €
set 4 ruedas	set 4 wheels	112 €
cerradura puerta inox	SS door lock	31 €
APPCC	HACCP	incluido
230V 60Hz / 115V 60Hz	230V 60Hz / 115V 60Hz	consultar
sin expositor de ingredientes	without ingredient display	consultar



Expositor topping con iluminación LED LED lighting topping unit

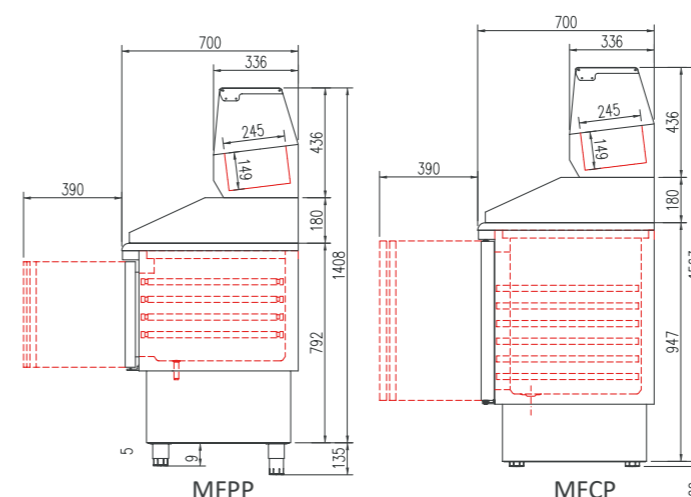



MR80-160 4.810 €



MR80-210 5.619 €



MR80-265 6.444 €

El precio incluye vitrina de ingredientes - Topping unit included in price



Cubetas GN y perfiles divisorios NO incluidos en el precio, ver página 556
GN containers and dividers NOT included in price, see page 556

mod.	rango range °C	largo length (mm)	alto height (mm)	fondo depth (mm)	estantes shelves	pares guías slides sets	cajas neutras neutral containers	cajas refrigeradas refrigerated containers	volumen capacity (L)	voltaje voltage	refrigerante refrigerant	potencia frig. frig. power W	potencia power W
MR80-160	0°C +8°C	1565	850	800	0	8	3	3	362	230V-50Hz	R290	502	187
MR80-210	0°C +8°C	2090	850	800	0	13	3	3	562	230V-50Hz	R290	502	190
MR80-265	0°C +8°C	2615	850	800	0	18	3	3	761	230V-50Hz	R290	845	305

Características técnicas y constructivas sujetas a variación sin previo aviso.

We reserve the right to change specifications without prior notice.

- Exterior en acero inox AISI-304, excepto el respaldo y fondo
- Interior en acero inox AISI-304, con aristas curvas
- Puertas de apertura reversible, con sistema de cierre automático y burlete magnético (permanece abierta al superar los 90° de apertura)
- Contrapuerta inox embutida
- Encimera de granito, con peto trasero y laterales de 180 mm
- Interior con guías de acero inox, regulables en altura para parrillas, bandejas o contenedores 60x40x7 (4 en dotación)
- Cajón neutro con 3 contenedores 60x40x7 en dotación
- Pies en tubo de acero inox ajustables en altura 135- 210 mm
- Unidad condensadora ventilada y extraíble
- Evaporador sistema tiro forzado, con recubrimiento epoxi anticorrosión
- Evaporación automática del agua de descarche
- Aislamiento de poliuretano inyectado, densidad 40 Kg/m³, cero efectos ODP y GWP
- Control digital de última generación, monitorización en tiempo real, anticipación a incidencias, reducción de averías y simplificación del mantenimiento y uso por APP en smartphone o Tablet
- Expositor de ingredientes independiente, capacidad GN 1/4, incluido
- Temperatura de trabajo e 32°C ambiente

- AISI-304 stainless steel exterior, except rear side and base
- AISI-304 stainless steel interior, stamped bottom and rounded corners
- Doors with self closing system, blocked opening, magnetic gasket and possibility of changing the opening sense
- Inner side of doors by stamped steel
- Granite working surface with 180 mm upstands
- interior with stainless steel slides, height adjustable, capacity for 60x40 shelves, trays or containers (4 as standard)
- Neutral drawer with three 60x40x7 containers as standard
- AISI -304 adjustable legs, 135 to 210 mm
- Removable and fan assisted condenser unit
- Fan assisted evaporator, with epoxi anticorrosion coating.
- Automatic evaporation of defrost water
- 40 Kg/m³ density polyurethane insulation, zero ODP and GWP
- Next-generation digital control, real-time monitoring, issue anticipation, reduced breakdowns, simplified maintenance, and APP-based operation via smartphone or tablet.
- GN 1/4 topping unit, included
- Operating temperature 32°C ambient



MR80-210

60x40

OPCIONES	OPTIONS	€
parrilla 60x40	grill 60x40	29 €
cajón plástico 60x40x7	60x40x7 plastic drawer	37 €
cajón plástico 60x40x12	60x40x12 plastic drawer	47 €
cerradura puerta inox	SS door lock	31 €
motor lado izquierdo	left side motor	77 €
set 4 ruedas	set 4 wheels	112 €
set 6 ruedas	set 6 wheels	166 €
encimera de granito	granite countertop	consultar
respaldo inox	SS rear side	consultar
230V 60Hz / 115V 60Hz	230V 60Hz / 115V 60Hz	consultar
APPCC	HACCP	incluido

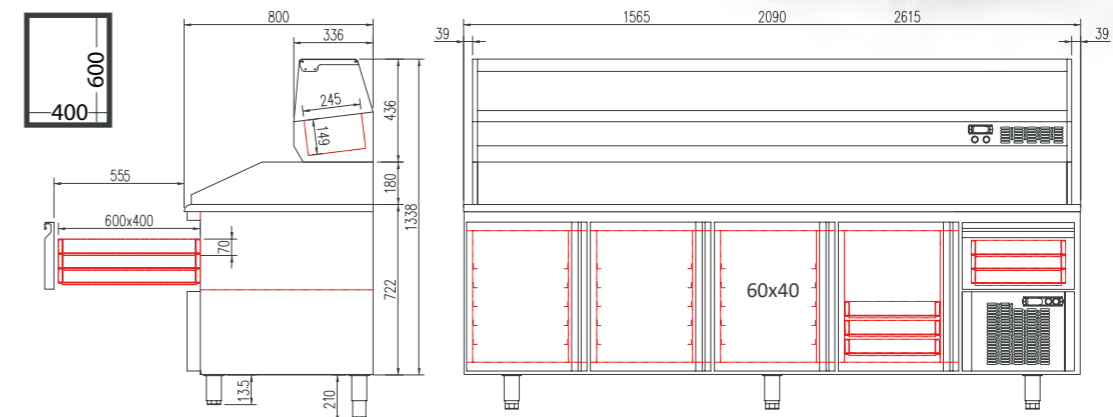



MFP70-180 5.785 € MFP70-225 6.602 € MFP80-200 5.842 € MFP80-250 7.029 €

El precio incluye vitrina de ingredientes - Topping unit included in price



Cubetas GN y perfiles divisorios NO incluidos en el precio, ver página 556
GN containers and dividers NOT included in price, see page 556

mod.	rango range °C	largo length (mm)	alto height (mm)	fondo depth (mm)	estantes shelves	pares guías slides sets	cajas containers 40x60	capacidad GN GN capacity 1/4	volumen capacity (L)	voltaje voltage	refrigerante refrigerant	potencia frig. frig. power W	potencia power W
MFP70-180	0°C +8°C	1795	850	700	2	2	0	8	255	230V-50Hz	R290	502	187
MFP70-225	0°C +8°C	2245	850	700	3	3	0	10	399	230V-50Hz	R290	502	190
MFP80-200	0°C +8°C	2020	850	800	0	10	5	9	362	230V-50Hz	R290	502	187
MFP80-250	0°C +8°C	2545	850	800	0	15	5	12	562	230V-50Hz	R290	502	190

Características técnicas y constructivas sujetas a variación sin previo aviso.

We reserve the right to change specifications without prior notice.

- Exterior en acero inox AISI-304, excepto el respaldo y fondo
- Interior en acero inox AISI-304, con aristas curvas y fondo embutido
- Puertas de apertura reversible, con sistema de cierre automático y burlete magnético (permanece abierta al superar los 90° de apertura)
- Contrapuerta inox embutida
- Encimera de granito, con peto trasero y laterales de 180 mm
- Pies en tubo de acero inox ajustables en altura 135- 210 mm
- Unidad condensadora ventilada y extraíble
- Evaporador sistema tiro forzado, con recubrimiento epoxi anticorrosión
- Evaporación automática del agua de descarche
- Aislamiento de poliuretano inyectado, densidad 40 Kg/m³, cero efectos ODP y GWP
- Control digital de última generación, monitorización en tiempo real, anticipación a incidencias, reducción de averías y simplificación del mantenimiento y uso por APP en smartphone o Tablet
- Expositor de ingredientes independiente, capacidad GN 1/4, incluido
- Temperatura de trabajo 32°C ambiente

- AISI-304 stainless steel exterior, except rear side and base
- AISI-304 stainless steel interior, stamped bottom and rounded corners
- Doors with self closing system, blocked opening, magnetic gasket and possibility of changing the opening sense
- Inner side of doors by stamped steel
- Granite working surface with 180 mm upstands
- AISI -304 adjustable legs, 135 to 210 mm
- Removable and fan assisted condenser unit
- Fan assisted evaporator, with epoxi anticorrosion coating.
- Automatic evaporation of defrost water
- 40 Kg/m³ density polyurethane insulation, zero ODP and GWP
- Next-generation digital control, real-time monitoring, issue anticipation, reduced breakdowns, simplified maintenance, and APP-based operation via smartphone or tablet.
- GN 1/4 topping unit, included
- Operating temperature 32°C ambient

MFP70

- Cuerpo cajonero neutro, 4 cajones sobre guías telescópicas desmontables, contenedores no incluidos
- Estantes interiores GN 1/1 de alambre en acero plastificado, regulables en altura

MFP80

- Interior con guías de acero inox, regulables en altura para parrillas, bandejas o contenedores 60x40
- Cuerpo cajonero neutro, 4 cajones sobre guías telescópicas desmontables, capacidad 60x40, 5 contenedores incluidos

MFP70

- Ambient drawers, 4 removable drawers on telescopic rails, containers not included
- GN 1/1 shelves made of plasticized steel wire, height adjustable

MFP80

- Capacity for 60x40 shelves, containers or trays on stainless steel slides, height adjustable
- Ambient drawers, 4 removable drawers on telescopic rails, capacity 60x40, 5 containers included

Expositor de ingredientes, con luz
Topping unit with light

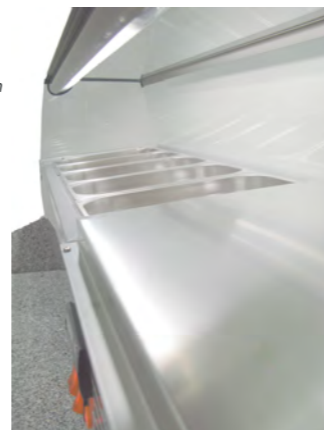

Cuerpo cajonero neutro
Neutral drawers SET

MFP70-225

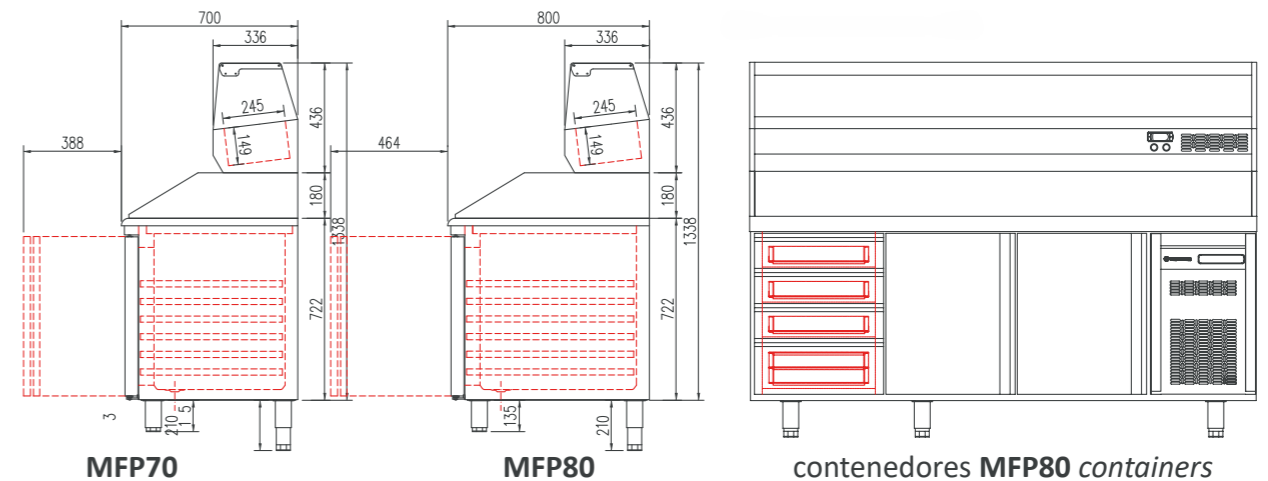

MFP70

MFP80

contenedores MFP80 containers

OPCIONES	OPTIONS	€
set 7 cajones en gama 800	set 7 drawers in range 800	279 €
cerradura puerta inox	SS door lock	31 €
motor lado izquierdo	left side motor	77 €
set 4 ruedas	set 4 wheels	112 €
set 6 ruedas	set 6 wheels	166 €
sin expositor de ingredientes	without ingredient display	consultar
respaldo inox	SS rear side	consultar
230V 60Hz / 115V 60Hz	230V 60Hz / 115V 60Hz	consultar
APPCC	HACCP	incluido

Gama 800 40x60
40x60 range 800



Gama 700 GN 1/1
GN 1/1 range 700



Cajas en Gama 800
Range 800 containers





El precio incluye vitrina de ingredientes - Topping unit included in price



Cubetas GN y perfiles divisorios NO incluidos en el precio, ver página 556
GN containers and dividers NOT included in price, see page 556

mod.	rango range °C	largo length (mm)	alto height (mm)	fondo depth (mm)	estantes shelves	pares guías slides sets	cajas containers 40x60	capacidad GN GN capacity 1/4	volumen capacity (L)	voltaje voltage	refrigerante refrigerant	potencia frig. frig. power W	potencia power W
MR60-150	0°C +8°C	1495	850	600	2	0	0	6	245	230V-50Hz	R290	502	187
MR60-200	0°C +8°C	2020	850	600	3	0	0	9	380	230V-50Hz	R290	502	190
MR60-250	0°C +8°C	2545	850	600	4	0	0	12	516	230V-50Hz	R290	845	305
MR70-135	0°C +8°C	1345	850	700	2	2	0	5	255	230V-50Hz	R290	502	187
MR70-180	0°C +8°C	1795	850	700	3	3	0	8	399	230V-50Hz	R290	502	190
MR70-225	0°C +8°C	2245	850	700	4	4	0	10	543	230V-50Hz	R290	845	305
MR80-150	0°C +8°C	1495	850	800	0	8	3	6	362	230V-50Hz	R290	502	187
MR80-200	0°C +8°C	2020	850	800	0	13	3	9	562	230V-50Hz	R290	502	190
MR80-250	0°C +8°C	2545	850	800	0	18	3	12	761	230V-50Hz	R290	845	305

Características técnicas y constructivas sujetas a variación sin previo aviso.

We reserve the right to change specifications without prior notice.

- **MR60** estantes interiores de alambre en acero plastificado, regulables en altura, sobre apoyos inox
- **MR70** estantes interiores GN 1/1 de alambre en acero plastificado, sobre guías de acero inox regulables en altura
- **MR80** interior con guías de acero inox, regulables en altura para parrillas, bandejas o contenedores 60x40x7 (3 en dotación)
- Exterior en acero inox AISI-304, excepto el respaldo y fondo
- Interior en acero inox AISI-304, con aristas curvas
- Puertas de apertura reversible, con sistema de cierre automático y burlete magnético (permanece abierta al superar los 90° de apertura)
- Contrapuerta inox embutida
- Encimera de granito, con peto trasero y laterales de 180 mm
- Pies en tubo de acero inox ajustables en altura 135- 210 mm
- Unidad condensadora ventilada y extraíble
- Evaporador sistema tiro forzado, con recubrimiento epoxi anticorrosión
- Evaporación automática del agua de descarche
- Aislamiento de poliuretano inyectado, densidad 40 Kg/m³, cero efectos ODP y GWP
- Control digital de última generación, monitorización en tiempo real, anticipación a incidencias, reducción de averías y simplificación del mantenimiento y uso por APP en smartphone o Tablet
- Expositor de ingredientes independiente, capacidad GN 1/4, incluido
- Temperatura de trabajo 32°C ambiente
- **MR60** shelves made of plasticized steel wire, height adjustable
- **MR70** shelves made of plasticized steel wire, height adjustable
- **MR80** capacity for 60x40 shelves, containers or trays on stainless steel slides, height adjustable
- AISI-304 stainless steel exterior, except rear side and base
- AISI-304 stainless steel interior, stamped bottom and rounded corners
- Doors with self closing system, blocked opening, magnetic gasket and possibility of changing the opening sense
- Inner side of doors by stamped steel
- Granite working surface with 180 mm upstands
- AISI -304 adjustable legs, 135 to 210 mm
- Removable and fan assisted condenser unit
- Fan assisted evaporator, with epoxi anticorrosion coating.
- Automatic evaporation of defrost water
- 40 Kg/m³ density polyurethane insulation, zero ODP and GWP
- Next-generation digital control, real-time monitoring, issue anticipation, reduced breakdowns, simplified maintenance, and APP-based operation via smartphone or tablet.
- GN 1/4 topping unit, included
- Operating temperature 32°C ambient

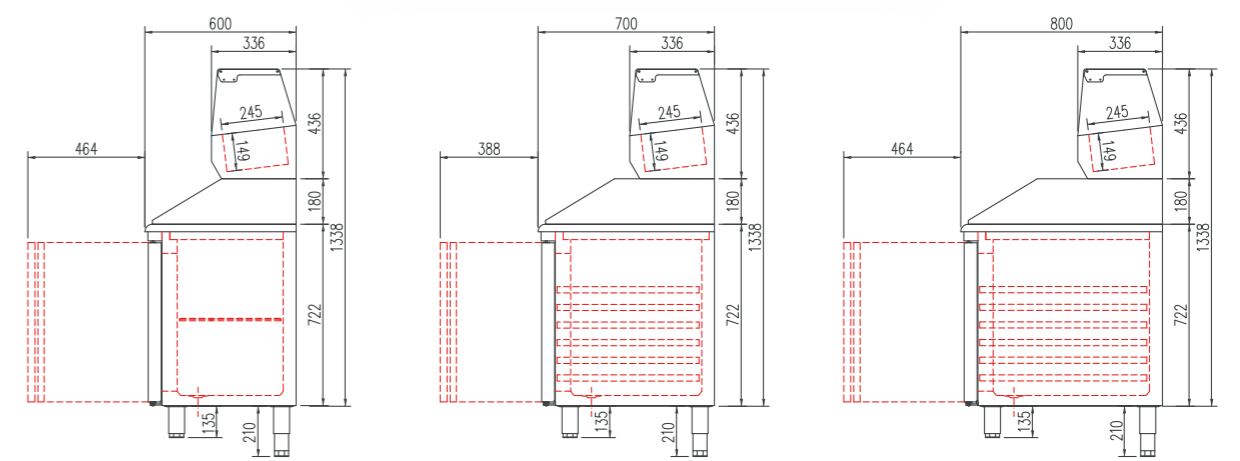

Fondo 600

Fondo 700

Fondo 800

Incremento precio por cambio de puerta a cajonera doble, desmontable sobre guías inox telescópicas, sistema auto-cierre	Increase of price by changing door to double drawers set, detachable telescopic SS runners, soft-closing system	Gama 60	Gama 70
		515 €	648 €

OPCIONES	OPTIONS	€
cerradura puerta inox	SS door lock	31 €
motor lado izquierdo	left side motor	77 €
set 4 ruedas	set 4 wheels	112 €
set 6 ruedas	set 6 wheels	166 €
respaldo inox	SS rear side	consultar
230V 60Hz / 115V 60Hz	230V 60Hz / 115V 60Hz	consultar
sin expositor de ingredientes	without ingredient display	consultar
APPCC	HACCP	incluido





EI-1/4-135	1.576 €
EI-1/4-150	1.600 €
EI-1/4-180	1.712 €
EI-1/4-200	1.775 €
EI-1/4-225	1.861 €
EI-1/4-250	1.985 €

EI-1/3-135	1.634 €
EI-1/3-150	1.664 €
EI-1/3-180	1.775 €
EI-1/3-200	1.839 €
EI-1/3-225	1.890 €
EI-1/3-250	1.973 €

EI-1/4-135-T	1.388 €
EI-1/4-150-T	1.438 €
EI-1/4-180-T	1.564 €
EI-1/4-200-T	1.600 €
EI-1/4-225-T	1.733 €
EI-1/4-250-T	1.825 €

EI-1/3-135-T	1.457 €
EI-1/3-150-T	1.508 €
EI-1/3-180-T	1.634 €
EI-1/3-200-T	1.676 €
EI-1/3-225-T	1.816 €
EI-1/3-250-T	1.903 €



Cubetas GN y perfiles divisorios NO incluidos en el precio, ver página 556
GN containers and dividers NOT included in price, see page 556

mod.	rango range °C	largo length (mm)	fondo depth (mm)	capacidad capacity 1/4	capacidad capacity 1/3	voltaje voltage	refrigerante refrigerant	potencia frig. frig. power W	potencia power W EI-T	potencia power W EI
EI-1/4-135	+2°C +8°C	1345	336	5	0	230V-50Hz	R290	158	131	152
EI-1/4-150	+2°C +8°C	1495	336	6	0	230V-50Hz	R290	170	134	155
EI-1/4-180	+2°C +8°C	1795	336	8	0	230V-50Hz	R290	190	136	162
EI-1/4-200	+2°C +8°C	2020	336	9	0	230V-50Hz	R290	200	138	180
EI-1/4-225	+2°C +8°C	2245	336	10	0	230V-50Hz	R290	502	203	245
EI-1/4-250	+2°C +8°C	2545	336	12	0	230V-50Hz	R290	502	203	245
EI-1/3-135	+2°C +8°C	1345	396	0	5	230V-50Hz	R290	158	131	152
EI-1/3-150	+2°C +8°C	1495	396	0	5	230V-50Hz	R290	170	134	155
EI-1/3-180	+2°C +8°C	1795	396	0	7	230V-50Hz	R290	190	136	162
EI-1/3-200	+2°C +8°C	2020	396	0	8	230V-50Hz	R290	200	138	180
EI-1/3-225	+2°C +8°C	2245	396	0	10	230V-50Hz	R290	502	203	245
EI-1/3-250	+2°C +8°C	2545	396	0	11	230V-50Hz	R290	502	203	245

Características técnicas y constructivas sujetas a variación sin previo aviso.

We reserve the right to change specifications without prior notice.

- EI cúpula de cristal
- EI-T cubierta inox abatible

- EI glass cover options
- EI-T hinged stainless steel cover

- Exterior e interior en acero inox AISI-304
- Capacidad para cubetas GN no incluidas
- Apoyos regulables en altura
- Evaporador por placa fría
- Aislamiento de poliuretano inyectado, densidad 40 Kg/m³, cero efectos ODP y GWP
- Control digital de temperatura, alarma por alta temperatura de condensación. Eficiente gestión del consumo de energía
- Temperatura ambiente de trabajo clase 3 (25°C 60%)

- AISI-304 stainless steel exterior and interior
- GN containers capacity, not included
- Adjustable supports
- Cold plate evaporator
- 40 Kg/m³ density polyurethane insulation, zero ODP and GWP
- Digital temperature control, high-temperature condensation alarm. Efficient management of energy consumption
- Class 3 ambient operating (25°C 60%)

OPCIONES	OPTIONS	€
230V 60Hz / 115V 60Hz	230V 60Hz / 115V 60Hz	consultar
motor lado izquierdo	left side motor	77 €



Luz de serie (EI) Light as standard (EI)

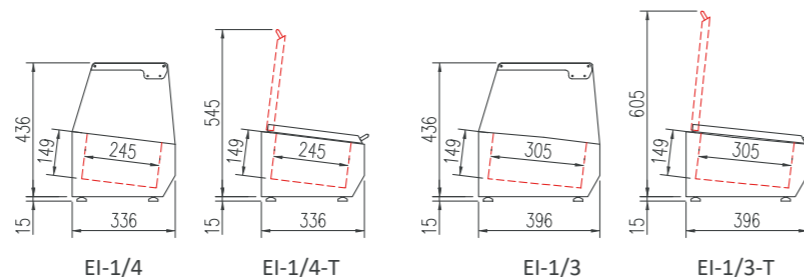

EI-1/4

EI-1/4-T

EI-1/3

EI-1/3-T



EI-1/4-150



GN 1/3-150

EI-1/3-200-T



EI-1/3-225-T

