



**RECINTOS FRIGORÍFICOS MODULARES**  
*MODULAR COLD ROOMS*





RFM-S



CORECO amplia la gama de recintos frigoríficos, presentando el sistema de unión de paneles sin columnas, como alternativa a nuestro tradicional concepto de montaje con columnas

Esta nueva solución estructural, pone en el mercado una alternativa tan eficiente como la tradicional, mantiene la modularidad que permite cubrir las necesidades de espacio que cada instalación requiere

*CORECO expanded the range of products, providing an alternative to our traditional system for mounting panels with columns.*

*This new structural conception, puts on the market an alternative as efficient as the traditional one, keeping the modularity that let you find the proper solution to your needs*

CORECO Configurador de Recintos Frigoríficos



Esta aplicación web le permitirá configurar una cámara frigorífica en muy poco tiempo siguiendo unos sencillos pasos. Una vez finalizado el proceso, deberá rellenar un formulario indicando algunos datos básicos de contacto con el fin de que podamos proporcionarle un presupuesto acorde a sus necesidades.

CONFIGURAR

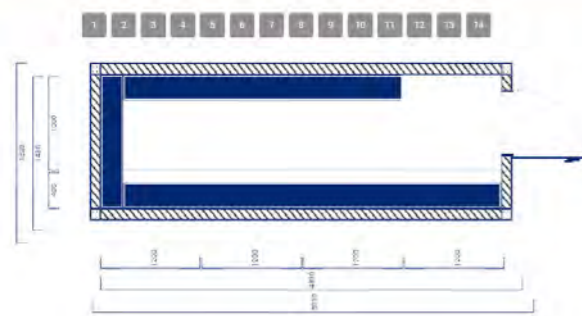

Seguimos evolucionando la herramienta de configuración que, desde PC o dispositivo móvil, le permite componer su cámara y recibir por correo electrónico un completo informe con la información más relevante:

- Dimensiones y volumen
- Tipo y acabados del suelo
- Composición de paneles
- Posición y apertura de la puerta
- Configuración de estanterías
- Equipo frigorífico recomendado

**Configurador WEB**  
WEB configurator



*We continue updating the configuration tool that, from PC or mobile device, allows you to compose your camera and receive by email a complete report with the most relevant information:*

- Dimensions and volume
- Type and floor finishes
- Composition of panels
- Position and opening of the door
- Shelving configuration
- Recommended refrigeration equipment

11a

**RECINTOS MODULARES SERIE RFM**  
RFM MODULAR COLDROOMS  
pag. 422 - 449



11b

**ARMARIOS DESMONTABLES SERIE AFD**  
AFD MODULAR REACH-IN  
pag. 454 - 461



11c

**RECINTOS MODULARES SERIE RFM-S**  
RFM-S MODULAR COLDROOMS  
pag. 466 - 493



11d

**RECINTOS ESPECIALES SERIE RFM**  
RFM MODULAR SPECIAL COLDROOMS  
pag. 494 - 505



11e

**CORTINAS DE LAMAS**  
PVC CURTAINS  
pag. 508 - 509



11f

**EQUIPOS FRIGORÍFICOS**  
COOLING UNITS  
pag. 520 - 555



**RECINTOS RFM CON PUERTAS DE CRISTAL**  
RFM COLD-ROOMS WITH GLASS DOOR  
pag. 450 - 453



**ARMARIOS AFD CON PUERTAS DE CRISTAL**  
AFD REACH-IN WITH GLASS DOOR  
pag. 462 - 465



S-line

**ESTANTERIAS**  
SHELVING  
pag. 510 - 519



## VERSATILIDAD - VERSATILITY

La versatilidad, siempre ha sido un valor añadido a la marca CORECO.

Aplicamos este valor a todos nuestros productos, y los recintos frigoríficos no son una excepción.

Cuando los modelos estándar no llegan a cubrir la necesidad de la instalación, aplicamos nuestra experiencia para dar respuesta a la exigencia que el proyecto pueda plantearnos, siempre dentro de los estándares de calidad que empleamos en la producción de paneles.

*Versatility has always been an added value to the CORECO brand.*

*We apply this value to all our products, and cold rooms are no exception.*

*When the standard models do not cover the installation needs, we apply our experience to respond to the requirements that the project may pose, always within the quality standards that we use in the production of panels.*

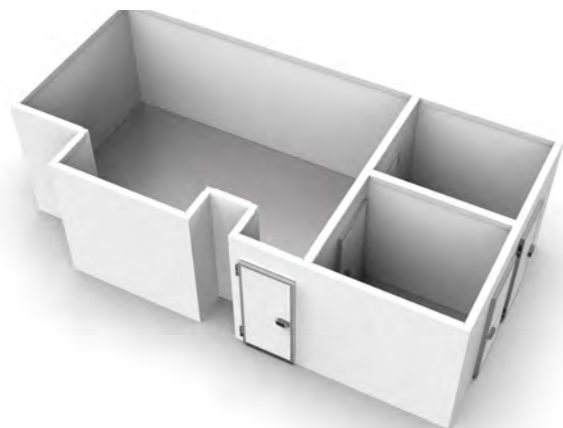

## VERSATILIDAD - VERSATILITY

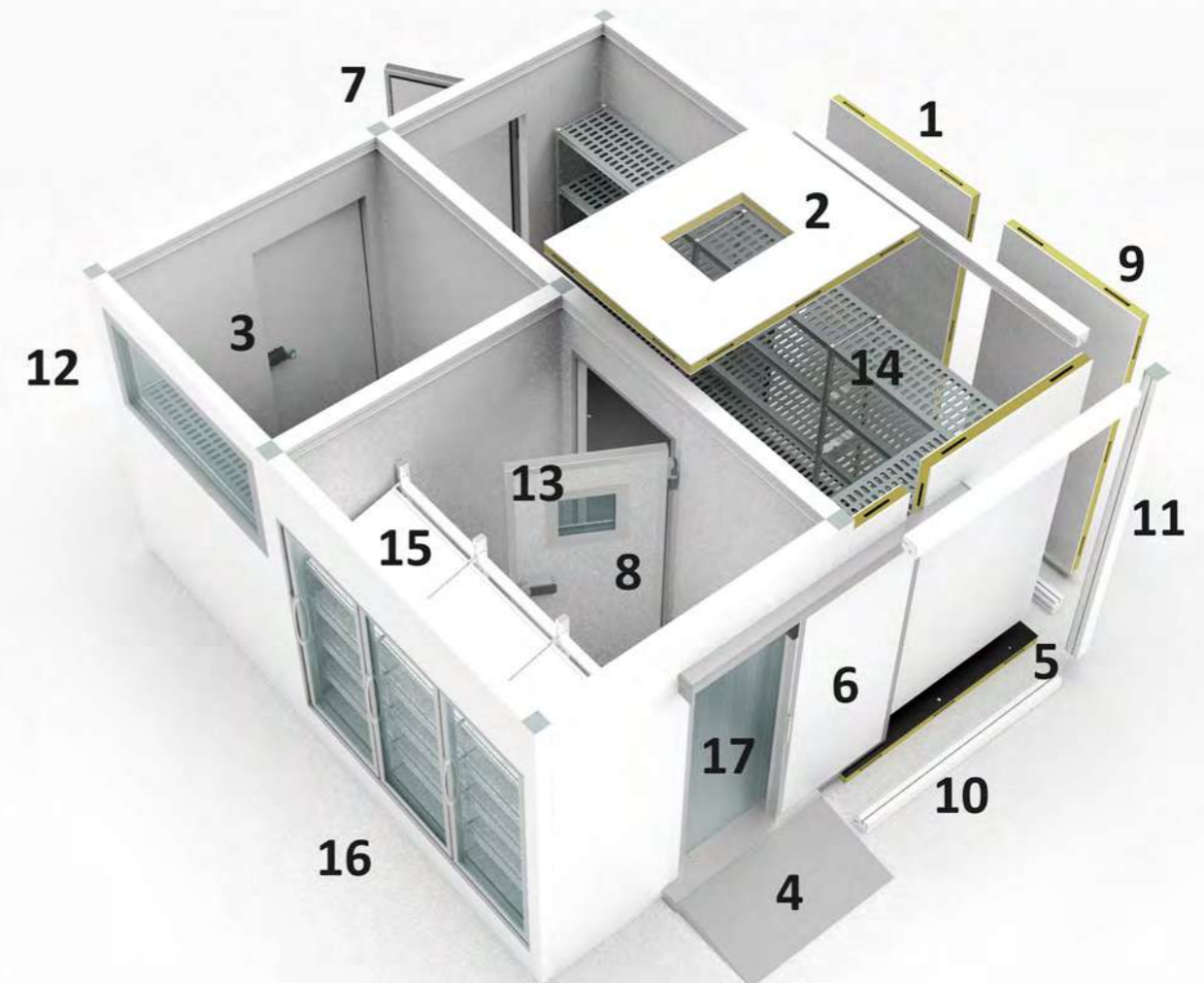

- 1- aislamiento densidad 45 Kg/m<sup>3</sup>
- 2- equipo frigorífico en pared o techo
- 3- paredes interiores
- 4- rampas de acceso
- 5- tres acabados en suelo
- 6- puertas correderas
- 7- puertas con bisagras
- 8- puertas interiores
- 9- sistema unión excéntrico
- 10- perfil sanitario integrado
- 11- columnas perimetrales
- 12 - ventanas
- 13- puertas con ventanuco
- 14- estanterías
- 15- estanterías auto-servicio
- 16 - puertas auto-servicio
- 17- cortinas de lamas

- 1- 45Kg/m<sup>3</sup> insulation
- 2- cooling units on top or sides
- 3- internal walls
- 4- access ramps
- 5- three floor finishing
- 6- sliding doors
- 7- hinged doors
- 8- internal doors
- 9- eccentric hokk system
- 10- integrated sanitary profile
- 11- perimetral columns
- 12 - windows
- 13- display doors
- 14- shelving
- 15- self-service shelving
- 16 - self-service glazed doors
- 17- PVC curtains

**RECINTOS FRIGORÍFICOS MODULARES**  
*MODULAR COLD ROOMS*

**MODULOS RFM CON PUERTAS DE CRISTAL**  
*RFM MODULES WITH GLASS DOORS*





CORECO le presenta la gama de Recintos Frigoríficos Modulares, RFM

En nuestras instalaciones CORECO Centro 2, hemos desarrollado recintos frigoríficos modulares desde la concepción del producto, pasando por el diseño, fabricación, embalaje y comercialización... hemos dedicado la máxima atención y esfuerzo, sobre todo a los pequeños detalles.

En nuestra fabricación empleamos maquinaria sofisticada controlada por computadora y personal bien cualificado. El resultado es un recinto frigorífico con personalidad propia y adaptado al mercado actual.

CORECO presents the Modular Cold Rooms range RFM  
We have developed modular cold rooms in our CORECO Centro 2 facilities, from product conception, through design, manufacturing, packaging and marketing ... we have devoted the utmost attention and effort, especially to small details.

We employ sophisticated computer controlled machinery and well-trained personnel in our manufacturing. The result is a cold room with own personality, adapted and ready to be competitive in the current market.



Mecanismo de ganchos excéntricos de doble efecto (gira y recoge)

Double effect eccentric hooks mechanism (turns and locks)

## SECCIÓN Y ALTURAS / HEIGHTS AND SECTIONS

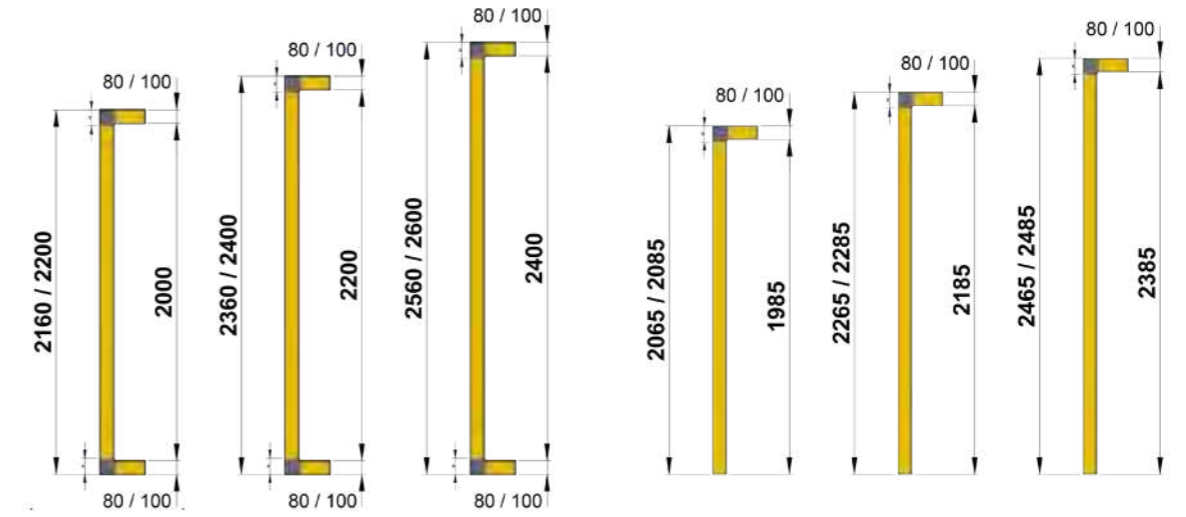

CON suelo panel  
WITH floor panel

SIN suelo panel  
WITHOUT floor panel

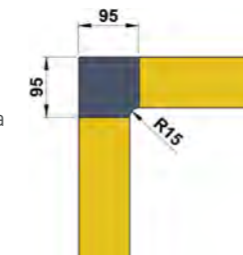

Dimensiones de la columna para espesor 80 mm.  
Column size for 80mm thickness.

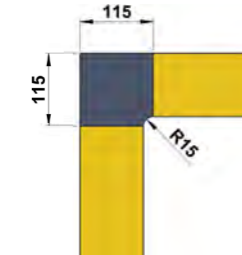

Dimensiones de la columna para espesor 100 mm.  
Column size for 100mm thickness.

## ESPACIOS NECESARIOS PARA UNA CORRECTA INSTALACIÓN

Recomendamos una adecuada nivelación del suelo donde vaya a ser instalado el recinto frigorífico. Prever que el lugar de ubicación permite el acceso del panel de mayor dimensión.

## SPACE NEEDED FOR CORRECT INSTALLATION

We recommend an adequate leveling of the floor where the cold room will be installed. Ensure that the location allows access with the largest panel.

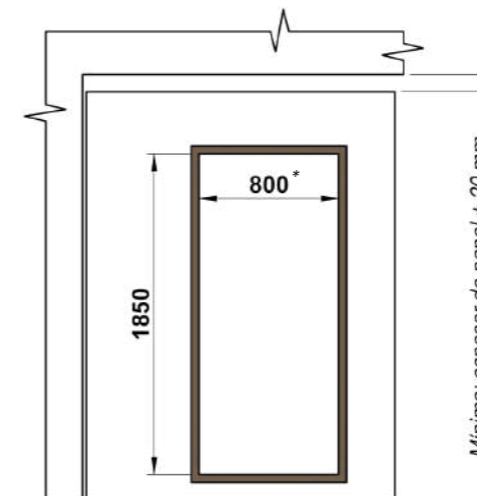

\*Bajo pedido, 600, 700, 900 y 1000  
\*On demand 600, 700, 900 and 1000

Para poder realizar un montaje correcto es necesario dejar entre el techo del local y el techo del recinto al menos el espesor del panel + 20 mm.

For correct assembly, leave at least the thickness of a panel + 20mm between the roof of the premises and the roof of the room.

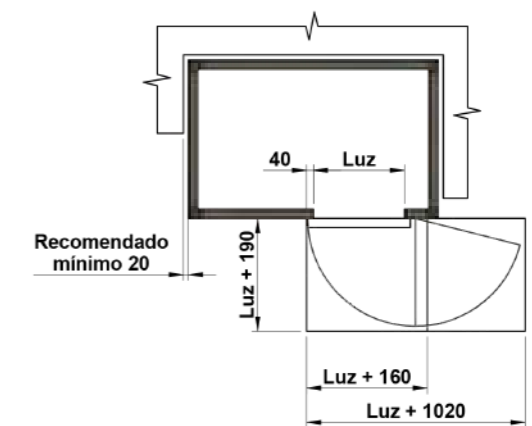

Dimensiones necesarias para una apertura de la puerta a 90° y 180°

Measurements needed to open the door at 90° and 180°

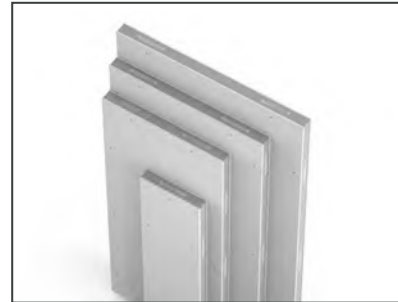

**Paneles:**

- Espesor de 80 y 100 mm.
- Modularidad 400, 800, 1000 y 1200 mm facilita la adaptabilidad a las dimensiones de su recinto.
- Longitud máxima del panel 3000 mm.

**Panels:**

- 80 and 100mm thickness.
- 400, 800, 1000 and 1200mm modules to suit the size of your room.
- Maximum panel length 3000mm.

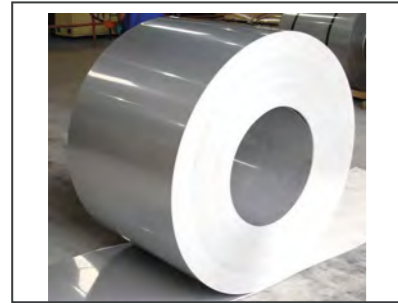

**Revestimiento:**

- Revestimiento estándar en acero galvanizado prelacado poliéster, con film de protección.
- Color blanco pirineo.
- Calidad alimentaria.

**Cladding:**

- Galvanized steel cladding pre-lacquered with polyester, with a protective film, as standard.
- Colour white, "blanco pirineo".
- Food grade.



**Aislamiento:**

- Espuma rígida de poliuretano, libre de CFC e inyectado a alta presión
- Densidad 45 Kg. / m<sup>2</sup>
- Coeficiente de conductividad térmica 0.022W/mK a 10°C. (Sin envejecimiento)

**Insulation:**

- Rigid polyurethane foam, CFC-free, injected at high pressure.
- Density 45kg/m<sup>2</sup>.
- Thermal conductivity coefficient 0.022W/mK at 10°C. (Without ageing).



**Terminación del Panel de Suelo:**

- Suelo reforzado: Idóneo para el tránsito de personas y carretillas manuales. Acabado interior de contrachapado de abedul y resina fenólica antideslizante.
- Suelo de acero inoxidable antideslizante aisi 304 18/8.
- Suelo de chapa lacada blanca igual que el resto de paneles.

**Floor Panel Finish:**

- Reinforced flooring: Ideal for the transit of people and manual trucks. Birch plywood interior finish with non-slip phenolic resin.
- Non-slip stainless steel flooring AISI 304 18/8.
- Metal flooring lacquered white the same as the rest of the panels.



**Columnas verticales y horizontales:**

- Columnas perimetrales con innovador perfil sanitario de labio flexible
- Unión perfecta de gran calidad.
- Revestimiento exterior en el mismo material usado en los paneles
- Línea estética regular en toda la cámara.
- Conjunto inyectado con poliuretano

**Vertical and horizontal columns:**

- Perimeter columns with innovative sanitary flexible lip seal.
- High quality perfect joints.
- Exterior cladding in the same material as the panels.
- Regular aesthetic line throughout the room.
- Everything is injected with polyurethane.



**Sistema de Unión:**

- Mecanismo de ganchos excéntricos de alta resistencia y doble efecto (gira y recoge), colocados en carcasas de ABS. El conjunto está pensado para trabajar de dos maneras: engancha y puede ser enganchado.

**Connecting System:**

- High resistance and double effect eccentric hooks mechanism (turns and locks), installed in ABS housings. The combination is designed to work in two ways: it engages and can be hooked.

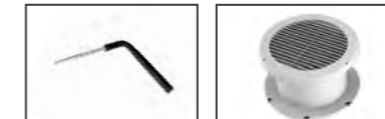
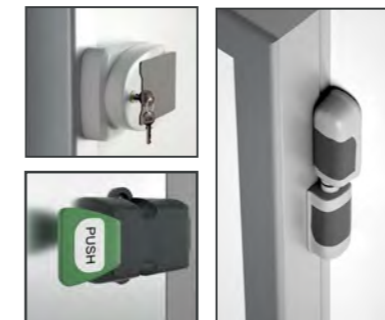
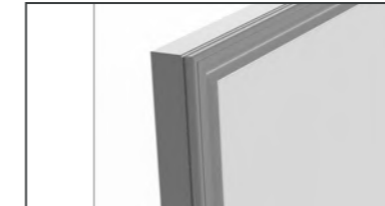
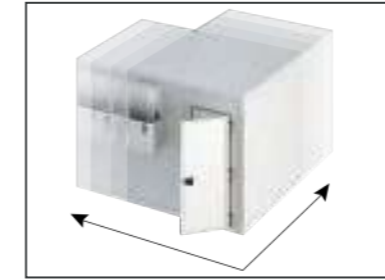

**Modularidad:**

- Dos espesores: 80 y 100 mm.
- Modularidad 200 mm.
- Tres alturas exteriores diferentes

**Modularity:**

- Two thicknesses: 80 and 100mm.
- Modulation 200mm.
- Three different external heights.

**Puerta:**

- Espesor 80 mm
- Marco perimetral exterior de aluminio anodizado anticorrosión.
- Burlete de estanqueidad.
- Hueco de luz 1850 x 800 mm.
- Sólo en panel 100 mm: resistencia eléctrica antiescarcha colocada en el marco del panel de puerta.
- Tanto el panel puerta como la puerta están inyectados en su interior con el mismo aislamiento del resto de paneles.
- Bisagras con regulación y pasador inoxidable.
- Cierre con llave y con un punto de presión.

**Door:**

- 80 mm thickness
- Exterior perimeter frame made of anodized anti-corrosion aluminium.
- Sealing gasket.
- A light shaft of 1850mm and 800mm.
- Only for 100 mm panel: frost prevention electric resistance placed on door panel frame.
- Both the door panel and the door are injected with the same insulation as the rest of the panels.
- Adjustable hinges with stainless steel pin.
- Locks with key and pressure point.

**Accesorios incluidos:**

- Válvula compensadora de presiones para todas las cámaras de espesor 100
- Caja de conexiones y resistencia marco sólo en puerta para panel 100
- Perfil sanitario con labio flexible, incorporado en todos los perfiles COLUMNA
- Perfil "U" de montaje para cámaras sin panel de suelo
- Luz interior
- Llave hexagonal con mango para montaje de las fijaciones de paneles

**Parts included:**

- Pressure compensation valve for all chambers of thickness 100
- Junction box and resistance frame only in door for panel 100
- Incorporated sanitary profile with flexible lip, in all COLUMNS
- Mounting "U" profile for cameras without floor panel
- Interior light
- Hexagonal wrench with handle for mounting panel fixings

**OPCIONES bajo pedido**

- Otras calidades y colores para el revestimiento del panel tanto para el exterior como en el interior
- Suelo con acabado interior en acero inoxidable antideslizante
- Suelo con acabado blanco pirineo, igual al resto de paneles
- Equipo frigorífico
- Estanterías de aluminio y polietileno de fabricación propia.
- Resistencia eléctrica en cámaras de espesor 80 mm.
- Puerta apertura a mano izquierda (estándar abre a mano derecha)
- Puerta corredera 1850 x 800 mm
- Huecos de puerta, abatible o corredera, con anchos especiales: 600, 700, 900 y 1000 mm
- Hacha de bombero
- Soporte hacha
- Alarma hombre atrapado
- Rampa para puerta abatible o corredera
- Rastreles para separación entre el panel inferior y el suelo

**OPTIONS on request**

- Other qualities and colors for the panel covering both for the exterior and interior
- Floor with non-slip stainless steel interior finish
- Floor with a white pyrenean finish, the same as the other panels
- Refrigeration equipment
- Self-made aluminum and polyethylene shelves.
- Electrical resistance in chambers of thickness 80 mm.
- Door open on the left (standard opens on the right)
- Sliding door 1850 x 800 mm
- Door openings, pivoting or sliding, with special widths: 600, 700, 900 and 1000 mm
- Fire ax
- Ax support
- Trapped man alarm
- Ramp for swing or sliding door
- Tracks for separation between bottom panel and base floor





En las tablas de la siguiente página, se identifica el modelo del recinto correspondiente con el espesor de aislamiento (80 / 100 mm) y las medias en planta (largo y fondo).

Este código le dirigirá a la página correspondiente, donde en base a la altura y tipo de suelo, podrá determinar código y precio del recinto.

También se identifica en la tabla particular para cada configuración, el volumen interior de la cámara, lo cual le ayudará a seleccionar el equipo frigorífico apropiado.

The tables on the following page show the corresponding room model with an insulation thickness of 80/100mm and its floor measurements (length and width).

Use the code to locate the corresponding page, where based on the height and type of floor, you can determine the code and price of the room.

For each room layout the table also gives its interior volume, to help you to select the appropriate refrigerator equipment.

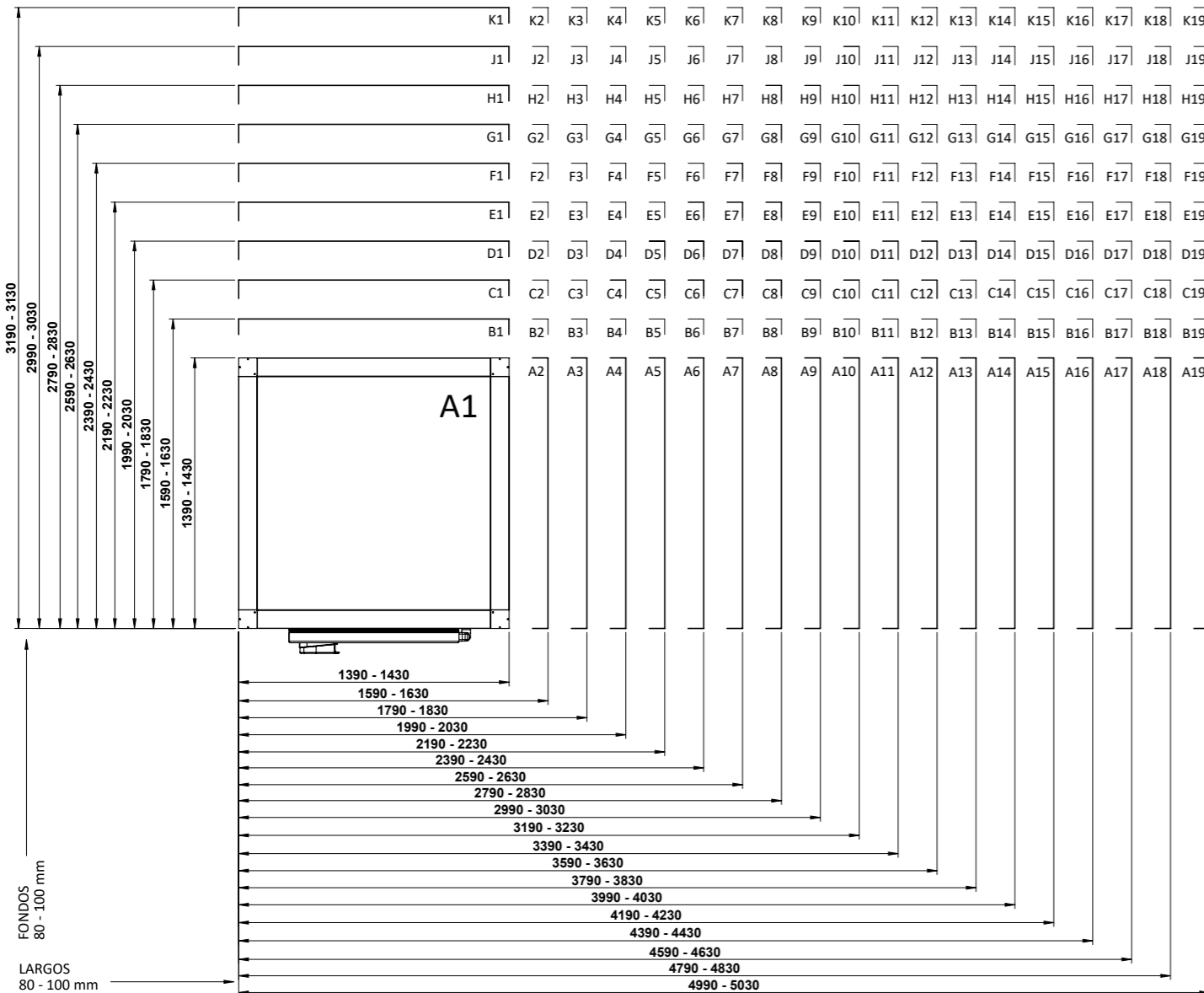

\*Ejemplo de elección  
D4, 80 mm.: Fondo 1990 mm. Largo 1990 mm.

\*Example choices  
D4, 80mm.: Depth 1990mm. Length 1990mm.

80		Largo - Length (L) mm																			PAG
		1390	1590	1790	1990	2190	2390	2590	2790	2990	3190	3390	3590	3790	3990	4190	4390	4590	4790	4990	
Fondo - Depth mm	1390	A1	A2	A3	A4	A5	A6	A7	A8	A9	A10	A11	A12	A13	A14	A15	A16	A17	A18	A19	18
	1590	B1	B2	B3	B4	B5	B6	B7	B8	B9	B10	B11	B12	B13	B14	B15	B16	B17	B18	B19	20
	1790	C1	C2	C3	C4	C5	C6	C7	C8	C9	C10	C11	C12	C13	C14	C15	C16	C17	C18	C19	22
	1990	D1	D2	D3	D4	D5	D6	D7	D8	D9	D10	D11	D12	D13	D14	D15	D16	D17	D18	D19	24
	2190	E1	E2	E3	E4	E5	E6	E7	E8	E9	E10	E11	E12	E13	E14	E15	E16	E17	E18	E19	26
	2390	F1	F2	F3	F4	F5	F6	F7	F8	F9	F10	F11	F12	F13	F14	F15	F16	F17	F18	F19	28
	2590	G1	G2	G3	G4	G5	G6	G7	G8	G9	G10	G11	G12	G13	G14	G15	G16	G17	G18	G19	30
	2790	H1	H2	H3	H4	H5	H6	H7	H8	H9	H10	H11	H12	H13	H14	H15	H16	H17	H18	H19	32
	2990	J1	J2	J3	J4	J5	J6	J7	J8	J9	J10	J11	J12	J13	J14	J15	J16	J17	J18	J19	34
	3190	K1	K2	K3	K4	K5	K6	K7	K8	K9	K10	K11	K12	K13	K14	K15	K16	K17	K18	K19	36

100		Largo - Length (L) mm																			PAG
		1430	1630	1830	2030	2230	2430	2630	2830	3030	3230	3430	3630	3830	4030	4230	4430	4630	4830	5030	
Fondo - Depth mm	1430	A1	A2	A3	A4	A5	A6	A7	A8	A9	A10	A11	A12	A13	A14	A15	A16	A17	A18	A19	19
	1630	B1	B2	B3	B4	B5	B6	B7	B8	B9	B10	B11	B12	B13	B14	B15	B16	B17	B18	B19	21
	1830	C1	C2	C3	C4	C5	C6	C7	C8	C9	C10	C11	C12	C13	C14	C15	C16	C17	C18	C19	23
	2030	D1	D2	D3	D4	D5	D6	D7	D8	D9	D10	D11	D12	D13	D14	D15	D16	D17	D18	D19	25
	2230	E1	E2	E3	E4	E5	E6	E7	E8	E9	E10	E11	E12	E13	E14	E15	E16	E17	E18	E19	27
	2430	F1	F2	F3	F4	F5	F6	F7	F8	F9	F10	F11	F12	F13	F14	F15	F16	F17	F18	F19	29
	2630	G1	G2	G3	G4	G5	G6	G7	G8	G9	G10	G11	G12	G13	G14	G15	G16	G17	G18	G19	31
	2830	H1	H2	H3	H4	H5	H6	H7	H8	H9	H10	H11	H12	H13	H14	H15	H16	H17	H18	H19	33
	3030	J1	J2	J3	J4	J5	J6	J7	J8	J9	J10	J11	J12	J13	J14	J15	J16	J17	J18	J19	35
	3230	K1	K2	K3	K4	K5	K6	K7	K8	K9	K10	K11	K12	K13	K14	K15	K16	K17	K18	K19	37

A la hora de elegir su cámara, tenga en cuenta que la ubicación de la puerta estará siempre colocada en el largo.  
At time of choosing your Cold Room, keep in mind that the location of the door will always be placed on the length part of the Cold Room.

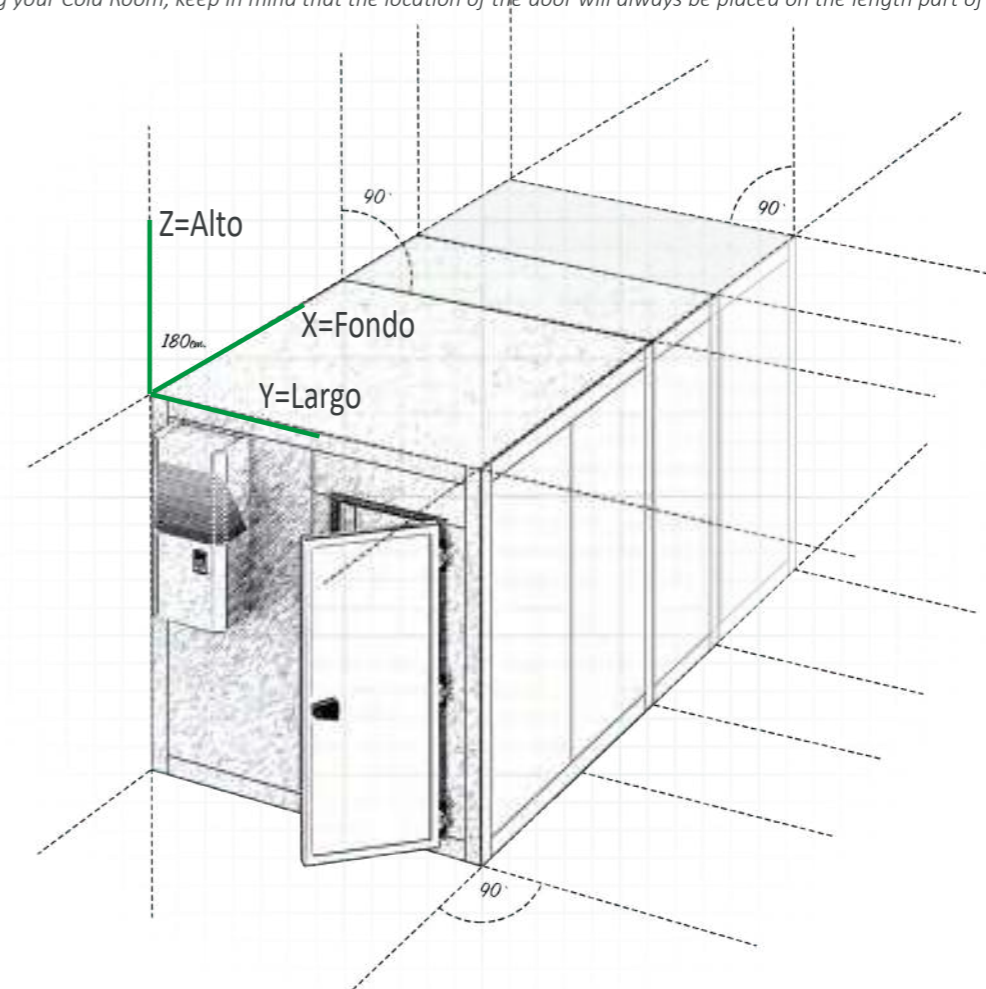



<b>80</b>	Largo - Length (L)																		
	1390	1590	1790	1990	2190	2390	2590	2790	2990	3190	3390	3590	3790	3990	4190	4390	4590	4790	4990
Fondo - Depth mm 1390	A1	A2	A3	A4	A5	A6	A7	A8	A9	A10	A11	A12	A13	A14	A15	A16	A17	A18	A19

<b>80</b>	CON suelo - WITH floor panel					SIN suelo - WITHOUT floor panel				
	COD	m²	L	H	€	COD	m²	L	H	€
<b>A1</b>	A1R-139139AC	3.03	1390	2160	<b>3.058 €</b>	A1R-139139AS	3	1390	2065	<b>2.719 €</b>
	A1R-139139BC	3.33	1390	2360	<b>3.214 €</b>	A1R-139139BS	3.31	1390	2265	<b>2.870 €</b>
	A1R-139139CC	3.63	1390	2560	<b>3.364 €</b>	A1R-139139CS	3.61	1390	2465	<b>3.021 €</b>
<b>A2</b>	A2R-139159AC	3.52	1590	2160	<b>3.267 €</b>	A2R-139159AS	3.49	1590	2065	<b>2.872 €</b>
	A2R-139159BC	3.87	1590	2360	<b>3.428 €</b>	A2R-139159BS	3.84	1590	2265	<b>3.034 €</b>
	A2R-139159CC	4.22	1590	2560	<b>3.591 €</b>	A2R-139159CS	4.19	1590	2465	<b>3.193 €</b>
<b>A3</b>	A3R-139179AC	4.01	1790	2160	<b>3.472 €</b>	A3R-139179AS	3.98	1790	2065	<b>3.025 €</b>
	A3R-139179BC	4.41	1790	2360	<b>3.646 €</b>	A3R-139179BS	4.38	1790	2265	<b>3.197 €</b>
	A3R-139179CC	4.81	1790	2560	<b>3.822 €</b>	A3R-139179CS	4.78	1790	2465	<b>3.370 €</b>
<b>A4</b>	A4R-139199AC	4.5	1990	2160	<b>3.682 €</b>	A4R-139199AS	4.47	1990	2065	<b>3.176 €</b>
	A4R-139199BC	4.95	1990	2360	<b>3.865 €</b>	A4R-139199BS	4.92	1990	2265	<b>3.362 €</b>
	A4R-139199CC	5.4	1990	2560	<b>4.050 €</b>	A4R-139199CS	5.37	1990	2465	<b>3.544 €</b>
<b>A5</b>	A5R-139219AC	4.99	2190	2160	<b>3.887 €</b>	A5R-139219AS	4.96	2190	2065	<b>3.328 €</b>
	A5R-139219BC	5.49	2190	2360	<b>4.080 €</b>	A5R-139219BS	5.46	2190	2265	<b>3.526 €</b>
	A5R-139219CC	5.99	2190	2560	<b>4.274 €</b>	A5R-139219CS	5.96	2190	2465	<b>3.717 €</b>
<b>A6</b>	A6R-139239AC	5.49	2390	2160	<b>4.097 €</b>	A6R-139239AS	5.44	2390	2065	<b>3.487 €</b>
	A6R-139239BC	6.03	2390	2360	<b>4.305 €</b>	A6R-139239BS	5.99	2390	2265	<b>3.688 €</b>
	A6R-139239CC	6.58	2390	2560	<b>4.508 €</b>	A6R-139239CS	6.54	2390	2465	<b>3.892 €</b>
<b>A7</b>	A7R-139259AC	5.98	2590	2160	<b>4.308 €</b>	A7R-139259AS	5.93	2590	2065	<b>3.637 €</b>
	A7R-139259BC	6.58	2590	2360	<b>4.519 €</b>	A7R-139259BS	6.53	2590	2265	<b>3.853 €</b>
	A7R-139259CC	7.17	2590	2560	<b>4.731 €</b>	A7R-139259CS	7.13	2590	2465	<b>4.067 €</b>
<b>A8</b>	A8R-139279AC	6.47	2790	2160	<b>4.515 €</b>	A8R-139279AS	6.42	2790	2065	<b>3.790 €</b>
	A8R-139279BC	7.12	2790	2360	<b>4.732 €</b>	A8R-139279BS	7.07	2790	2265	<b>4.012 €</b>
	A8R-139279CC	7.76	2790	2560	<b>4.963 €</b>	A8R-139279CS	7.72	2790	2465	<b>4.243 €</b>
<b>A9</b>	A9R-139299AC	6.96	2990	2160	<b>4.720 €</b>	A9R-139299AS	6.91	2990	2065	<b>3.946 €</b>
	A9R-139299BC	7.66	2990	2360	<b>4.959 €</b>	A9R-139299BS	7.61	2990	2265	<b>4.181 €</b>
	A9R-139299CC	8.35	2990	2560	<b>5.190 €</b>	A9R-139299CS	8.3	2990	2465	<b>4.413 €</b>
<b>A10</b>	A10R-139319AC	7.45	3190	2160	<b>4.931 €</b>	A10R-139319AS	7.4	3190	2065	<b>4.097 €</b>
	A10R-139319BC	8.2	3190	2360	<b>5.176 €</b>	A10R-139319BS	8.14	3190	2265	<b>4.344 €</b>
	A10R-139319CC	8.94	3190	2560	<b>5.412 €</b>	A10R-139319CS	8.89	3190	2465	<b>4.587 €</b>
<b>A11</b>	A11R-139339AC	7.95	3390	2160	<b>5.278 €</b>	A11R-139339AS	7.89	3390	2065	<b>4.277 €</b>
	A11R-139339BC	8.74	3390	2360	<b>5.530 €</b>	A11R-139339BS	8.68	3390	2265	<b>4.528 €</b>
	A11R-139339CC	9.53	3390	2560	<b>5.782 €</b>	A11R-139339CS	9.48	3390	2465	<b>4.776 €</b>
<b>A12</b>	A12R-139359AC	8.44	3590	2160	<b>5.492 €</b>	A12R-139359AS	8.37	3590	2065	<b>4.429 €</b>
	A12R-139359BC	9.28	3590	2360	<b>5.757 €</b>	A12R-139359BS	9.22	3590	2265	<b>4.694 €</b>
	A12R-139359CC	10.13	3590	2560	<b>6.023 €</b>	A12R-139359CS	10.06	3590	2465	<b>4.944 €</b>
<b>A13</b>	A13R-139379AC	8.93	3790	2160	<b>5.706 €</b>	A13R-139379AS	8.86	3790	2065	<b>4.580 €</b>
	A13R-139379BC	9.82	3790	2360	<b>5.985 €</b>	A13R-139379BS	9.76	3790	2265	<b>4.856 €</b>
	A13R-139379CC	10.72	3790	2560	<b>6.263 €</b>	A13R-139379CS	10.65	3790	2465	<b>5.113 €</b>
<b>A14</b>	A14R-139399AC	9.42	3990	2160	<b>5.920 €</b>	A14R-139399AS	9.35	3990	2065	<b>4.731 €</b>
	A14R-139399BC	10.36	3990	2360	<b>6.210 €</b>	A14R-139399BS	10.29	3990	2265	<b>5.021 €</b>
	A14R-139399CC	11.31	3990	2560	<b>6.499 €</b>	A14R-139399CS	11.24	3990	2465	<b>5.284 €</b>
<b>A15</b>	A15R-139419AC	9.91	4190	2160	<b>6.136 €</b>	A15R-139419AS	9.84	4190	2065	<b>4.882 €</b>
	A15R-139419BC	10.91	4190	2360	<b>6.438 €</b>	A15R-139419BS	10.83	4190	2265	<b>5.184 €</b>
	A15R-139419CC	11.9	4190	2560	<b>6.740 €</b>	A15R-139419CS	11.82	4190	2465	<b>5.454 €</b>
<b>A16</b>	A16R-139439AC	10.41	4390	2160	<b>6.350 €</b>	A16R-139439AS	10.33	4390	2065	<b>5.031 €</b>
	A16R-139439BC	11.45	4390	2360	<b>6.664 €</b>	A16R-139439BS	11.37	4390	2265	<b>5.348 €</b>
	A16R-139439CC	12.49	4390	2560	<b>6.980 €</b>	A16R-139439CS	12.41	4390	2465	<b>5.624 €</b>
<b>A17</b>	A17R-139459AC	10.9	4590	2160	<b>6.564 €</b>	A17R-139459AS	10.82	4590	2065	<b>5.184 €</b>
	A17R-139459BC	11.99	4590	2360	<b>6.892 €</b>	A17R-139459BS	11.91	4590	2265	<b>5.512 €</b>
	A17R-139459CC	13.08	4590	2560	<b>7.219 €</b>	A17R-139459CS	13	4590	2465	<b>5.794 €</b>
<b>A18</b>	A18R-139479AC	11.39	4790	2160	<b>6.779 €</b>	A18R-139479AS	11.3	4790	2065	<b>5.335 €</b>
	A18R-139479BC	12.53	4790	2360	<b>7.119 €</b>	A18R-139479BS	12.44	4790	2265	<b>5.676 €</b>
	A18R-139479CC	13.67	4790	2560	<b>7.457 €</b>	A18R-139479CS	13.58	4790	2465	<b>5.967 €</b>
<b>A19</b>	A19R-139499AC	11.88	4990	2160	<b>6.992 €</b>	A19R-139499AS	11.79	4990	2065	<b>5.486 €</b>
	A19R-139499BC	13.07	4990	2360	<b>7.343 €</b>	A19R-139499BS	12.98	4990	2265	<b>5.839 €</b>
	A19R-139499CC	14.26	4990	2560	<b>7.698 €</b>	A19R-139499CS	14.17	4990	2465	<b>6.136 €</b>

<b>100</b>	Largo - Length (L)																			
	1430	1630	1830	2030	2230	2430	2630	2830	3030	3230	3430	3630	3830	4030	4230	4430	4630	4830	5030	
Fondo - Depth mm 1430	A1	A2	A3	A4	A5	A6	A7	A8	A9	A10	A11	A12	A13	A14	A15	A16	A17	A18	A19	

<b>100</b>	CON suelo - WITH floor panel					SIN suelo - WITHOUT floor panel				
	COD	m²	L	H	€	COD	m²	L	H	€
<b>A1</b>	A1C-143143AC	3.03	1430	2200	<b>3.347 €</b>	A1C-143143AS	3	1430	2085	<b>3.000 €</b>
	A1C-143143BC	3.33	1430	2400	<b>3.515 €</b>	A1C-143143BS	3.31	1430	2285	<b>3.161 €</b>
	A1C-143143CC	3.63	1430	2600	<b>3.680 €</b>	A1C-143143CS	3.61	1430	2485	<b>3.332 €</b>
<b>A2</b>	A2C-143163AC	3.52	1630	2200	<b>3.569 €</b>	A2C-143163AS	3.49	1630	2085	<b>3.164 €</b>
	A2C-143163BC	3.87	1630	2400	<b>3.745 €</b>	A2C-143163BS	3.84	1630	2285	<b>3.338 €</b>
	A2C-143163CC	4.22	1630	2600	<b>3.919 €</b>	A2C-143163CS	4.19	1630	2485	<b>3.516 €</b>
<b>A3</b>	A3C-143183AC	4.01	1830	2200	<b>3.787 €</b>	A3C-143183AS	3.98	1830	2085	<b>3.326 €</b>
	A3C-143183BC	4.41	1830	2400	<b>3.974 €</b>	A3C-143183BS	4.38	1830	2285	<b>3.517 €</b>
	A3C-143183CC	4.81	1830	2600	<b>4.167 €</b>	A3C-143183CS	4.78	1830	2485	<b>3.702 €</b>
<b>A4</b>	A4C-143203AC	4.5	2030	2200	<b>4.006 €</b>	A4C-143203AS	4.47	2030	2085	<b>3.491 €</b>
	A4C-143203BC	4.95	2030	2400	<b>4.206 €</b>	A4C-143203BS	4.92	2030	2285	<b>3.691 €</b>
	A4C-143203CC	5.4	2030	2600	<b>4.408 €</b>	A4C-143203CS	5.37	2030	2485	<b>3.889 €</b>
<b>A5</b>	A5C-143223AC	4.99	2230	2200	<b>4.231 €</b>	A5C-143223AS	4.96	2230	2085	<b>3.661 €</b>
	A5C-143223BC	5.49	2230	2400	<b>4.437 €</b>	A5C-143223BS	5.46	2230	2285	<b>3.869 €</b>
	A5C-143223CC	5.99	2230	2600	<b>4.644 €</b>	A5C-143223CS	5.96	2230	2485	<b>4.076 €</b>
<b>A6</b>	A6C-143243AC	5.49	2430	2200	<b>4.449 €</b>	A6C-143243AS	5.44	2430	2085	<b>3.829 €</b>
	A6C-143243BC	6.03	2430	2400	<b>4.672 €</b>	A6C-143243BS	5.99	2430	2285	<b>4.046 €</b>
	A6C-143243CC	6.58	2430	2600	<b>4.894 €</b>	A6C-143243CS	6.54	2430	2485	<b>4.272 €</b>
<b>A7</b>	A7C-143263AC	5.98	2630	2200	<b>4.664 €</b>	A7C-143263AS	5.93	2630	2085	<b>3.995 €</b>
	A7C-143263BC	6.58	2630	2400	<b>4.902 €</b>	A7C-143263BS	6.53	2630	2285	<b>4.227 €</b>
	A7C-143263CC	7.17	2630	2600	<b>5.129 €</b>	A7C-143263CS	7.13	2630	2485	<b>4.452 €</b>
<b>A8</b>	A8C-143283AC	6.47	2830	2200	<b>4.888 €</b>	A8C-143283AS	6.42	2830	2085	<b>4.153 €</b>
	A8C-143283BC	7.12	2830	2400	<b>5.134 €</b>	A8C-143283BS	7.07	2830	2285	<b>4.398 €</b>
	A8C-143283CC	7.76	2830	2600	<b>5.372 €</b>	A8C-143283CS	7.72	2830	2485	<b>4.642 €</b>
<b>A9</b>	A9C-143303AC	6.96	3030	2200	<b>5.113 €</b>	A9C-143303AS	6.91	3030	2085	<b>4.326 €</b>
	A9C-143303BC	7.66	3030	2400	<b>5.360 €</b>	A9C-143303BS	7.61	3030	2285	<b>4.579 €</b>
	A9C-143303CC	8.35	3030	2600	<b>5.616 €</b>	A9C-143303CS	8.3	3030	2485	<b>4.835 €</b>
<b>A10</b>	A10C-143323AC	7.45	3230	2200	<b>5.324 €</b>	A10C-143323AS	7.4	3230	2085	<b>4.488 €</b>
	A10C-143323BC									



<b>80</b>	Largo - Length (L)																		
	1390	1590	1790	1990	2190	2390	2590	2790	2990	3190	3390	3590	3790	3990	4190	4390	4590	4790	4990
Fondo - Depth mm 1590	B1	B2	B3	B4	B5	B6	B7	B8	B9	B10	B11	B12	B13	B14	B15	B16	B17	B18	B19

<b>80</b>	CON suelo - WITH floor panel					SIN suelo - WITHOUT floor panel				
	COD	m³	L	H	€	COD	m³	L	H	€
<b>B1</b>	B1R-159139AC	4,09	1590	2160	3.271 €	B1R-159139AS	4,06	1590	2065	2.871 €
	B1R-159139BC	4,5	1590	2360	3.427 €	B1R-159139BS	4,47	1590	2265	3.033 €
	B1R-159139CC	4,91	1590	2560	3.590 €	B1R-159139CS	4,88	1590	2465	3.197 €
<b>B2</b>	B2R-159159AC	4,09	1590	2160	3.486 €	B2R-159159AS	4	1590	2065	3.026 €
	B2R-159159BC	4,5	1590	2360	3.664 €	B2R-159159BS	4	1590	2265	3.203 €
	B2R-159159CC	4,91	1590	2560	3.834 €	B2R-159159CS	5	1590	2465	3.371 €
<b>B3</b>	B3R-159179AC	4,66	1790	2160	3.710 €	B3R-159179AS	5	1790	2065	3.187 €
	B3R-159179BC	5,13	1790	2360	3.895 €	B3R-159179BS	5	1790	2265	3.368 €
	B3R-159179CC	5,59	1790	2560	4.073 €	B3R-159179CS	6	1790	2465	3.555 €
<b>B4</b>	B4R-159199AC	5,23	1990	2160	3.934 €	B4R-159199AS	5	1990	2065	3.344 €
	B4R-159199BC	5,76	1990	2360	4.120 €	B4R-159199BS	6	1990	2265	3.536 €
	B4R-159199CC	6,28	1990	2560	4.319 €	B4R-159199CS	6	1990	2465	3.729 €
<b>B5</b>	B5R-159219AC	5,81	2190	2160	4.150 €	B5R-159219AS	6	2190	2065	3.502 €
	B5R-159219BC	6,39	2190	2360	4.362 €	B5R-159219BS	6	2190	2265	3.706 €
	B5R-159219CC	6,97	2190	2560	4.564 €	B5R-159219CS	7	2190	2465	3.907 €
<b>B6</b>	B6R-159239AC	6,38	2390	2160	4.376 €	B6R-159239AS	6	2390	2065	3.661 €
	B6R-159239BC	7,02	2390	2360	4.588 €	B6R-159239BS	7	2390	2265	3.876 €
	B6R-159239CC	7,65	2390	2560	4.799 €	B6R-159239CS	8	2390	2465	4.092 €
<b>B7</b>	B7R-159259AC	6,95	2590	2160	4.600 €	B7R-159259AS	7	2590	2065	3.819 €
	B7R-159259BC	7,64	2590	2360	4.816 €	B7R-159259BS	8	2590	2265	4.050 €
	B7R-159259CC	8,34	2590	2560	5.039 €	B7R-159259CS	8	2590	2465	4.267 €
<b>B8</b>	B8R-159279AC	7,52	2790	2160	4.815 €	B8R-159279AS	7	2790	2065	3.982 €
	B8R-159279BC	8,27	2790	2360	5.054 €	B8R-159279BS	8	2790	2265	4.215 €
	B8R-159279CC	9,03	2790	2560	5.290 €	B8R-159279CS	9	2790	2465	4.448 €
<b>B9</b>	B9R-159299AC	8,09	2990	2160	5.035 €	B9R-159299AS	8	2990	2065	4.137 €
	B9R-159299BC	8,9	2990	2360	5.282 €	B9R-159299BS	9	2990	2265	4.381 €
	B9R-159299CC	9,71	2990	2560	5.531 €	B9R-159299CS	10	2990	2465	4.631 €
<b>B10</b>	B10R-159319AC	8,67	3190	2160	5.259 €	B10R-159319AS	9	3190	2065	4.303 €
	B10R-159319BC	9,53	3190	2360	5.509 €	B10R-159319BS	9	3190	2265	4.551 €
	B10R-159319CC	10,4	3190	2560	5.770 €	B10R-159319CS	10	3190	2465	4.812 €
<b>B11</b>	B11R-159339AC	9,24	3390	2160	5.482 €	B11R-159339AS	9	3390	2065	4.457 €
	B11R-159339BC	10,16	3390	2360	5.752 €	B11R-159339BS	10	3390	2265	4.726 €
	B11R-159339CC	11,09	3390	2560	6.010 €	B11R-159339CS	11	3390	2465	4.988 €
<b>B12</b>	B12R-159359AC	9,81	3590	2160	5.707 €	B12R-159359AS	10	3590	2065	4.620 €
	B12R-159359BC	10,79	3590	2360	5.984 €	B12R-159359BS	11	3590	2265	4.890 €
	B12R-159359CC	11,77	3590	2560	6.254 €	B12R-159359CS	12	3590	2465	5.166 €
<b>B13</b>	B13R-159379AC	10,38	3790	2160	6.091 €	B13R-159379AS	10,3	3790	2065	4.786 €
	B13R-159379BC	11,42	3790	2360	6.374 €	B13R-159379BS	11,34	3790	2265	5.070 €
	B13R-159379CC	12,46	3790	2560	6.658 €	B13R-159379CS	12,38	3790	2465	5.354 €
<b>B14</b>	B14R-159399AC	10,95	3990	2160	6.319 €	B14R-159399AS	10,87	3990	2065	4.938 €
	B14R-159399BC	12,05	3990	2360	6.614 €	B14R-159399BS	11,97	3990	2265	5.234 €
	B14R-159399CC	13,14	3990	2560	6.910 €	B14R-159399CS	13,06	3990	2465	5.530 €
<b>B15</b>	B15R-159419AC	11,53	4190	2160	6.545 €	B15R-159419AS	11,44	4190	2065	5.090 €
	B15R-159419BC	12,68	4190	2360	6.854 €	B15R-159419BS	12,59	4190	2265	5.399 €
	B15R-159419CC	13,83	4190	2560	7.163 €	B15R-159419CS	13,74	4190	2465	5.706 €
<b>B16</b>	B16R-159439AC	12,1	4390	2160	6.772 €	B16R-159439AS	12,01	4390	2065	5.242 €
	B16R-159439BC	13,31	4390	2360	7.092 €	B16R-159439BS	13,22	4390	2265	5.561 €
	B16R-159439CC	14,52	4390	2560	7.413 €	B16R-159439CS	14,43	4390	2465	5.884 €
<b>B17</b>	B17R-159459AC	12,67	4590	2160	6.997 €	B17R-159459AS	12,57	4590	2065	5.393 €
	B17R-159459BC	13,94	4590	2360	7.332 €	B17R-159459BS	13,84	4590	2265	5.725 €
	B17R-159459CC	15,2	4590	2560	7.667 €	B17R-159459CS	15,11	4590	2465	6.060 €
<b>B18</b>	B18R-159479AC	13,24	4790	2160	7.224 €	B18R-159479AS	13,14	4790	2065	5.542 €
	B18R-159479BC	14,57	4790	2360	7.571 €	B18R-159479BS	14,47	4790	2265	5.890 €
	B18R-159479CC	15,89	4790	2560	7.917 €	B18R-159479CS	15,79	4790	2465	6.236 €
<b>B19</b>	B19R-159499AC	13,81	4990	2160	7.452 €	B19R-159499AS	13,71	4990	2065	5.695 €
	B19R-159499BC	15,2	4990	2360	7.810 €	B19R-159499BS	15,09	4990	2265	6.055 €
	B19R-159499CC	16,58	4990	2560	8.169 €	B19R-159499CS	16,47	4990	2465	6.411 €

<b>100</b>	Largo - Length (L)																		
	1430	1630	1830	2030	2230	2430	2630	2830	3030	3230	3430	3630	3830	4030	4230	4430	4630	4830	5030
Fondo - Depth mm 1630	B1	B2	B3	B4	B5	B6	B7	B8	B9	B10	B11	B12	B13	B14	B15	B16	B17	B18	B19

<b>100</b>	CON suelo - WITH floor panel					SIN suelo - WITHOUT floor panel				
	COD	m³	L	H	€	COD	m³	L	H	€
<b>B1</b>	B1C-163143AC	4,09	1630	2200	3.563 €	B1C-163143AS	4,06	1630	2085	3.163 €
	B1C-163143BC	4,5	1630	2400	3.742 €	B1C-163143BS	4,47	1630	2285	3.342 €
	B1C-163143CC	4,91	1630	2600	3.919 €	B1C-163143CS	4,88	1630	2485	3.518 €
<b>B2</b>	B2C-163163AC	4,09	1630	2200	3.800 €	B2C-163163AS	4	1630	2085	3.334 €
	B2C-163163BC	4,5	1630	2400	3.987 €	B2C-163163BS	4	1630	2285	3.522 €
	B2C-163163CC	4,91	1630	2600	4.177 €	B2C-163163CS	5	1630	2485	3.710 €
<b>B3</b>	B3C-163183AC	4,66	1830	2200	4.040 €	B3C-163183AS	5	1830	2085	3.502 €
	B3C-163183BC	5,13	1830	2400	4.233 €	B3C-163183BS	5	1830	2285	3.701 €
	B3C-163183CC	5,59	1830	2600	4.437 €	B3C-163183CS	6	1830	2485	3.906 €
<b>B4</b>	B4C-163203AC	5,23	2030	2200	4.270 €	B4C-163203AS	5	2030	2085	3.680 €
	B4C-163203BC	5,76	2030	2400	4.480 €	B4C-163203BS	6	2030	2285	3.885 €
	B4C-163203CC	6,28	2030	2600	4.688 €	B4C-163203CS	6	2030	2485	4.100 €
<b>B5</b>	B5C-163223AC	5,81	2230	2200	4.509 €	B5C-163223AS	6	2230	2085	3.848 €
	B5C-163223BC	6,39	2230	2400	4.725 €	B5C-163223BS	6	2230	2285	4.073 €
	B5C-163223CC	6,97	2230	2600	4.950 €	B5C-163223CS	7	2230	2485	4.289 €
<b>B6</b>	B6C-163243AC	6,38	2430	2200	4.742 €	B6C-163243AS	6	2430	2085	4.020 €
	B6C-163243BC	7,02	2430	2400	4.968 €	B6C-163243BS	7	2430	2285	4.251 €
	B6C-163243CC	7,65	2430	2600	5.201 €	B6C-163243CS	8	2430	2485	4.487 €
<b>B7</b>	B7C-163263AC	6,95	2630	2200	4.971 €	B7C-163263AS	7	2630	2085	4.192 €
	B7C-163263BC	7,64	2630	2400	5.213 €	B7C-163263BS	8	2630	2285	4.428 €
	B7C-163263CC	8,34	2630	2600	5.463 €	B7C-163263CS	8	2630	2485	4.675 €
<b>B8</b>	B8C-163283AC	7,52	2830	2200	5.208 €	B8C-163283AS	7	2830	2085	4.358 €
	B8C-163283BC	8,27	2830	2400	5.465 €	B8C-163283BS	8	2830	2285	4.614 €
	B8C-163283CC	9,03	2830	2600	5.713 €	B8C-163283CS	9	2830	2485	4.870 €
<b>B9</b>	B9C-163303AC	8,09	3030	2200	5.442 €	B9C-163303AS	8	3030	2085	4.535 €
	B9C-163303BC	8,9	3030	2400	5.710 €	B9C-163303BS	9	3030	2285	4.799 €
	B9C-163303CC	9,71	3030	2600	5.974 €	B9C-163303CS	10	3030	2485	5.063 €
<b>B10</b>	B10C-163323AC	8,67	3230	2200	5.673 €	B10C-163323AS	9	3230	2085	4.701 €
	B10C-163323BC	9,53	3230	2400	5.956 €	B10C-163323BS	9	3230	2285	4.975 €
	B10C-163323CC	10,4	3230	2600	6.236 €	B10C-163323CS	10	3230	2485	5.258 €
<b>B11</b>	B11C-163343AC	9,24	3430	2200	5.917 €	B11C-163343AS	9	3430	2085	4.878 €
	B11C-163343BC	10,16	3430	2400	6.201 €	B11C-163343BS	10	3430	2285	5.166 €
	B11C-163343CC	11,09	3430	2600	6.481 €	B11C-163343CS	11	3430	2485	5.453 €
<b>B12</b>	B12C-163363AC	9,81	3630	2200	6.148 €	B12C-163363AS	10	3630	2085	5.051 €
	B12C-163363BC	10,79	3630	2400	6.442 €	B12C-163363BS	11	3630	2285	5.348 €
	B12C-163363CC	11,77	3630	2600						



<b>80</b>	Largo - Length (L)																		
	1390	1590	1790	1990	2190	2390	2590	2790	2990	3190	3390	3590	3790	3990	4190	4390	4590	4790	4990
Fondo - Depth mm 1790	C1	C2	C3	C4	C5	C6	C7	C8	C9	C10	C11	C12	C13	C14	C15	C16	C17	C18	C19

<b>80</b>	CON suelo - WITH floor panel					SIN suelo - WITHOUT floor panel				
	COD	m³	L	H	€	COD	m³	L	H	€
<b>C1</b>	C1R-179139AC	4,01	1390	2160	<b>3.475 €</b>	C1R-179139AS	3,98	1390	2065	<b>3.021 €</b>
	C1R-179139BC	4,41	1390	2360	<b>3.651 €</b>	C1R-179139BS	4,38	1390	2265	<b>3.196 €</b>
	C1R-179139CC	4,81	1390	2560	<b>3.820 €</b>	C1R-179139CS	4,78	1390	2465	<b>3.366 €</b>
<b>C2</b>	C2R-179159AC	4,66	1590	2160	<b>3.708 €</b>	C2R-179159AS	4,63	1590	2065	<b>3.187 €</b>
	C2R-179159BC	5,13	1590	2360	<b>3.892 €</b>	C2R-179159BS	5,09	1590	2265	<b>3.367 €</b>
	C2R-179159CC	5,59	1590	2560	<b>4.079 €</b>	C2R-179159CS	5,56	1590	2465	<b>3.554 €</b>
<b>C3</b>	C3R-179179AC	5,31	1790	2160	<b>3.945 €</b>	C3R-179179AS	5	1790	2065	<b>3.353 €</b>
	C3R-179179BC	5,85	1790	2360	<b>4.135 €</b>	C3R-179179BS	6	1790	2265	<b>3.547 €</b>
	C3R-179179CC	6,38	1790	2560	<b>4.331 €</b>	C3R-179179CS	6	1790	2465	<b>3.738 €</b>
<b>C4</b>	C4R-179199AC	5,97	1990	2160	<b>4.181 €</b>	C4R-179199AS	6	1990	2065	<b>3.513 €</b>
	C4R-179199BC	6,56	1990	2360	<b>4.388 €</b>	C4R-179199BS	7	1990	2265	<b>3.717 €</b>
	C4R-179199CC	7,16	1990	2560	<b>4.590 €</b>	C4R-179199CS	7	1990	2465	<b>3.923 €</b>
<b>C5</b>	C5R-179219AC	6,62	2190	2160	<b>4.419 €</b>	C5R-179219AS	7	2190	2065	<b>3.677 €</b>
	C5R-179219BC	7,28	2190	2360	<b>4.630 €</b>	C5R-179219BS	7	2190	2265	<b>3.895 €</b>
	C5R-179219CC	7,94	2190	2560	<b>4.848 €</b>	C5R-179219CS	8	2190	2465	<b>4.102 €</b>
<b>C6</b>	C6R-179239AC	7,27	2390	2160	<b>4.650 €</b>	C6R-179239AS	7	2390	2065	<b>3.842 €</b>
	C6R-179239BC	8	2390	2360	<b>4.870 €</b>	C6R-179239BS	8	2390	2265	<b>4.068 €</b>
	C6R-179239CC	8,72	2390	2560	<b>5.096 €</b>	C6R-179239CS	9	2390	2465	<b>4.288 €</b>
<b>C7</b>	C7R-179259AC	7,92	2590	2160	<b>4.888 €</b>	C7R-179259AS	8	2590	2065	<b>4.009 €</b>
	C7R-179259BC	8,71	2590	2360	<b>5.121 €</b>	C7R-179259BS	9	2590	2265	<b>4.239 €</b>
	C7R-179259CC	9,51	2590	2560	<b>5.354 €</b>	C7R-179259CS	9	2590	2465	<b>4.471 €</b>
<b>C8</b>	C8R-179279AC	8,57	2790	2160	<b>5.122 €</b>	C8R-179279AS	9	2790	2065	<b>4.171 €</b>
	C8R-179279BC	9,43	2790	2360	<b>5.367 €</b>	C8R-179279BS	9	2790	2265	<b>4.417 €</b>
	C8R-179279CC	10,29	2790	2560	<b>5.611 €</b>	C8R-179279CS	10	2790	2465	<b>4.662 €</b>
<b>C9</b>	C9R-179299AC	9,23	2990	2160	<b>5.354 €</b>	C9R-179299AS	9	2990	2065	<b>4.334 €</b>
	C9R-179299BC	10,15	2990	2360	<b>5.614 €</b>	C9R-179299BS	10	2990	2265	<b>4.585 €</b>
	C9R-179299CC	11,07	2990	2560	<b>5.863 €</b>	C9R-179299CS	11	2990	2465	<b>4.848 €</b>
<b>C10</b>	C10R-179319AC	9,88	3190	2160	<b>5.589 €</b>	C10R-179319AS	10	3190	2065	<b>4.502 €</b>
	C10R-179319BC	10,87	3190	2360	<b>5.861 €</b>	C10R-179319BS	11	3190	2265	<b>4.763 €</b>
	C10R-179319CC	11,85	3190	2560	<b>6.118 €</b>	C10R-179319CS	12	3190	2465	<b>5.027 €</b>
<b>C11</b>	C11R-179339AC	10,53	3390	2160	<b>5.821 €</b>	C11R-179339AS	10	3390	2065	<b>4.664 €</b>
	C11R-179339BC	11,58	3390	2360	<b>6.107 €</b>	C11R-179339BS	12	3390	2265	<b>4.937 €</b>
	C11R-179339CC	12,64	3390	2560	<b>6.379 €</b>	C11R-179339CS	13	3390	2465	<b>5.212 €</b>
<b>C12</b>	C12R-179359AC	11,18	3590	2160	<b>6.068 €</b>	C12R-179359AS	11	3590	2065	<b>4.828 €</b>
	C12R-179359BC	12,3	3590	2360	<b>6.346 €</b>	C12R-179359BS	12	3590	2265	<b>5.107 €</b>
	C12R-179359CC	13,42	3590	2560	<b>6.634 €</b>	C12R-179359CS	13	3590	2465	<b>5.395 €</b>
<b>C13</b>	C13R-179379AC	11,83	3790	2160	<b>6.298 €</b>	C13R-179379AS	12	3790	2065	<b>4.992 €</b>
	C13R-179379BC	13,02	3790	2360	<b>6.588 €</b>	C13R-179379BS	13	3790	2265	<b>5.287 €</b>
	C13R-179379CC	14,2	3790	2560	<b>6.884 €</b>	C13R-179379CS	14	3790	2465	<b>5.579 €</b>
<b>C14</b>	C14R-179399AC	12,49	3990	2160	<b>6.537 €</b>	C14R-179399AS	12,39	3990	2065	<b>5.157 €</b>
	C14R-179399BC	13,73	3990	2360	<b>6.839 €</b>	C14R-179399BS	13,64	3990	2265	<b>5.454 €</b>
	C14R-179399CC	14,98	3990	2560	<b>7.150 €</b>	C14R-179399CS	14,89	3990	2465	<b>5.762 €</b>
<b>C15</b>	C15R-179419AC	13,14	4190	2160	<b>6.980 €</b>	C15R-179419AS	13,04	4190	2065	<b>5.318 €</b>
	C15R-179419BC	14,45	4190	2360	<b>7.283 €</b>	C15R-179419BS	14,35	4190	2265	<b>5.635 €</b>
	C15R-179419CC	15,77	4190	2560	<b>7.596 €</b>	C15R-179419CS	15,67	4190	2465	<b>5.954 €</b>
<b>C16</b>	C16R-179439AC	13,79	4390	2160	<b>7.224 €</b>	C16R-179439AS	13,69	4390	2065	<b>5.478 €</b>
	C16R-179439BC	15,17	4390	2360	<b>7.533 €</b>	C16R-179439BS	15,07	4390	2265	<b>5.801 €</b>
	C16R-179439CC	16,55	4390	2560	<b>7.861 €</b>	C16R-179439CS	16,44	4390	2465	<b>6.129 €</b>
<b>C17</b>	C17R-179459AC	14,44	4590	2160	<b>7.471 €</b>	C17R-179459AS	14,33	4590	2065	<b>5.647 €</b>
	C17R-179459BC	15,89	4590	2360	<b>7.785 €</b>	C17R-179459BS	15,78	4590	2265	<b>5.987 €</b>
	C17R-179459CC	17,33	4590	2560	<b>8.125 €</b>	C17R-179459CS	17,22	4590	2465	<b>6.313 €</b>
<b>C18</b>	C18R-179479AC	15,09	4790	2160	<b>7.715 €</b>	C18R-179479AS	14,98	4790	2065	<b>5.809 €</b>
	C18R-179479BC	16,6	4790	2360	<b>8.037 €</b>	C18R-179479BS	16,49	4790	2265	<b>6.157 €</b>
	C18R-179479CC	18,11	4790	2560	<b>8.391 €</b>	C18R-179479CS	18	4790	2465	<b>6.504 €</b>
<b>C19</b>	C19R-179499AC	15,75	4990	2160	<b>7.962 €</b>	C19R-179499AS	15,63	4990	2065	<b>5.972 €</b>
	C19R-179499BC	17,32	4990	2360	<b>8.289 €</b>	C19R-179499BS	17,2	4990	2265	<b>6.327 €</b>
	C19R-179499CC	18,89	4990	2560	<b>8.656 €</b>	C19R-179499CS	18,78	4990	2465	<b>6.683 €</b>

<b>100</b>	Largo - Length (L)																		
	1430	1630	1830	2030	2230	2430	2630	2830	3030	3230	3430	3630	3830	4030	4230	4430	4630	4830	5030
Fondo - Depth mm 1830	C1	C2	C3	C4	C5	C6	C7	C8	C9	C10	C11	C12	C13	C14	C15	C16	C17	C18	C19

<b>100</b>	CON suelo - WITH floor panel					SIN suelo - WITHOUT floor panel				
	COD	m³	L	H	€	COD	m³	L	H	€
<b>C1</b>	C1C-183143AC	4,01	1430	2200	<b>3.790 €</b>	C1C-183143AS	3,98	1430	2085	<b>3.327 €</b>
	C1C-183143BC	4,41	1430	2400	<b>3.977 €</b>	C1C-183143BS	4,38	1430	2285	<b>3.518 €</b>
	C1C-183143CC	4,81	1430	2600	<b>4.160 €</b>	C1C-183143CS	4,78	1430	2485	<b>3.702 €</b>
<b>C2</b>	C2C-183163AC	4,66	1630	2200	<b>4.035 €</b>	C2C-183163AS	4,63	1630	2085	<b>3.504 €</b>
	C2C-183163BC	5,13	1630	2400	<b>4.235 €</b>	C2C-183163BS	5,09	1630	2285	<b>3.700 €</b>
	C2C-183163CC	5,59	1630	2600	<b>4.434 €</b>	C2C-183163CS	5,56	1630	2485	<b>3.906 €</b>
<b>C3</b>	C3C-183183AC	5,31	1830	2200	<b>4.283 €</b>	C3C-183183AS	5	1830	2085	<b>3.679 €</b>
	C3C-183183BC	5,85	1830	2400	<b>4.493 €</b>	C3C-183183BS	6	1830	2285	<b>3.891 €</b>
	C3C-183183CC	6,38	1830	2600	<b>4.706 €</b>	C3C-183183CS	6	1830	2485	<b>4.100 €</b>
<b>C4</b>	C4C-183203AC	5,97	2030	2200	<b>4.530 €</b>	C4C-183203AS	6	2030	2085	<b>3.857 €</b>
	C4C-183203BC	6,56	2030	2400	<b>4.757 €</b>	C4C-183203BS	7	2030	2285	<b>4.077 €</b>
	C4C-183203CC	7,16	2030	2600	<b>4.973 €</b>	C4C-183203CS	7	2030	2485	<b>4.298 €</b>
<b>C5</b>	C5C-183223AC	6,62	2230	2200	<b>4.782 €</b>	C5C-183223AS	7	2230	2085	<b>4.035 €</b>
	C5C-183223BC	7,28	2230	2400	<b>5.018 €</b>	C5C-183223BS	7	2230	2285	<b>4.267 €</b>
	C5C-183223CC	7,94	2230	2600	<b>5.247 €</b>	C5C-183223CS	8	2230	2485	<b>4.499 €</b>
<b>C6</b>	C6C-183243AC	7,27	2430	2200	<b>5.026 €</b>	C6C-183243AS	7	2430	2085	<b>4.211 €</b>
	C6C-183243BC	8	2430	2400	<b>5.269 €</b>	C6C-183243BS	8	2430	2285	<b>4.458 €</b>
	C6C-183243CC	8,72	2430	2600	<b>5.517 €</b>	C6C-183243CS	9	2430	2485	<b>4.697 €</b>
<b>C7</b>	C7C-183263AC	7,92	2630	2200	<b>5.280 €</b>	C7C-183263AS	8	2630	2085	<b>4.385 €</b>
	C7C-183263BC	8,71	2630	2400	<b>5.539 €</b>	C7C-183263BS	9	2630	2285	<b>4.644 €</b>
	C7C-183263CC	9,51	2630	2600	<b>5.790 €</b>	C7C-183263CS	9	2630	2485	<b>4.898 €</b>
<b>C8</b>	C8C-183283AC	8,57	2830	2200	<b>5.524 €</b>	C8C-183283AS	9	2830	2085	<b>4.568 €</b>
	C8C-183283BC	9,43	2830	2400	<b>5.792 €</b>	C8C-183283BS	9	2830	2285	<b>4.831 €</b>
	C8C-183283CC	10,29	2830	2600	<b>6.058 €</b>	C8C-183283CS	10	2830	2485	<b>5.099 €</b>
<b>C9</b>	C9C-183303AC	9,23	3030	2200	<b>5.778 €</b>	C9C-183303AS	9	3030	2085	<b>4.738 €</b>
	C9C-183303BC	10,15	3030	2400	<b>6.051 €</b>	C9C-183303BS	10	3030	2285	<b>5.019 €</b>
	C9C-183303CC	11,07	3030	2600	<b>6.335 €</b>	C9C-183303CS	11	3030	2485	<b>5.291 €</b>
<b>C10</b>	C10C-183323AC	9,88	3230	2200	<b>6.024 €</b>	C10C-183323AS	10	3230	2085	<b>4.920 €</b>
	C10C-183323BC	10,87	3230	2400	<b>6.317 €</b>	C10C-183323BS	11	3230	2285	<b>5.209 €</b>
	C10C-183323CC	11,85	3230	2600	<b>6.600 €</b>					



<b>80</b>	Largo - Length (L)																		
	1390	1590	1790	1990	2190	2390	2590	2790	2990	3190	3390	3590	3790	3990	4190	4390	4590	4790	4990
Fondo - Depth mm 1990	D1	D2	D3	D4	D5	D6	D7	D8	D9	D10	D11	D12	D13	D14	D15	D16	D17	D18	D19

<b>80</b>	CON suelo - WITH floor panel					SIN suelo - WITHOUT floor panel				
	COD	m³	L	H	€	COD	m³	L	H	€
<b>D1</b>	D1R-199139AC	4,5	1390	2160	<b>3.683 €</b>	D1R-199139AS	4,47	1390	2065	<b>3.180 €</b>
	D1R-199139BC	4,95	1390	2360	<b>3.867 €</b>	D1R-199139BS	4,92	1390	2265	<b>3.360 €</b>
	D1R-199139CC	5,4	1390	2560	<b>4.051 €</b>	D1R-199139CS	5,37	1390	2465	<b>3.546 €</b>
<b>D2</b>	D2R-199159AC	5,23	1590	2160	<b>3.928 €</b>	D2R-199159AS	5,19	1590	2065	<b>3.345 €</b>
	D2R-199159BC	5,76	1590	2360	<b>4.127 €</b>	D2R-199159BS	5,72	1590	2265	<b>3.539 €</b>
	D2R-199159CC	6,28	1590	2560	<b>4.320 €</b>	D2R-199159CS	6,24	1590	2465	<b>3.735 €</b>
<b>D3</b>	D3R-199179AC	5,97	1790	2160	<b>4.181 €</b>	D3R-199179AS	5,92	1790	2065	<b>3.518 €</b>
	D3R-199179BC	6,56	1790	2360	<b>4.386 €</b>	D3R-199179BS	6,52	1790	2265	<b>3.718 €</b>
	D3R-199179CC	7,16	1790	2560	<b>4.591 €</b>	D3R-199179CS	7,11	1790	2465	<b>3.924 €</b>
<b>D4</b>	D4R-199199AC	6,7	1990	2160	<b>4.425 €</b>	D4R-199199AS	6,65	1990	2065	<b>3.680 €</b>
	D4R-199199BC	7,37	1990	2360	<b>4.648 €</b>	D4R-199199BS	7,32	1990	2265	<b>3.897 €</b>
	D4R-199199CC	8,04	1990	2560	<b>4.857 €</b>	D4R-199199CS	7,99	1990	2465	<b>4.108 €</b>
<b>D5</b>	D5R-199219AC	7,43	2190	2160	<b>4.677 €</b>	D5R-199219AS	7,37	2190	2065	<b>3.852 €</b>
	D5R-199219BC	8,17	2190	2360	<b>4.902 €</b>	D5R-199219BS	8,12	2190	2265	<b>4.072 €</b>
	D5R-199219CC	8,92	2190	2560	<b>5.131 €</b>	D5R-199219CS	8,86	2190	2465	<b>4.303 €</b>
<b>D6</b>	D6R-199239AC	8,16	2390	2160	<b>4.927 €</b>	D6R-199239AS	8,1	2390	2065	<b>4.019 €</b>
	D6R-199239BC	8,98	2390	2360	<b>5.158 €</b>	D6R-199239BS	8,92	2390	2265	<b>4.257 €</b>
	D6R-199239CC	9,79	2390	2560	<b>5.393 €</b>	D6R-199239CS	9,73	2390	2465	<b>4.486 €</b>
<b>D7</b>	D7R-199259AC	8,89	2590	2160	<b>5.173 €</b>	D7R-199259AS	8,83	2590	2065	<b>4.190 €</b>
	D7R-199259BC	9,78	2590	2360	<b>5.421 €</b>	D7R-199259BS	9,72	2590	2265	<b>4.436 €</b>
	D7R-199259CC	10,67	2590	2560	<b>5.668 €</b>	D7R-199259CS	10,61	2590	2465	<b>4.680 €</b>
<b>D8</b>	D8R-199279AC	9,63	2790	2160	<b>5.430 €</b>	D8R-199279AS	9,55	2790	2065	<b>4.355 €</b>
	D8R-199279BC	10,59	2790	2360	<b>5.684 €</b>	D8R-199279BS	10,52	2790	2265	<b>4.616 €</b>
	D8R-199279CC	11,55	2790	2560	<b>5.930 €</b>	D8R-199279CS	11,48	2790	2465	<b>4.874 €</b>
<b>D9</b>	D9R-199299AC	10,36	2990	2160	<b>5.678 €</b>	D9R-199299AS	10,28	2990	2065	<b>4.528 €</b>
	D9R-199299BC	11,39	2990	2360	<b>5.943 €</b>	D9R-199299BS	11,32	2990	2265	<b>4.791 €</b>
	D9R-199299CC	12,43	2990	2560	<b>6.200 €</b>	D9R-199299CS	12,35	2990	2465	<b>5.054 €</b>
<b>D10</b>	D10R-199319AC	11,09	3190	2160	<b>5.919 €</b>	D10R-199319AS	11,01	3190	2065	<b>4.702 €</b>
	D10R-199319BC	12,2	3190	2360	<b>6.193 €</b>	D10R-199319BS	12,12	3190	2265	<b>4.968 €</b>
	D10R-199319CC	13,31	3190	2560	<b>6.476 €</b>	D10R-199319CS	13,22	3190	2465	<b>5.253 €</b>
<b>D11</b>	D11R-199339AC	11,82	3390	2160	<b>6.166 €</b>	D11R-199339AS	11,73	3390	2065	<b>4.867 €</b>
	D11R-199339BC	13	3390	2360	<b>6.452 €</b>	D11R-199339BS	12,92	3390	2265	<b>5.150 €</b>
	D11R-199339CC	14,19	3390	2560	<b>6.748 €</b>	D11R-199339CS	14,1	3390	2465	<b>5.435 €</b>
<b>D12</b>	D12R-199359AC	12,55	3590	2160	<b>6.419 €</b>	D12R-199359AS	12,46	3590	2065	<b>5.034 €</b>
	D12R-199359BC	13,81	3590	2360	<b>6.710 €</b>	D12R-199359BS	13,72	3590	2265	<b>5.335 €</b>
	D12R-199359CC	15,06	3590	2560	<b>7.011 €</b>	D12R-199359CS	14,97	3590	2465	<b>5.621 €</b>
<b>D13</b>	D13R-199379AC	13,29	3790	2160	<b>6.665 €</b>	D13R-199379AS	13,19	3790	2065	<b>5.200 €</b>
	D13R-199379BC	14,61	3790	2360	<b>6.975 €</b>	D13R-199379BS	14,51	3790	2265	<b>5.516 €</b>
	D13R-199379CC	15,94	3790	2560	<b>7.350 €</b>	D13R-199379CS	15,84	3790	2465	<b>5.811 €</b>
<b>D14</b>	D14R-199399AC	14,02	3990	2160	<b>6.926 €</b>	D14R-199399AS	13,91	3990	2065	<b>5.370 €</b>
	D14R-199399BC	15,42	3990	2360	<b>7.238 €</b>	D14R-199399BS	15,31	3990	2265	<b>5.691 €</b>
	D14R-199399CC	16,82	3990	2560	<b>7.609 €</b>	D14R-199399CS	16,72	3990	2465	<b>6.006 €</b>
<b>D15</b>	D15R-199419AC	14,75	4190	2160	<b>7.162 €</b>	D15R-199419AS	14,64	4190	2065	<b>5.542 €</b>
	D15R-199419BC	16,22	4190	2360	<b>7.500 €</b>	D15R-199419BS	16,11	4190	2265	<b>5.865 €</b>
	D15R-199419CC	17,7	4190	2560	<b>7.881 €</b>	D15R-199419CS	17,59	4190	2465	<b>6.198 €</b>
<b>D16</b>	D16R-199439AC	15,48	4390	2160	<b>7.415 €</b>	D16R-199439AS	15,37	4390	2065	<b>5.707 €</b>
	D16R-199439BC	17,03	4390	2360	<b>7.748 €</b>	D16R-199439BS	16,91	4390	2265	<b>6.044 €</b>
	D16R-199439CC	18,58	4390	2560	<b>8.143 €</b>	D16R-199439CS	18,46	4390	2465	<b>6.391 €</b>
<b>D17</b>	D17R-199459AC	16,21	4590	2160	<b>7.668 €</b>	D17R-199459AS	16,09	4590	2065	<b>5.877 €</b>
	D17R-199459BC	17,84	4590	2360	<b>8.012 €</b>	D17R-199459BS	17,71	4590	2265	<b>6.230 €</b>
	D17R-199459CC	19,46	4590	2560	<b>8.414 €</b>	D17R-199459CS	19,33	4590	2465	<b>6.571 €</b>
<b>D18</b>	D18R-199479AC	16,95	4790	2160	<b>7.908 €</b>	D18R-199479AS	16,82	4790	2065	<b>6.046 €</b>
	D18R-199479BC	18,64	4790	2360	<b>8.262 €</b>	D18R-199479BS	18,51	4790	2265	<b>6.409 €</b>
	D18R-199479CC	20,33	4790	2560	<b>8.697 €</b>	D18R-199479CS	20,21	4790	2465	<b>6.757 €</b>
<b>D19</b>	D19R-199499AC	17,68	4990	2160	<b>8.157 €</b>	D19R-199499AS	17,55	4990	2065	<b>6.213 €</b>
	D19R-199499BC	19,45	4990	2360	<b>8.534 €</b>	D19R-199499BS	19,31	4990	2265	<b>6.594 €</b>
	D19R-199499CC	21,21	4990	2560	<b>8.955 €</b>	D19R-199499CS	21,08	4990	2465	<b>6.947 €</b>

<b>100</b>	Largo - Length (L)																		
	1430	1630	1830	2030	2230	2430	2630	2830	3030	3230	3430	3630	3830	4030	4230	4430	4630	4830	5030
Fondo - Depth mm 2030	D1	D2	D3	D4	D5	D6	D7	D8	D9	D10	D11	D12	D13	D14	D15	D16	D17	D18	D19

<b>100</b>	CON suelo - WITH floor panel					SIN suelo - WITHOUT floor panel				
	COD	m³	L	H	€	COD	m³	L	H	€
<b>D1</b>	D1C-203143AC	4,5	1430	2200	<b>4.004 €</b>	D1C-203143AS	4,47	1430	2085	<b>3.495 €</b>
	D1C-203143BC	4,95	1430	2400	<b>4.210 €</b>	D1C-203143BS	4,92	1430	2285	<b>3.691 €</b>
	D1C-203143CC	5,4	1430	2600	<b>4.406 €</b>	D1C-203143CS	5,37	1430	2485	<b>3.889 €</b>
<b>D2</b>	D2C-203163AC	5,23	1630	2200	<b>4.275 €</b>	D2C-203163AS	5,19	1630	2085	<b>3.680 €</b>
	D2C-203163BC	5,76	1630	2400	<b>4.481 €</b>	D2C-203163BS	5,72	1630	2285	<b>3.885 €</b>
	D2C-203163CC	6,28	1630	2600	<b>4.686 €</b>	D2C-203163CS	6,24	1630	2485	<b>4.097 €</b>
<b>D3</b>	D3C-203183AC	5,97	1830	2200	<b>4.532 €</b>	D3C-203183AS	5,92	1830	2085	<b>3.861 €</b>
	D3C-203183BC	6,56	1830	2400	<b>4.753 €</b>	D3C-203183BS	6,52	1830	2285	<b>4.083 €</b>
	D3C-203183CC	7,16	1830	2600	<b>4.971 €</b>	D3C-203183CS	7,11	1830	2485	<b>4.297 €</b>
<b>D4</b>	D4C-203203AC	6,7	2030	2200	<b>4.797 €</b>	D4C-203203AS	6,65	2030	2085	<b>4.037 €</b>
	D4C-203203BC	7,37	2030	2400	<b>5.023 €</b>	D4C-203203BS	7,32	2030	2285	<b>4.273 €</b>
	D4C-203203CC	8,04	2030	2600	<b>5.261 €</b>	D4C-203203CS	7,99	2030	2485	<b>4.508 €</b>
<b>D5</b>	D5C-203223AC	7,43	2230	2200	<b>5.057 €</b>	D5C-203223AS	7,37	2230	2085	<b>4.227 €</b>
	D5C-203223BC	8,17	2230	2400	<b>5.303 €</b>	D5C-203223BS	8,12	2230	2285	<b>4.469 €</b>
	D5C-203223CC	8,92	2230	2600	<b>5.547 €</b>	D5C-203223CS	8,86	2230	2485	<b>4.706 €</b>
<b>D6</b>	D6C-203243AC	8,16	2430	2200	<b>5.318 €</b>	D6C-203243AS	8,1	2430	2085	<b>4.402 €</b>
	D6C-203243BC	8,98	2430	2400	<b>5.574 €</b>	D6C-203243BS	8,92	2430	2285	<b>4.659 €</b>
	D6C-203243CC	9,79	2430	2600	<b>5.828 €</b>	D6C-203243CS	9,73	2430	2485	<b>4.918 €</b>
<b>D7</b>	D7C-203263AC	8,89	2630	2200	<b>5.579 €</b>	D7C-203263AS	8,83	2630	2085	<b>4.588 €</b>
	D7C-203263BC	9,78	2630	2400	<b>5.856 €</b>	D7C-203263BS	9,72	2630	2285	<b>4.854 €</b>
	D7C-203263CC	10,67	2630	2600	<b>6.118 €</b>	D7C-203263CS	10,61	2630	2485	<b>5.121 €</b>
<b>D8</b>	D8C-203283AC	9,63	2830	2200	<b>5.850 €</b>	D8C-203283AS	9,55	2830	2085	<b>4.774 €</b>
	D8C-203283BC	10,59	2830	2400	<b>6.123 €</b>	D8C-203283BS	10,52	2830	2285	<b>5.042 €</b>
	D8C-203283CC	11,55	2830	2600	<b>6.396 €</b>	D8C-203283CS	11,48	2830	2485	<b>5.319 €</b>
<b>D9</b>	D9C-203303AC	10,36	3030	2200	<b>6.116 €</b>	D9C-203303AS	10,28	3030	2085	<b>4.955 €</b>
	D9C-203303BC	11,39	3030	2400	<b>6.404 €</b>	D9C-203303BS	11,32	3030	2285	<b>5.242 €</b>
	D9C-203303CC	12,43	3030	2600	<b>6.685 €</b>	D9C-203303CS	12,35	3030	2485	<b>5.529 €</b>
<b>D10</b>	D10C-203323AC	11,09	3230	2200	<b>6.370 €</b>	D10C-203323AS	11,01			



80	Largo - Length (L)																		
	1390	1590	1790	1990	2190	2390	2590	2790	2990	3190	3390	3590	3790	3990	4190	4390	4590	4790	4990
Fondo - Depth mm 2190	E1	E2	E3	E4	E5	E6	E7	E8	E9	E10	E11	E12	E13	E14	E15	E16	E17	E18	E19

80	CON suelo - WITH floor panel					SIN suelo - WITHOUT floor panel				
	COD	m³	L	H	€	COD	m³	L	H	€
E1	E1R-219139AC	4,99	1390	2160	3.892 €	E1R-219139AS	4,96	1390	2065	3.333 €
	E1R-219139BC	5,49	1390	2360	4.081 €	E1R-219139BS	5,46	1390	2265	3.527 €
	E1R-219139CC	5,99	1390	2560	4.273 €	E1R-219139CS	5,96	1390	2465	3.718 €
E2	E2R-219159AC	5,81	1590	2160	4.149 €	E2R-219159AS	5,76	1590	2065	3.504 €
	E2R-219159BC	6,39	1590	2360	4.359 €	E2R-219159BS	6,34	1590	2265	3.707 €
	E2R-219159CC	6,97	1590	2560	4.562 €	E2R-219159CS	6,92	1590	2465	3.910 €
E3	E3R-219179AC	6,62	1790	2160	4.415 €	E3R-219179AS	6,57	1790	2065	3.676 €
	E3R-219179BC	7,28	1790	2360	4.634 €	E3R-219179BS	7,23	1790	2265	3.894 €
	E3R-219179CC	7,94	1790	2560	4.845 €	E3R-219179CS	7,89	1790	2465	4.104 €
E4	E4R-219199AC	7,43	1990	2160	4.675 €	E4R-219199AS	7,37	1990	2065	3.851 €
	E4R-219199BC	8,17	1990	2360	4.906 €	E4R-219199BS	8,12	1990	2265	4.080 €
	E4R-219199CC	8,92	1990	2560	5.128 €	E4R-219199CS	8,86	1990	2465	4.302 €
E5	E5R-219219AC	8,24	2190	2160	4.947 €	E5R-219219AS	8	2190	2065	4.030 €
	E5R-219219BC	9,07	2190	2360	5.180 €	E5R-219219BS	9	2190	2265	4.256 €
	E5R-219219CC	9,89	2190	2560	5.404 €	E5R-219219CS	10	2190	2465	4.495 €
E6	E6R-219239AC	9,05	2390	2160	5.209 €	E6R-219239AS	9	2390	2065	4.201 €
	E6R-219239BC	9,96	2390	2360	5.451 €	E6R-219239BS	10	2390	2265	4.450 €
	E6R-219239CC	10,86	2390	2560	5.689 €	E6R-219239CS	11	2390	2465	4.688 €
E7	E7R-219259AC	9,87	2590	2160	5.465 €	E7R-219259AS	10	2590	2065	4.377 €
	E7R-219259BC	10,85	2590	2360	5.717 €	E7R-219259BS	11	2590	2265	4.625 €
	E7R-219259CC	11,84	2590	2560	5.973 €	E7R-219259CS	12	2590	2465	4.880 €
E8	E8R-219279AC	10,68	2790	2160	5.727 €	E8R-219279AS	11	2790	2065	4.545 €
	E8R-219279BC	11,75	2790	2360	5.991 €	E8R-219279BS	12	2790	2265	4.816 €
	E8R-219279CC	12,81	2790	2560	6.254 €	E8R-219279CS	13	2790	2465	5.074 €
E9	E9R-219299AC	11,49	2990	2160	5.993 €	E9R-219299AS	11	2990	2065	4.720 €
	E9R-219299BC	12,64	2990	2360	6.262 €	E9R-219299BS	13	2990	2265	4.997 €
	E9R-219299CC	13,79	2990	2560	6.544 €	E9R-219299CS	14	2990	2465	5.272 €
E10	E10R-219319AC	12,3	3190	2160	6.252 €	E10R-219319AS	12	3190	2065	4.893 €
	E10R-219319BC	13,53	3190	2360	6.541 €	E10R-219319BS	13	3190	2265	5.179 €
	E10R-219319CC	14,76	3190	2560	6.831 €	E10R-219319CS	15	3190	2465	5.474 €
E11	E11R-219339AC	13,11	3390	2160	6.515 €	E11R-219339AS	13	3390	2065	5.074 €
	E11R-219339BC	14,43	3390	2360	6.812 €	E11R-219339BS	14	3390	2265	5.366 €
	E11R-219339CC	15,74	3390	2560	7.114 €	E11R-219339CS	16	3390	2465	5.668 €
E12	E12R-219359AC	13,93	3590	2160	6.778 €	E12R-219359AS	14	3590	2065	5.245 €
	E12R-219359BC	15,32	3590	2360	7.093 €	E12R-219359BS	15	3590	2265	5.552 €
	E12R-219359CC	16,71	3590	2560	7.455 €	E12R-219359CS	17	3590	2465	5.860 €
E13	E13R-219379AC	14,74	3790	2160	7.048 €	E13R-219379AS	15	3790	2065	5.424 €
	E13R-219379BC	16,21	3790	2360	7.433 €	E13R-219379BS	16	3790	2265	5.735 €
	E13R-219379CC	17,69	3790	2560	7.732 €	E13R-219379CS	18	3790	2465	6.047 €
E14	E14R-219399AC	15,55	3990	2160	7.304 €	E14R-219399AS	15	3990	2065	5.599 €
	E14R-219399BC	17,1	3990	2360	7.687 €	E14R-219399BS	17	3990	2265	5.917 €
	E14R-219399CC	18,66	3990	2560	8.017 €	E14R-219399CS	19	3990	2465	6.241 €
E15	E15R-219419AC	16,36	4190	2160	7.630 €	E15R-219419AS	16	4190	2065	5.767 €
	E15R-219419BC	18	4190	2360	7.960 €	E15R-219419BS	18	4190	2265	6.102 €
	E15R-219419CC	19,63	4190	2560	8.282 €	E15R-219419CS	20	4190	2465	6.439 €
E16	E16R-219439AC	17,17	4390	2160	7.901 €	E16R-219439AS	17	4390	2065	5.943 €
	E16R-219439BC	18,89	4390	2360	8.230 €	E16R-219439BS	19	4390	2265	6.292 €
	E16R-219439CC	20,61	4390	2560	8.578 €	E16R-219439CS	20	4390	2465	6.633 €
E17	E17R-219459AC	17,99	4590	2160	8.147 €	E17R-219459AS	18	4590	2065	6.116 €
	E17R-219459BC	19,78	4590	2360	8.498 €	E17R-219459BS	20	4590	2265	6.479 €
	E17R-219459CC	21,58	4590	2560	8.847 €	E17R-219459CS	21	4590	2465	6.826 €
E18	E18R-219479AC	18,8	4790	2160	8.423 €	E18R-219479AS	19	4790	2065	6.287 €
	E18R-219479BC	20,68	4790	2360	8.779 €	E18R-219479BS	21	4790	2265	6.657 €
	E18R-219479CC	22,56	4790	2560	9.143 €	E18R-219479CS	22	4790	2465	7.020 €
E19	E19R-219499AC	19,61	4990	2160	8.675 €	E19R-219499AS	19	4990	2065	6.467 €
	E19R-219499BC	21,57	4990	2360	9.051 €	E19R-219499BS	21	4990	2265	6.841 €
	E19R-219499CC	23,53	4990	2560	9.421 €	E19R-219499CS	23	4990	2465	7.227 €

100	Largo - Length (L)																			
	1430	1630	1830	2030	2230	2430	2630	2830	3030	3230	3430	3630	3830	4030	4230	4430	4630	4830	5030	
Fondo - Depth mm 2230	E1	E2	E3	E4	E5	E6	E7	E8	E9	E10	E11	E12	E13	E14	E15	E16	E17	E18	E19	

100	CON suelo - WITH floor panel					SIN suelo - WITHOUT floor panel				
	COD	m³	L	H	€	COD	m³	L	H	€
E1	E1C-223143AC	4,99	1430	2200	4.231 €	E1C-223143AS	4,96	1430	2085	3.657 €
	E1C-223143BC	5,49	1430	2400	4.435 €	E1C-223143BS	5,46	1430	2285	3.866 €
	E1C-223143CC	5,99	1430	2600	4.651 €	E1C-223143CS	5,96	1430	2485	4.079 €
E2	E2C-223163AC	5,81	1630	2200	4.509 €	E2C-223163AS	5,76	1630	2085	3.851 €
	E2C-223163BC	6,39	1630	2400	4.730 €	E2C-223163BS	6,34	1630	2285	4.066 €
	E2C-223163CC	6,97	1630	2600	4.949 €	E2C-223163CS	6,92	1630	2485	4.295 €
E3	E3C-223183AC	6,62	1830	2200	4.781 €	E3C-223183AS	6,57	1830	2085	4.035 €
	E3C-223183BC	7,28	1830	2400	5.017 €	E3C-223183BS	7,23	1830	2285	4.271 €
	E3C-223183CC	7,94	1830	2600	5.242 €	E3C-223183CS	7,89	1830	2485	4.499 €
E4	E4C-223203AC	7,43	2030	2200	5.059 €	E4C-223203AS	7,37	2030	2085	4.226 €
	E4C-223203BC	8,17	2030	2400	5.306 €	E4C-223203BS	8,12	2030	2285	4.465 €
	E4C-223203CC	8,92	2030	2600	5.550 €	E4C-223203CS	8,86	2030	2485	4.711 €
E5	E5C-223223AC	8,24	2230	2200	5.333 €	E5C-223223AS	8	2230	2085	4.413 €
	E5C-223223BC	9,07	2230	2400	5.585 €	E5C-223223BS	9	2230	2285	4.664 €
	E5C-223223CC	9,89	2230	2600	5.845 €	E5C-223223CS	10	2230	2485	4.924 €
E6	E6C-223243AC	9,05	2430	2200	5.618 €	E6C-223243AS	9	2430	2085	4.600 €
	E6C-223243BC	9,96	2430	2400	5.877 €	E6C-223243BS	10	2430	2285	4.860 €
	E6C-223243CC	10,86	2430	2600	6.142 €	E6C-223243CS	11	2430	2485	5.126 €
E7	E7C-223263AC	9,87	2630	2200	5.887 €	E7C-223263AS	10	2630	2085	4.788 €
	E7C-223263BC	10,85	2630	2400	6.170 €	E7C-223263BS	11	2630	2285	5.066 €
	E7C-223263CC	11,84	2630	2600	6.442 €	E7C-223263CS	12	2630	2485	5.343 €
E8	E8C-223283AC	10,68	2830	2200	6.165 €	E8C-223283AS	11	2830	2085	4.977 €
	E8C-223283BC	11,75	2830	2400	6.461 €	E8C-223283BS	12	2830	2285	5.262 €
	E8C-223283CC	12,81	2830	2600	6.740 €	E8C-223283CS	13	2830	2485	5.552 €
E9	E9C-223303AC	11,49	3030	2200	6.437 €	E9C-223303AS	11	3030	2085	5.165 €
	E9C-223303BC	12,64	3030	2400	6.741 €	E9C-223303BS	13	3030	2285	5.457 €
	E9C-223303CC	13,79	3030	2600	7.052 €	E9C-223303CS	14	3030	2485	5.757 €
E10	E10C-223323AC	12,3	3230	2200	6.726 €	E10C-223323AS	12	3230	2085	5.351 €
	E10C-223323BC	13,53	3230	2400	7.029 €	E10C-223323BS	13	3230	2285	5.660 €
	E10C-223323CC	14,76	3230	2600	7.346 €	E10C-223323CS	15	3230	2485	5.970 €
E11	E11C-223343AC	13,11	3430	2200	7.208 €	E11C-223343AS	13	3430	2085	5.533 €
	E11C-223343BC	14,43	3430	2400	7.525 €	E11C-223343BS	14	3430	2285	5.863 €
	E11C-223343CC	15,74	3430	2600	7.848 €	E11C-223343CS	16	3430	2485	6.184 €
E12	E12C-223363AC	13,93	3630	2200	7.484 €	E12C-223363AS	14	3630	2085	5.730 €
	E12C-223363BC	15,32	3630	2400	7.804 €	E12C-223363BS	15	3630	2285	6.052 €
	E12C-223363CC	16,71	3630	2600	8.126					



<b>80</b>	Largo - Length (L)																			
	1390	1590	1790	1990	2190	2390	2590	2790	2990	3190	3390	3590	3790	3990	4190	4390	4590	4790	4990	
Fondo - Depth mm	2390	F1	F2	F3	F4	F5	F6	F7	F8	F9	F10	F11	F12	F13	F14	F15	F16	F17	F18	F19

<b>80</b>	CON suelo - WITH floor panel					SIN suelo - WITHOUT floor panel				
	COD	m³	L	H	€	COD	m³	L	H	€
<b>F1</b>	F1R-239139AC	5,49	1390	2160	4.099 €	F1R-239139AS	5,44	1390	2065	3.486 €
	F1R-239139BC	6,03	1390	2360	4.302 €	F1R-239139BS	5,99	1390	2265	3.684 €
	F1R-239139CC	6,58	1390	2560	4.508 €	F1R-239139CS	6,54	1390	2465	3.888 €
<b>F2</b>	F2R-239159AC	6,38	1590	2160	4.372 €	F2R-239159AS	6,33	1590	2065	3.663 €
	F2R-239159BC	7,02	1590	2360	4.588 €	F2R-239159BS	6,97	1590	2265	3.881 €
	F2R-239159CC	7,65	1590	2560	4.797 €	F2R-239159CS	7,61	1590	2465	4.089 €
<b>F3</b>	F3R-239179AC	7,27	1790	2160	4.653 €	F3R-239179AS	7,22	1790	2065	3.841 €
	F3R-239179BC	8	1790	2360	4.878 €	F3R-239179BS	7,94	1790	2265	4.069 €
	F3R-239179CC	8,72	1790	2560	5.102 €	F3R-239179CS	8,67	1790	2465	4.295 €
<b>F4</b>	F4R-239199AC	8,16	1990	2160	4.924 €	F4R-239199AS	8,1	1990	2065	4.019 €
	F4R-239199BC	8,98	1990	2360	5.158 €	F4R-239199BS	8,92	1990	2265	4.254 €
	F4R-239199CC	9,79	1990	2560	5.399 €	F4R-239199CS	9,73	1990	2465	4.486 €
<b>F5</b>	F5R-239219AC	9,05	2190	2160	5.204 €	F5R-239219AS	8,99	2190	2065	4.201 €
	F5R-239219BC	9,96	2190	2360	5.452 €	F5R-239219BS	9,89	2190	2265	4.443 €
	F5R-239219CC	10,86	2190	2560	5.688 €	F5R-239219CS	10,8	2190	2465	4.688 €
<b>F6</b>	F6R-239239AC	9,95	2390	2160	5.478 €	F6R-239239AS	10	2390	2065	4.385 €
	F6R-239239BC	10,94	2390	2360	5.736 €	F6R-239239BS	11	2390	2265	4.639 €
	F6R-239239CC	11,93	2390	2560	5.989 €	F6R-239239CS	12	2390	2465	4.891 €
<b>F7</b>	F7R-239259AC	10,84	2590	2160	5.758 €	F7R-239259AS	11	2590	2065	4.559 €
	F7R-239259BC	11,92	2590	2360	6.028 €	F7R-239259BS	12	2590	2265	4.824 €
	F7R-239259CC	13,01	2590	2560	6.290 €	F7R-239259CS	13	2590	2465	5.092 €
<b>F8</b>	F8R-239279AC	11,73	2790	2160	6.028 €	F8R-239279AS	12	2790	2065	4.735 €
	F8R-239279BC	12,9	2790	2360	6.313 €	F8R-239279BS	13	2790	2265	5.010 €
	F8R-239279CC	14,08	2790	2560	6.581 €	F8R-239279CS	14	2790	2465	5.294 €
<b>F9</b>	F9R-239299AC	12,62	2990	2160	6.306 €	F9R-239299AS	13	2990	2065	4.923 €
	F9R-239299BC	13,88	2990	2360	6.591 €	F9R-239299BS	14	2990	2265	5.200 €
	F9R-239299CC	15,15	2990	2560	6.878 €	F9R-239299CS	15	2990	2465	5.490 €
<b>F10</b>	F10R-239319AC	13,51	3190	2160	6.592 €	F10R-239319AS	13	3190	2065	5.093 €
	F10R-239319BC	14,87	3190	2360	6.882 €	F10R-239319BS	15	3190	2265	5.389 €
	F10R-239319CC	16,22	3190	2560	7.184 €	F10R-239319CS	16	3190	2465	5.690 €
<b>F11</b>	F11R-239339AC	14,41	3390	2160	6.865 €	F11R-239339AS	14	3390	2065	5.279 €
	F11R-239339BC	15,85	3390	2360	7.169 €	F11R-239339BS	16	3390	2265	5.580 €
	F11R-239339CC	17,29	3390	2560	7.536 €	F11R-239339CS	17	3390	2465	5.891 €
<b>F12</b>	F12R-239359AC	15,3	3590	2160	7.135 €	F12R-239359AS	15	3590	2065	5.452 €
	F12R-239359BC	16,83	3590	2360	7.512 €	F12R-239359BS	17	3590	2265	5.775 €
	F12R-239359CC	18,36	3590	2560	7.834 €	F12R-239359CS	18	3590	2465	6.085 €
<b>F13</b>	F13R-239379AC	16,19	3790	2160	7.476 €	F13R-239379AS	16	3790	2065	5.638 €
	F13R-239379BC	17,81	3790	2360	7.798 €	F13R-239379BS	18	3790	2265	5.966 €
	F13R-239379CC	19,43	3790	2560	8.112 €	F13R-239379CS	19	3790	2465	6.290 €
<b>F14</b>	F14R-239399AC	17,08	3990	2160	7.758 €	F14R-239399AS	17	3990	2065	5.812 €
	F14R-239399BC	18,79	3990	2360	8.078 €	F14R-239399BS	19	3990	2265	6.149 €
	F14R-239399CC	20,5	3990	2560	8.402 €	F14R-239399CS	20	3990	2465	6.492 €
<b>F15</b>	F15R-239419AC	17,97	4190	2160	8.015 €	F15R-239419AS	18	4190	2065	5.996 €
	F15R-239419BC	19,77	4190	2360	8.361 €	F15R-239419BS	20	4190	2265	6.337 €
	F15R-239419CC	21,57	4190	2560	8.691 €	F15R-239419CS	21	4190	2465	6.680 €
<b>F16</b>	F16R-239439AC	18,87	4390	2160	8.284 €	F16R-239439AS	19	4390	2065	6.172 €
	F16R-239439BC	20,75	4390	2360	8.648 €	F16R-239439BS	21	4390	2265	6.527 €
	F16R-239439CC	22,64	4390	2560	8.987 €	F16R-239439CS	23	4390	2465	6.881 €
<b>F17</b>	F17R-239459AC	19,76	4590	2160	8.554 €	F17R-239459AS	20	4590	2065	6.357 €
	F17R-239459BC	21,73	4590	2360	8.918 €	F17R-239459BS	22	4590	2265	6.722 €
	F17R-239459CC	23,71	4590	2560	9.280 €	F17R-239459CS	24	4590	2465	7.088 €
<b>F18</b>	F18R-239479AC	20,65	4790	2160	8.837 €	F18R-239479AS	20	4790	2065	6.531 €
	F18R-239479BC	22,71	4790	2360	9.207 €	F18R-239479BS	23	4790	2265	6.910 €
	F18R-239479CC	24,78	4790	2560	9.567 €	F18R-239479CS	25	4790	2465	7.287 €
<b>F19</b>	F19R-239499AC	21,54	4990	2160	9.091 €	F19R-239499AS	21	4990	2065	6.706 €
	F19R-239499BC	23,7	4990	2360	9.485 €	F19R-239499BS	24	4990	2265	7.099 €
	F19R-239499CC	25,85	4990	2560	9.862 €	F19R-239499CS	26	4990	2465	7.489 €

<b>100</b>	Largo - Length (L)																			
	1430	1630	1830	2030	2230	2430	2630	2830	3030	3230	3430	3630	3830	4030	4230	4430	4630	4830	5030	
Fondo - Depth mm	2430	F1	F2	F3	F4	F5	F6	F7	F8	F9	F10	F11	F12	F13	F14	F15	F16	F17	F18	F19

<b>100</b>	CON suelo - WITH floor panel					SIN suelo - WITHOUT floor panel				
	COD	m³	L	H	€	COD	m³	L	H	€
<b>F1</b>	F1C-243143AC	5,49	1430	2200	4.449 €	F1C-243143AS	5,44	1430	2085	3.823 €
	F1C-243143BC	6,03	1430	2400	4.672 €	F1C-243143BS	5,99	1430	2285	4.047 €
	F1C-243143CC	6,58	1430	2600	4.894 €	F1C-243143CS	6,54	1430	2485	4.268 €
<b>F2</b>	F2C-243163AC	6,38	1630	2200	4.737 €	F2C-243163AS	6,33	1630	2085	4.015 €
	F2C-243163BC	7,02	1630	2400	4.968 €	F2C-243163BS	6,97	1630	2285	4.254 €
	F2C-243163CC	7,65	1630	2600	5.207 €	F2C-243163CS	7,61	1630	2485	4.485 €
<b>F3</b>	F3C-243183AC	7,27	1830	2200	5.031 €	F3C-243183AS	7,22	1830	2085	4.213 €
	F3C-243183BC	8	1830	2400	5.276 €	F3C-243183BS	7,94	1830	2285	4.457 €
	F3C-243183CC	8,72	1830	2600	5.515 €	F3C-243183CS	8,67	1830	2485	4.697 €
<b>F4</b>	F4C-243203AC	8,16	2030	2200	5.327 €	F4C-243203AS	8,1	2030	2085	4.402 €
	F4C-243203BC	8,98	2030	2400	5.578 €	F4C-243203BS	8,92	2030	2285	4.662 €
	F4C-243203CC	9,79	2030	2600	5.833 €	F4C-243203CS	9,73	2030	2485	4.911 €
<b>F5</b>	F5C-243223AC	9,05	2230	2200	5.618 €	F5C-243223AS	8,99	2230	2085	4.603 €
	F5C-243223BC	9,96	2230	2400	5.881 €	F5C-243223BS	9,89	2230	2285	4.862 €
	F5C-243223CC	10,86	2230	2600	6.144 €	F5C-243223CS	10,8	2230	2485	5.133 €
<b>F6</b>	F6C-243243AC	9,95	2430	2200	5.905 €	F6C-243243AS	10	2430	2085	4.792 €
	F6C-243243BC	10,94	2430	2400	6.186 €	F6C-243243BS	11	2430	2285	5.069 €
	F6C-243243CC	11,93	2430	2600	6.452 €	F6C-243243CS	12	2430	2485	5.348 €
<b>F7</b>	F7C-243263AC	10,84	2630	2200	6.190 €	F7C-243263AS	11	2630	2085	4.983 €
	F7C-243263BC	11,92	2630	2400	6.483 €	F7C-243263BS	12	2630	2285	5.278 €
	F7C-243263CC	13,01	2630	2600	6.763 €	F7C-243263CS	13	2630	2485	5.564 €
<b>F8</b>	F8C-243283AC	11,73	2830	2200	6.485 €	F8C-243283AS	12	2830	2085	5.178 €
	F8C-243283BC	12,9	2830	2400	6.785 €	F8C-243283BS	13	2830	2285	5.475 €
	F8C-243283CC	14,08	2830	2600	7.281 €	F8C-243283CS	14	2830	2485	5.770 €
<b>F9</b>	F9C-243303AC	12,62	3030	2200	6.772 €	F9C-243303AS	13	3030	2085	5.372 €
	F9C-243303BC	13,88	3030	2400	7.297 €	F9C-243303BS	14	3030	2285	5.680 €
	F9C-243303CC	15,15	3030	2600	7.597 €	F9C-243303CS	15	3030	2485	5.994 €
<b>F10</b>	F10C-243323AC	13,51	3230	2200	7.269 €	F10C-243323AS	13	3230	2085	5.561 €
	F10C-243323BC	14,87	3230	2400	7.590 €	F10C-243323BS	15	3230	2285	5.891 €
	F10C-243323CC	16,22	3230	2600	7.917 €	F10C-243323CS	16	3230	2485	6.201 €
<b>F11</b>	F11C-243343AC	14,41	3430	2200	7.557 €	F11C-243343AS	14	3430	2085	5.758 €
	F11C-243343BC	15,85	3430	2400	7.894 €	F11C-243343BS	16	3430	2285	6.090 €
	F11C-243343CC	17,29	3430	2600	8.079 €	F11C-243343CS	17	3430	2485	6.422 €
<b>F12</b>	F12C-243363AC	15,3	3630	2200	7.848 €	F12C-243363AS	15	3630	2085	5.952 €
	F12C-243363BC	16,83	3630	2400	8.055 €	F12C-243363BS	17	3630	2285	6.291 €
	F12C-243363CC	18,36	3630	2600	8.393 €	F12C-243363CS	18	3630	2485	6.836 €
<b>F13</b>	F13C-243383AC	16,19	3830	2200	8.007 €	F13C-243383AS	16	3830	2085	6.143 €
	F13C-243383BC	17,81	3830	2400	8.345 €	F13C-243383BS	18	3830	2285	6.505 €
	F13C-243383CC	19,								



80	Largo - Length (L)																		
	1390	1590	1790	1990	2190	2390	2590	2790	2990	3190	3390	3590	3790	3990	4190	4390	4590	4790	4990
Fondo - Depth mm 2590	G1	G2	G3	G4	G5	G6	G7	G8	G9	G10	G11	G12	G13	G14	G15	G16	G17	G18	G19

80	CON suelo - WITH floor panel					SIN suelo - WITHOUT floor panel				
	COD	m³	L	H	€	COD	m³	L	H	€
G1	G1R-259139AC	5,98	1390	2160	<b>4.310 €</b>	G1R-259139AS	5,93	1390	2065	<b>3.637 €</b>
	G1R-259139BC	6,58	1390	2360	<b>4.519 €</b>	G1R-259139BS	6,53	1390	2265	<b>3.849 €</b>
	G1R-259139CC	7,17	1390	2560	<b>4.733 €</b>	G1R-259139CS	7,13	1390	2465	<b>4.067 €</b>
G2	G2R-259159AC	6,95	1590	2160	<b>4.593 €</b>	G2R-259159AS	6,9	1590	2065	<b>3.821 €</b>
	G2R-259159BC	7,64	1590	2360	<b>4.815 €</b>	G2R-259159BS	7,59	1590	2265	<b>4.049 €</b>
	G2R-259159CC	8,34	1590	2560	<b>5.039 €</b>	G2R-259159CS	8,29	1590	2465	<b>4.272 €</b>
G3	G3R-259179AC	7,92	1790	2160	<b>4.892 €</b>	G3R-259179AS	7,86	1790	2065	<b>4.007 €</b>
	G3R-259179BC	8,71	1790	2360	<b>5.125 €</b>	G3R-259179BS	8,65	1790	2265	<b>4.241 €</b>
	G3R-259179CC	9,51	1790	2560	<b>5.354 €</b>	G3R-259179CS	9,45	1790	2465	<b>4.474 €</b>
G4	G4R-259199AC	8,89	1990	2160	<b>5.182 €</b>	G4R-259199AS	8,83	1990	2065	<b>4.188 €</b>
	G4R-259199BC	9,78	1990	2360	<b>5.418 €</b>	G4R-259199BS	9,72	1990	2265	<b>4.439 €</b>
	G4R-259199CC	10,67	1990	2560	<b>5.668 €</b>	G4R-259199CS	10,61	1990	2465	<b>4.676 €</b>
G5	G5R-259219AC	9,87	2190	2160	<b>5.467 €</b>	G5R-259219AS	9,79	2190	2065	<b>4.376 €</b>
	G5R-259219BC	10,85	2190	2360	<b>5.721 €</b>	G5R-259219BS	10,78	2190	2265	<b>4.634 €</b>
	G5R-259219CC	11,84	2190	2560	<b>5.980 €</b>	G5R-259219CS	11,76	2190	2465	<b>4.884 €</b>
G6	G6R-259239AC	10,84	2390	2160	<b>5.760 €</b>	G6R-259239AS	10,76	2390	2065	<b>4.555 €</b>
	G6R-259239BC	11,92	2390	2360	<b>6.020 €</b>	G6R-259239BS	11,84	2390	2265	<b>4.827 €</b>
	G6R-259239CC	13,01	2390	2560	<b>6.285 €</b>	G6R-259239CS	12,92	2390	2465	<b>5.092 €</b>
G7	G7R-259259AC	11,81	2590	2160	<b>6.050 €</b>	G7R-259259AS	12	2590	2065	<b>4.744 €</b>
	G7R-259259BC	12,99	2590	2360	<b>6.323 €</b>	G7R-259259BS	13	2590	2265	<b>5.022 €</b>
	G7R-259259CC	14,17	2590	2560	<b>6.603 €</b>	G7R-259259CS	14	2590	2465	<b>5.293 €</b>
G8	G8R-259279AC	12,78	2790	2160	<b>6.343 €</b>	G8R-259279AS	13	2790	2065	<b>4.933 €</b>
	G8R-259279BC	14,06	2790	2360	<b>6.617 €</b>	G8R-259279BS	14	2790	2265	<b>5.208 €</b>
	G8R-259279CC	15,34	2790	2560	<b>6.903 €</b>	G8R-259279CS	15	2790	2465	<b>5.503 €</b>
G9	G9R-259299AC	13,75	2990	2160	<b>6.628 €</b>	G9R-259299AS	14	2990	2065	<b>5.111 €</b>
	G9R-259299BC	15,13	2990	2360	<b>6.928 €</b>	G9R-259299BS	15	2990	2265	<b>5.413 €</b>
	G9R-259299CC	16,5	2990	2560	<b>7.225 €</b>	G9R-259299CS	16	2990	2465	<b>5.702 €</b>
G10	G10R-259319AC	14,73	3190	2160	<b>6.923 €</b>	G10R-259319AS	15	3190	2065	<b>5.299 €</b>
	G10R-259319BC	16,2	3190	2360	<b>7.218 €</b>	G10R-259319BS	16	3190	2265	<b>5.602 €</b>
	G10R-259319CC	17,67	3190	2560	<b>7.585 €</b>	G10R-259319CS	18	3190	2465	<b>5.905 €</b>
G11	G11R-259339AC	15,7	3390	2160	<b>7.207 €</b>	G11R-259339AS	16	3390	2065	<b>5.480 €</b>
	G11R-259339BC	17,27	3390	2360	<b>7.581 €</b>	G11R-259339BS	17	3390	2265	<b>5.793 €</b>
	G11R-259339CC	18,84	3390	2560	<b>7.888 €</b>	G11R-259339CS	19	3390	2465	<b>6.111 €</b>
G12	G12R-259359AC	16,67	3590	2160	<b>7.558 €</b>	G12R-259359AS	17	3590	2065	<b>5.671 €</b>
	G12R-259359BC	18,34	3590	2360	<b>7.884 €</b>	G12R-259359BS	18	3590	2265	<b>5.988 €</b>
	G12R-259359CC	20	3590	2560	<b>8.207 €</b>	G12R-259359CS	20	3590	2465	<b>6.314 €</b>
G13	G13R-259379AC	17,64	3790	2160	<b>7.849 €</b>	G13R-259379AS	18	3790	2065	<b>5.853 €</b>
	G13R-259379BC	19,41	3790	2360	<b>8.181 €</b>	G13R-259379BS	19	3790	2265	<b>6.190 €</b>
	G13R-259379CC	21,17	3790	2560	<b>8.507 €</b>	G13R-259379CS	21	3790	2465	<b>6.521 €</b>
G14	G14R-259399AC	18,61	3990	2160	<b>8.130 €</b>	G14R-259399AS	18	3990	2065	<b>6.035 €</b>
	G14R-259399BC	20,48	3990	2360	<b>8.468 €</b>	G14R-259399BS	20	3990	2265	<b>6.374 €</b>
	G14R-259399CC	22,34	3990	2560	<b>8.800 €</b>	G14R-259399CS	22	3990	2465	<b>6.721 €</b>
G15	G15R-259419AC	19,59	4190	2160	<b>8.418 €</b>	G15R-259419AS	19	4190	2065	<b>6.222 €</b>
	G15R-259419BC	21,54	4190	2360	<b>8.767 €</b>	G15R-259419BS	21	4190	2265	<b>6.578 €</b>
	G15R-259419CC	23,5	4190	2560	<b>9.105 €</b>	G15R-259419CS	23	4190	2465	<b>6.926 €</b>
G16	G16R-259439AC	20,56	4390	2160	<b>8.698 €</b>	G16R-259439AS	20	4390	2065	<b>6.405 €</b>
	G16R-259439BC	22,61	4390	2360	<b>9.057 €</b>	G16R-259439BS	22	4390	2265	<b>6.772 €</b>
	G16R-259439CC	24,67	4390	2560	<b>9.419 €</b>	G16R-259439CS	25	4390	2465	<b>7.214 €</b>
G17	G17R-259459AC	21,53	4590	2160	<b>8.985 €</b>	G17R-259459AS	21	4590	2065	<b>6.581 €</b>
	G17R-259459BC	23,68	4590	2360	<b>9.358 €</b>	G17R-259459BS	24	4590	2265	<b>6.958 €</b>
	G17R-259459CC	25,84	4590	2560	<b>9.723 €</b>	G17R-259459CS	26	4590	2465	<b>7.423 €</b>
G18	G18R-259479AC	22,5	4790	2160	<b>9.258 €</b>	G18R-259479AS	22	4790	2065	<b>6.766 €</b>
	G18R-259479BC	24,75	4790	2360	<b>9.638 €</b>	G18R-259479BS	25	4790	2265	<b>7.161 €</b>
	G18R-259479CC	27	4790	2560	<b>10.011 €</b>	G18R-259479CS	27	4790	2465	<b>7.627 €</b>
G19	G19R-259499AC	23,47	4990	2160	<b>9.559 €</b>	G19R-259499AS	23	4990	2065	<b>6.953 €</b>
	G19R-259499BC	25,82	4990	2360	<b>9.931 €</b>	G19R-259499BS	26	4990	2265	<b>7.358 €</b>
	G19R-259499CC	28,17	4990	2560	<b>10.328 €</b>	G19R-259499CS	28	4990	2465	<b>7.831 €</b>

100	Largo - Length (L)																			
	1430	1630	1830	2030	2230	2430	2630	2830	3030	3230	3430	3630	3830	4030	4230	4430	4630	4830	5030	
Fondo - Depth mm 2630	G1	G2	G3	G4	G5	G6	G7	G8	G9	G10	G11	G12	G13	G14	G15	G16	G17	G18	G19	

100	CON suelo - WITH floor panel					SIN suelo - WITHOUT floor panel				
	COD	m³	L	H	€	COD	m³	L	H	€
G1	G1C-263143AC	5,98	1430	2200	<b>4.672 €</b>	G1C-263143AS	5,93	1430	2085	<b>3.989 €</b>
	G1C-263143BC	6,58	1430	2400	<b>4.904 €</b>	G1C-263143BS	6,53	1430	2285	<b>4.223 €</b>
	G1C-263143CC	7,17	1430	2600	<b>5.132 €</b>	G1C-263143CS	7,13	1430	2485	<b>4.459 €</b>
G2	G2C-263163AC	6,95	1630	2200	<b>4.970 €</b>	G2C-263163AS	6,9	1630	2085	<b>4.187 €</b>
	G2C-263163BC	7,64	1630	2400	<b>5.222 €</b>	G2C-263163BS	7,59	1630	2285	<b>4.434 €</b>
	G2C-263163CC	8,34	1630	2600	<b>5.463 €</b>	G2C-263163CS	8,29	1630	2485	<b>4.677 €</b>
G3	G3C-263183AC	7,92	1830	2200	<b>5.282 €</b>	G3C-263183AS	7,86	1830	2085	<b>4.387 €</b>
	G3C-263183BC	8,71	1830	2400	<b>5.539 €</b>	G3C-263183BS	8,65	1830	2285	<b>4.646 €</b>
	G3C-263183CC	9,51	1830	2600	<b>5.791 €</b>	G3C-263183CS	9,45	1830	2485	<b>4.901 €</b>
G4	G4C-263203AC	8,89	2030	2200	<b>5.586 €</b>	G4C-263203AS	8,83	2030	2085	<b>4.588 €</b>
	G4C-263203BC	9,78	2030	2400	<b>5.852 €</b>	G4C-263203BS	9,72	2030	2285	<b>4.848 €</b>
	G4C-263203CC	10,67	2030	2600	<b>6.111 €</b>	G4C-263203CS	10,61	2030	2485	<b>5.114 €</b>
G5	G5C-263223AC	9,87	2230	2200	<b>5.886 €</b>	G5C-263223AS	9,79	2230	2085	<b>4.784 €</b>
	G5C-263223BC	10,85	2230	2400	<b>6.167 €</b>	G5C-263223BS	10,78	2230	2285	<b>5.063 €</b>
	G5C-263223CC	11,84	2230	2600	<b>6.447 €</b>	G5C-263223CS	11,76	2230	2485	<b>5.342 €</b>
G6	G6C-263243AC	10,84	2430	2200	<b>6.190 €</b>	G6C-263243AS	10,76	2430	2085	<b>4.983 €</b>
	G6C-263243BC	11,92	2430	2400	<b>6.488 €</b>	G6C-263243BS	11,84	2430	2285	<b>5.272 €</b>
	G6C-263243CC	13,01	2430	2600	<b>6.775 €</b>	G6C-263243CS	12,92	2430	2485	<b>5.556 €</b>
G7	G7C-263263AC	11,81	2630	2200	<b>6.498 €</b>	G7C-263263AS	12	2630	2085	<b>5.178 €</b>
	G7C-263263BC	12,99	2630	2400	<b>6.801 €</b>	G7C-263263BS	13	2630	2285	<b>5.479 €</b>
	G7C-263263CC	14,17	2630	2600	<b>7.296 €</b>	G7C-263263CS	14	2630	2485	<b>5.776 €</b>
G8	G8C-263283AC	12,78	2830	2200	<b>6.805 €</b>	G8C-263283AS	13	2830	2085	<b>5.383 €</b>
	G8C-263283BC	14,06	2830	2400	<b>7.323 €</b>	G8C-263283BS	14	2830	2285	<b>5.695 €</b>
	G8C-263283CC	15,34	2830	2600	<b>7.628 €</b>	G8C-263283CS	15	2830	2485	<b>6.003 €</b>
G9	G9C-263303AC	13,75	3030	2200	<b>7.316 €</b>	G9C-263303AS	14	3030	2085	<b>5.585 €</b>
	G9C-263303BC	15,13	3030	2400	<b>7.641 €</b>	G9C-263303BS	15	3030	2285	<b>5.900 €</b>
	G9C-263303CC	16,5	3030	2600	<b>7.964 €</b>	G9C-263303CS	16	3030	2485	<b>6.220 €</b>
G10	G10C-263323AC	14,73	3230	2200	<b>7.618 €</b>	G10C-263323AS	15	3230	2085	<b>5.778 €</b>
	G10C-263323BC	16,2	3230	2400	<b>7.957 €</b>	G10C-263323BS	16	3230	2285	<b>6.116 €</b>
	G10C-263323CC	17,67	3230	2600	<b>8.127 €</b>	G10C-263323CS	18	3230	2485	<b>6.445 €</b>
G11	G11C-263343AC	15,7	3430	2200	<b>7.923 €</b>	G11C-263343AS	16	3430	2085	<b>5.981 €</b>
	G11C-263343BC	17,27	3430	2400	<b>8.121 €</b>	G11C-263343BS	17	3430	2285	<b>6.325 €</b>
	G11C-263343CC	18,84	34							



80	Largo - Length (L)																		
	1390	1590	1790	1990	2190	2390	2590	2790	2990	3190	3390	3590	3790	3990	4190	4390	4590	4790	4990
Fondo - Depth mm 2790	H1	H2	H3	H4	H5	H6	H7	H8	H9	H10	H11	H12	H13	H14	H15	H16	H17	H18	H19

80	CON suelo - WITH floor panel						SIN suelo - WITHOUT floor panel					
	COD	m³	L	H	€	COD	m³	L	H	€		
H1	H1R-279139AC	6,47	1390	2160	4.516 €	H1R-279139AS	6,42	1390	2065	3.788 €		
	H1R-279139BC	7,12	1390	2360	4.734 €	H1R-279139BS	7,07	1390	2265	4.019 €		
	H1R-279139CC	7,76	1390	2560	4.960 €	H1R-279139CS	7,72	1390	2465	4.242 €		
H2	H2R-279159AC	7,52	1590	2160	4.820 €	H2R-279159AS	7,47	1590	2065	3.985 €		
	H2R-279159BC	8,27	1590	2360	5.055 €	H2R-279159BS	8,22	1590	2265	4.214 €		
	H2R-279159CC	9,03	1590	2560	5.286 €	H2R-279159CS	8,97	1590	2465	4.448 €		
H3	H3R-279179AC	8,57	1790	2160	5.117 €	H3R-279179AS	8,51	1790	2065	4.170 €		
	H3R-279179BC	9,43	1790	2360	5.368 €	H3R-279179BS	9,37	1790	2265	4.412 €		
	H3R-279179CC	10,29	1790	2560	5.615 €	H3R-279179CS	10,22	1790	2465	4.663 €		
H4	H4R-279199AC	9,63	1990	2160	5.426 €	H4R-279199AS	9,55	1990	2065	4.364 €		
	H4R-279199BC	10,59	1990	2360	5.684 €	H4R-279199BS	10,52	1990	2265	4.612 €		
	H4R-279199CC	11,55	1990	2560	5.929 €	H4R-279199CS	11,48	1990	2465	4.868 €		
H5	H5R-279219AC	10,68	2190	2160	5.735 €	H5R-279219AS	10,6	2190	2065	4.546 €		
	H5R-279219BC	11,75	2190	2360	5.993 €	H5R-279219BS	11,67	2190	2265	4.819 €		
	H5R-279219CC	12,81	2190	2560	6.264 €	H5R-279219CS	12,73	2190	2465	5.078 €		
H6	H6R-279239AC	11,73	2390	2160	6.027 €	H6R-279239AS	11,64	2390	2065	4.735 €		
	H6R-279239BC	12,9	2390	2360	6.306 €	H6R-279239BS	12,81	2390	2265	5.012 €		
	H6R-279239CC	14,08	2390	2560	6.580 €	H6R-279239CS	13,99	2390	2465	5.294 €		
H7	H7R-279259AC	12,78	2590	2160	6.332 €	H7R-279259AS	12,69	2590	2065	4.924 €		
	H7R-279259BC	14,06	2590	2360	6.620 €	H7R-279259BS	13,96	2590	2265	5.208 €		
	H7R-279259CC	15,34	2590	2560	6.903 €	H7R-279259CS	15,24	2590	2465	5.502 €		
H8	H8R-279279AC	13,83	2790	2160	6.646 €	H8R-279279AS	14	2790	2065	5.118 €		
	H8R-279279BC	15,22	2790	2360	6.944 €	H8R-279279BS	15	2790	2265	5.417 €		
	H8R-279279CC	16,6	2790	2560	7.239 €	H8R-279279CS	17	2790	2465	5.714 €		
H9	H9R-279299AC	14,89	2990	2160	6.942 €	H9R-279299AS	15	2990	2065	5.311 €		
	H9R-279299BC	16,37	2990	2360	7.254 €	H9R-279299BS	16	2990	2265	5.610 €		
	H9R-279299CC	17,86	2990	2560	7.620 €	H9R-279299CS	18	2990	2465	5.914 €		
H10	H10R-279319AC	15,94	3190	2160	7.249 €	H10R-279319AS	16	3190	2065	5.495 €		
	H10R-279319BC	17,53	3190	2360	7.624 €	H10R-279319BS	18	3190	2265	5.809 €		
	H10R-279319CC	19,13	3190	2560	7.933 €	H10R-279319CS	19	3190	2465	6.127 €		
H11	H11R-279339AC	16,99	3390	2160	7.619 €	H11R-279339AS	17	3390	2065	5.684 €		
	H11R-279339BC	18,69	3390	2360	7.941 €	H11R-279339BS	19	3390	2265	6.016 €		
	H11R-279339CC	20,39	3390	2560	8.260 €	H11R-279339CS	20	3390	2465	6.339 €		
H12	H12R-279359AC	18,04	3590	2160	7.911 €	H12R-279359AS	18	3590	2065	5.874 €		
	H12R-279359BC	19,85	3590	2360	8.246 €	H12R-279359BS	20	3590	2265	6.209 €		
	H12R-279359CC	21,65	3590	2560	8.577 €	H12R-279359CS	22	3590	2465	6.554 €		
H13	H13R-279379AC	19,09	3790	2160	8.202 €	H13R-279379AS	19	3790	2065	6.061 €		
	H13R-279379BC	21	3790	2360	8.558 €	H13R-279379BS	21	3790	2265	6.406 €		
	H13R-279379CC	22,91	3790	2560	8.885 €	H13R-279379CS	23	3790	2465	6.765 €		
H14	H14R-279399AC	20,15	3990	2160	8.516 €	H14R-279399AS	20	3990	2065	6.250 €		
	H14R-279399BC	22,16	3990	2360	8.853 €	H14R-279399BS	22	3990	2265	6.607 €		
	H14R-279399CC	24,17	3990	2560	9.196 €	H14R-279399CS	24	3990	2465	7.054 €		
H15	H15R-279419AC	21,2	4190	2160	8.803 €	H15R-279419AS	21	4190	2065	6.438 €		
	H15R-279419BC	23,32	4190	2360	9.160 €	H15R-279419BS	23	4190	2265	6.808 €		
	H15R-279419CC	25,44	4190	2560	9.527 €	H15R-279419CS	25	4190	2465	7.257 €		
H16	H16R-279439AC	22,25	4390	2160	9.100 €	H16R-279439AS	22	4390	2065	6.629 €		
	H16R-279439BC	24,47	4390	2360	9.463 €	H16R-279439BS	24	4390	2265	7.098 €		
	H16R-279439CC	26,7	4390	2560	9.848 €	H16R-279439CS	27	4390	2465	7.459 €		
H17	H17R-279459AC	23,3	4590	2160	9.390 €	H17R-279459AS	23	4590	2065	6.826 €		
	H17R-279459BC	25,63	4590	2360	9.779 €	H17R-279459BS	26	4590	2265	7.291 €		
	H17R-279459CC	27,96	4590	2560	10.162 €	H17R-279459CS	28	4590	2465	7.674 €		
H18	H18R-279479AC	24,35	4790	2160	9.700 €	H18R-279479AS	24	4790	2065	7.016 €		
	H18R-279479BC	26,79	4790	2360	10.090 €	H18R-279479BS	27	4790	2265	7.487 €		
	H18R-279479CC	29,22	4790	2560	10.483 €	H18R-279479CS	29	4790	2465	7.873 €		
H19	H19R-279499AC	25,41	4990	2160	9.984 €	H19R-279499AS	25	4990	2065	7.202 €		
	H19R-279499BC	27,95	4990	2360	10.399 €	H19R-279499BS	28	4990	2265	7.679 €		
	H19R-279499CC	30,49	4990	2560	10.802 €	H19R-279499CS	30	4990	2465	8.081 €		

100	Largo - Length (L)																		
	1430	1630	1830	2030	2230	2430	2630	2830	3030	3230	3430	3630	3830	4030	4230	4430	4630	4830	5030
Fondo - Depth mm 2830	H1	H2	H3	H4	H5	H6	H7	H8	H9	H10	H11	H12	H13	H14	H15	H16	H17	H18	H19

100	CON suelo - WITH floor panel						SIN suelo - WITHOUT floor panel					
	COD	m³	L	H	€	COD	m³	L	H	€		
H1	H1C-283143AC	6,47	1430	2200	4.884 €	H1C-283143AS	6,42	1430	2085	4.160 €		
	H1C-283143BC	7,12	1430	2400	5.137 €	H1C-283143BS	7,07	1430	2285	4.400 €		
	H1C-283143CC	7,76	1430	2600	5.373 €	H1C-283143CS	7,72	1430	2485	4.642 €		
H2	H2C-283163AC	7,52	1630	2200	5.211 €	H2C-283163AS	7,47	1630	2085	4.365 €		
	H2C-283163BC	8,27	1630	2400	5.467 €	H2C-283163BS	8,22	1630	2285	4.620 €		
	H2C-283163CC	9,03	1630	2600	5.717 €	H2C-283163CS	8,97	1630	2485	4.869 €		
H3	H3C-283183AC	8,57	1830	2200	5.524 €	H3C-283183AS	8,51	1830	2085	4.563 €		
	H3C-283183BC	9,43	1830	2400	5.794 €	H3C-283183BS	9,37	1830	2285	4.835 €		
	H3C-283183CC	10,29	1830	2600	6.060 €	H3C-283183CS	10,22	1830	2485	5.095 €		
H4	H4C-283203AC	9,63	2030	2200	5.845 €	H4C-283203AS	9,55	2030	2085	4.770 €		
	H4C-283203BC	10,59	2030	2400	6.129 €	H4C-283203BS	10,52	2030	2285	5.044 €		
	H4C-283203CC	11,55	2030	2600	6.402 €	H4C-283203CS	11,48	2030	2485	5.319 €		
H5	H5C-283223AC	10,68	2230	2200	6.169 €	H5C-283223AS	10,6	2230	2085	4.976 €		
	H5C-283223BC	11,75	2230	2400	6.453 €	H5C-283223BS	11,67	2230	2285	5.265 €		
	H5C-283223CC	12,81	2230	2600	6.744 €	H5C-283223CS	12,73	2230	2485	5.552 €		
H6	H6C-283243AC	11,73	2430	2200	6.480 €	H6C-283243AS	11,64	2430	2085	5.178 €		
	H6C-283243BC	12,9	2430	2400	6.789 €	H6C-283243BS	12,81	2430	2285	5.480 €		
	H6C-283243CC	14,08	2430	2600	7.281 €	H6C-283243CS	13,99	2430	2485	5.776 €		
H7	H7C-283263AC	12,78	2630	2200	6.801 €	H7C-283263AS	12,69	2630	2085	5.381 €		
	H7C-283263BC	14,06	2630	2400	7.326 €	H7C-283263BS	13,96	2630	2285	5.692 €		
	H7C-283263CC	15,34	2630	2600	7.631 €	H7C-283263CS	15,24	2630	2485	6.004 €		
H8	H8C-283283AC	13,83	2830	2200	7.328 €	H8C-283283AS	14	2830	2085	5.586 €		
	H8C-283283BC	15,22	2830	2400	7.652 €	H8C-283283BS	15	2830	2285	5.910 €		
	H8C-283283CC	16,6	2830	2600	7.975 €	H8C-283283CS	17	2830	2485	6.223 €		
H9	H9C-283303AC	14,89	3030	2200	7.647 €	H9C-283303AS	15	3030	2085	5.797 €		
	H9C-283303BC	16,37	3030	2400	7.973 €	H9C-283303BS	16	3030	2285	6.120 €		
	H9C-283303CC	17,86	3030	2600	8.167 €	H9C-283303CS	18	3030	2485	6.462 €		
H10	H10C-283323AC	15,94	3230	2200	7.967 €	H10C-283323AS	16	3230	2085	5.991 €		
	H10C-283323BC	17,53	3230	2400	8.157 €	H10C-283323BS	17	3230	2285	6.333 €		
	H10C-283323CC	19,13	3230	2600	8.497 €	H10C-283323CS	19	3230	2485	6.889 €		
H11	H11C-283343AC	16,99	3430	2200	8.136 €	H11C-283343AS	17	3430	2085	6.199 €		
	H11C-283343BC	18,69	3430	2400	8.490 €	H11C-283343BS	19	3430	2285	6.548 €		
	H11C-283343CC	20,39	3430	2600	8.822 €	H11C-283343CS	20	3430	2485	7.110 €		
H12	H12C-283363AC	18,04	3630	2200	8.442 €	H12C-283363AS	18	3630	2085	6.412 €		
	H12C-283363BC	19,85	3630	2400	8.804 €	H12C-283363BS	20	3630	2285	6.968 €		
	H12C-283363CC	21,65	3630	2600	9.154 €	H12C-283363CS	22	3630	2485	7.336 €		
H13	H13C-283383AC	19,09	3830	2200	8.768 €	H13C-283383AS	19	3830	2085	6.605 €		
	H13C-283383BC	21	3830	2400	9.134 €	H13C-283383BS	21	3830	2285	7.188 €		
	H13C-283383CC	22,91	3830	2600	9.489 €	H13C-283383CS	23					



80	Largo - Length (L)																		
	1390	1590	1790	1990	2190	2390	2590	2790	2990	3190	3390	3590	3790	3990	4190	4390	4590	4790	4990
Fondo - Depth mm 2990	J1	J2	J3	J4	J5	J6	J7	J8	J9	J10	J11	J12	J13	J14	J15	J16	J17	J18	J19

80	CON suelo - WITH floor panel					SIN suelo - WITHOUT floor panel				
	COD	m³	L	H	€	COD	m³	L	H	€
J1	J1R-299139AC	6,96	1390	2160	<b>4.717 €</b>	J1R-299139AS	6,91	1390	2065	<b>3.943 €</b>
	J1R-299139BC	7,66	1390	2360	<b>4.952 €</b>	J1R-299139BS	7,61	1390	2265	<b>4.181 €</b>
	J1R-299139CC	8,35	1390	2560	<b>5.187 €</b>	J1R-299139CS	8,3	1390	2465	<b>4.414 €</b>
J2	J2R-299159AC	8,09	1590	2160	<b>5.038 €</b>	J2R-299159AS	8,03	1590	2065	<b>4.139 €</b>
	J2R-299159BC	8,9	1590	2360	<b>5.277 €</b>	J2R-299159BS	8,84	1590	2265	<b>4.381 €</b>
	J2R-299159CC	9,71	1590	2560	<b>5.525 €</b>	J2R-299159CS	9,65	1590	2465	<b>4.624 €</b>
J3	J3R-299179AC	9,23	1790	2160	<b>5.356 €</b>	J3R-299179AS	9,16	1790	2065	<b>4.335 €</b>
	J3R-299179BC	10,15	1790	2360	<b>5.613 €</b>	J3R-299179BS	10,08	1790	2265	<b>4.589 €</b>
	J3R-299179CC	11,07	1790	2560	<b>5.866 €</b>	J3R-299179CS	11	1790	2465	<b>4.839 €</b>
J4	J4R-299199AC	10,36	1990	2160	<b>5.674 €</b>	J4R-299199AS	10,28	1990	2065	<b>4.532 €</b>
	J4R-299199BC	11,39	1990	2360	<b>5.943 €</b>	J4R-299199BS	11,32	1990	2265	<b>4.798 €</b>
	J4R-299199CC	12,43	1990	2560	<b>6.202 €</b>	J4R-299199CS	12,35	1990	2465	<b>5.057 €</b>
J5	J5R-299219AC	11,49	2190	2160	<b>5.995 €</b>	J5R-299219AS	11,4	2190	2065	<b>4.719 €</b>
	J5R-299219BC	12,64	2190	2360	<b>6.269 €</b>	J5R-299219BS	12,55	2190	2265	<b>4.999 €</b>
	J5R-299219CC	13,79	2190	2560	<b>6.547 €</b>	J5R-299219CS	13,7	2190	2465	<b>5.272 €</b>
J6	J6R-299239AC	12,62	2390	2160	<b>6.307 €</b>	J6R-299239AS	12,53	2390	2065	<b>4.917 €</b>
	J6R-299239BC	13,88	2390	2360	<b>6.597 €</b>	J6R-299239BS	13,79	2390	2265	<b>5.203 €</b>
	J6R-299239CC	15,15	2390	2560	<b>6.879 €</b>	J6R-299239CS	15,05	2390	2465	<b>5.484 €</b>
J7	J7R-299259AC	13,75	2590	2160	<b>6.633 €</b>	J7R-299259AS	13,65	2590	2065	<b>5.110 €</b>
	J7R-299259BC	15,13	2590	2360	<b>6.922 €</b>	J7R-299259BS	15,03	2590	2265	<b>5.408 €</b>
	J7R-299259CC	16,5	2590	2560	<b>7.220 €</b>	J7R-299259CS	16,4	2590	2465	<b>5.698 €</b>
J8	J8R-299279AC	14,89	2790	2160	<b>6.940 €</b>	J8R-299279AS	14,77	2790	2065	<b>5.308 €</b>
	J8R-299279BC	16,37	2790	2360	<b>7.251 €</b>	J8R-299279BS	16,26	2790	2265	<b>5.612 €</b>
	J8R-299279CC	17,86	2790	2560	<b>7.624 €</b>	J8R-299279CS	17,75	2790	2465	<b>5.924 €</b>
J9	J9R-299299AC	16,02	2990	2160	<b>7.422 €</b>	J9R-299299AS	16	2990	2065	<b>5.665 €</b>
	J9R-299299BC	17,62	2990	2360	<b>7.791 €</b>	J9R-299299BS	18	2990	2265	<b>5.976 €</b>
	J9R-299299CC	19,22	2990	2560	<b>8.105 €</b>	J9R-299299CS	19	2990	2465	<b>6.299 €</b>
J10	J10R-299319AC	17,15	3190	2160	<b>7.816 €</b>	J10R-299319AS	17	3190	2065	<b>5.867 €</b>
	J10R-299319BC	18,86	3190	2360	<b>8.128 €</b>	J10R-299319BS	19	3190	2265	<b>6.196 €</b>
	J10R-299319CC	20,58	3190	2560	<b>8.442 €</b>	J10R-299319CS	20	3190	2465	<b>6.516 €</b>
J11	J11R-299339AC	18,28	3390	2160	<b>8.126 €</b>	J11R-299339AS	18	3390	2065	<b>6.074 €</b>
	J11R-299339BC	20,11	3390	2360	<b>8.463 €</b>	J11R-299339BS	20	3390	2265	<b>6.402 €</b>
	J11R-299339CC	21,94	3390	2560	<b>8.787 €</b>	J11R-299339CS	22	3390	2465	<b>6.740 €</b>
J12	J12R-299359AC	19,41	3590	2160	<b>8.463 €</b>	J12R-299359AS	19	3590	2065	<b>6.281 €</b>
	J12R-299359BC	21,36	3590	2360	<b>8.796 €</b>	J12R-299359BS	21	3590	2265	<b>6.619 €</b>
	J12R-299359CC	23,3	3590	2560	<b>9.134 €</b>	J12R-299359CS	23	3590	2465	<b>6.971 €</b>
J13	J13R-299379AC	20,55	3790	2160	<b>8.785 €</b>	J13R-299379AS	20	3790	2065	<b>6.478 €</b>
	J13R-299379BC	22,6	3790	2360	<b>9.118 €</b>	J13R-299379BS	22	3790	2265	<b>6.839 €</b>
	J13R-299379CC	24,65	3790	2560	<b>9.469 €</b>	J13R-299379CS	25	3790	2465	<b>7.278 €</b>
J14	J14R-299399AC	21,68	3990	2160	<b>9.098 €</b>	J14R-299399AS	22	3990	2065	<b>6.685 €</b>
	J14R-299399BC	23,85	3990	2360	<b>9.463 €</b>	J14R-299399BS	24	3990	2265	<b>7.049 €</b>
	J14R-299399CC	26,01	3990	2560	<b>9.817 €</b>	J14R-299399CS	26	3990	2465	<b>7.496 €</b>
J15	J15R-299419AC	22,81	4190	2160	<b>9.414 €</b>	J15R-299419AS	23	4190	2065	<b>6.892 €</b>
	J15R-299419BC	25,09	4190	2360	<b>9.782 €</b>	J15R-299419BS	25	4190	2265	<b>7.346 €</b>
	J15R-299419CC	27,37	4190	2560	<b>10.150 €</b>	J15R-299419CS	27	4190	2465	<b>7.724 €</b>
J16	J16R-299439AC	23,94	4390	2160	<b>9.746 €</b>	J16R-299439AS	24	4390	2065	<b>7.099 €</b>
	J16R-299439BC	26,34	4390	2360	<b>10.132 €</b>	J16R-299439BS	26	4390	2265	<b>7.561 €</b>
	J16R-299439CC	28,73	4390	2560	<b>10.493 €</b>	J16R-299439CS	29	4390	2465	<b>7.947 €</b>
J17	J17R-299459AC	25,07	4590	2160	<b>10.070 €</b>	J17R-299459AS	25	4590	2065	<b>7.392 €</b>
	J17R-299459BC	27,58	4590	2360	<b>10.460 €</b>	J17R-299459BS	27	4590	2265	<b>7.774 €</b>
	J17R-299459CC	30,09	4590	2560	<b>10.841 €</b>	J17R-299459CS	30	4590	2465	<b>8.173 €</b>
J18	J18R-299479AC	26,21	4790	2160	<b>10.390 €</b>	J18R-299479AS	26	4790	2065	<b>7.597 €</b>
	J18R-299479BC	28,83	4790	2360	<b>10.778 €</b>	J18R-299479BS	29	4790	2265	<b>7.987 €</b>
	J18R-299479CC	31,45	4790	2560	<b>11.051 €</b>	J18R-299479CS	31	4790	2465	<b>8.379 €</b>
J19	J19R-299499AC	27,34	4990	2160	<b>10.703 €</b>	J19R-299499AS	27	4990	2065	<b>7.797 €</b>
	J19R-299499BC	30,07	4990	2360	<b>11.124 €</b>	J19R-299499BS	30	4990	2265	<b>8.198 €</b>
	J19R-299499CC	32,81	4990	2560	<b>11.378 €</b>	J19R-299499CS	33	4990	2465	<b>8.603 €</b>

100	Largo - Length (L)																		
	1430	1630	1830	2030	2230	2430	2630	2830	3030	3230	3430	3630	3830	4030	4230	4430	4630	4830	5030
Fondo - Depth mm 3030	H1	H2	H3	H4	H5	H6	H7	H8	H9	H10	H11	H12	H13	H14	H15	H16	H17	H18	H19

100	CON suelo - WITH floor panel					SIN suelo - WITHOUT floor panel				
	COD	m³	L	H	€	COD	m³	L	H	€
J1	J1C-303143AC	6,96	1430	2200	<b>5.104 €</b>	J1C-303143AS	6,91	1430	2085	<b>4.319 €</b>
	J1C-303143BC	7,66	1430	2400	<b>5.368 €</b>	J1C-303143BS	7,61	1430	2285	<b>4.576 €</b>
	J1C-303143CC	8,35	1430	2600	<b>5.622 €</b>	J1C-303143CS	8,3	1430	2485	<b>4.835 €</b>
J2	J2C-303163AC	8,09	1630	2200	<b>5.446 €</b>	J2C-303163AS	8,03	1630	2085	<b>4.532 €</b>
	J2C-303163BC	8,9	1630	2400	<b>5.705 €</b>	J2C-303163BS	8,84	1630	2285	<b>4.797 €</b>
	J2C-303163CC	9,71	1630	2600	<b>5.970 €</b>	J2C-303163CS	9,65	1630	2485	<b>5.068 €</b>
J3	J3C-303183AC	9,23	1830	2200	<b>5.778 €</b>	J3C-303183AS	9,16	1830	2085	<b>4.742 €</b>
	J3C-303183BC	10,15	1830	2400	<b>6.057 €</b>	J3C-303183BS	10,08	1830	2285	<b>5.017 €</b>
	J3C-303183CC	11,07	1830	2600	<b>6.330 €</b>	J3C-303183CS	11	1830	2485	<b>5.296 €</b>
J4	J4C-303203AC	10,36	2030	2200	<b>6.109 €</b>	J4C-303203AS	10,28	2030	2085	<b>4.952 €</b>
	J4C-303203BC	11,39	2030	2400	<b>6.402 €</b>	J4C-303203BS	11,32	2030	2285	<b>5.245 €</b>
	J4C-303203CC	12,43	2030	2600	<b>6.679 €</b>	J4C-303203CS	12,35	2030	2485	<b>5.522 €</b>
J5	J5C-303223AC	11,49	2230	2200	<b>6.449 €</b>	J5C-303223AS	11,4	2230	2085	<b>5.163 €</b>
	J5C-303223BC	12,64	2230	2400	<b>6.741 €</b>	J5C-303223BS	12,55	2230	2285	<b>5.463 €</b>
	J5C-303223CC	13,79	2230	2600	<b>7.241 €</b>	J5C-303223CS	13,7	2230	2485	<b>5.760 €</b>
J6	J6C-303243AC	12,62	2430	2200	<b>6.773 €</b>	J6C-303243AS	12,53	2430	2085	<b>5.372 €</b>
	J6C-303243BC	13,88	2430	2400	<b>7.284 €</b>	J6C-303243BS	13,79	2430	2285	<b>5.677 €</b>
	J6C-303243CC	15,15	2430	2600	<b>7.597 €</b>	J6C-303243CS	15,05	2430	2485	<b>5.997 €</b>
J7	J7C-303263AC	13,75	2630	2200	<b>7.316 €</b>	J7C-303263AS	13,65	2630	2085	<b>5.579 €</b>
	J7C-303263BC	15,13	2630	2400	<b>7.629 €</b>	J7C-303263BS	15,03	2630	2285	<b>5.898 €</b>
	J7C-303263CC	16,5	2630	2600	<b>7.960 €</b>	J7C-303263CS	16,4	2630	2485	<b>6.221 €</b>
J8	J8C-303283AC	14,89	2830	2200	<b>7.650 €</b>	J8C-303283AS	14,77	2830	2085	<b>5.786 €</b>
	J8C-303283BC	16,37	2830	2400	<b>7.981 €</b>	J8C-303283BS	16,26	2830	2285	<b>6.123 €</b>
	J8C-303283CC	17,86	2830	2600	<b>8.165 €</b>	J8C-303283CS	17,75	2830	2485	<b>6.460 €</b>
J9	J9C-303303AC	16,02	3030	2200	<b>8.139 €</b>	J9C-303303AS	16	3030	2085	<b>6.167 €</b>
	J9C-303303BC	17,62	3030	2400	<b>8.333 €</b>	J9C-303303BS	18	3030	2285	<b>6.509 €</b>
	J9C-303303CC	19,22	3030	2600	<b>8.671 €</b>	J9C-303303CS	19	3030	2485	<b>7.047 €</b>
J10	J10C-303323AC	17,15	3230	2200	<b>8.342 €</b>	J10C-303323AS	17	3230	2085	<b>6.386 €</b>
	J10C-303323BC	18,86	3230	2400	<b>8.673 €</b>	J10C-303323BS	19	3230	2285	<b>6.738 €</b>
	J10C-303323CC	20,58	3230	2600	<b>9.023 €</b>	J10C-303323CS	20	3230	2485	<b>7.287 €</b>
J11	J11C-303343AC	18,28	3430	2200	<b>8.668 €</b>	J11C-303343AS	18	3430	2085	<b>6.603 €</b>
	J11C-303343BC	20,11	3430	2400						



80	Largo - Length (L)																		
	1390	1590	1790	1990	2190	2390	2590	2790	2990	3190	3390	3590	3790	3990	4190	4390	4590	4790	4990
Fondo - Depth mm 3190	K1	K2	K3	K4	K5	K6	K7	K8	K9	K10	K11	K12	K13	K14	K15	K16	K17	K18	K19

80	CON suelo - WITH floor panel					SIN suelo - WITHOUT floor panel				
	COD	m³	L	H	€	COD	m³	L	H	€
K1	K1R-319139AC	7,45	1390	2160	<b>4.924 €</b>	K1R-319139AS	7,4	1390	2065	<b>4.098 €</b>
	K1R-319139BC	8,2	1390	2360	<b>5.169 €</b>	K1R-319139BS	8,14	1390	2265	<b>4.346 €</b>
	K1R-319139CC	8,94	1390	2560	<b>5.412 €</b>	K1R-319139CS	8,89	1390	2465	<b>4.591 €</b>
K2	K2R-319159AC	8,67	1590	2160	<b>5.258 €</b>	K2R-319159AS	8,6	1590	2065	<b>4.296 €</b>
	K2R-319159BC	9,53	1590	2360	<b>5.516 €</b>	K2R-319159BS	9,47	1590	2265	<b>4.551 €</b>
	K2R-319159CC	10,4	1590	2560	<b>5.773 €</b>	K2R-319159CS	10,33	1590	2465	<b>4.809 €</b>
K3	K3R-319179AC	9,88	1790	2160	<b>5.591 €</b>	K3R-319179AS	9,8	1790	2065	<b>4.502 €</b>
	K3R-319179BC	10,87	1790	2360	<b>5.853 €</b>	K3R-319179BS	10,79	1790	2265	<b>4.761 €</b>
	K3R-319179CC	11,85	1790	2560	<b>6.118 €</b>	K3R-319179CS	11,78	1790	2465	<b>5.033 €</b>
K4	K4R-319199AC	11,09	1990	2160	<b>5.925 €</b>	K4R-319199AS	11,01	1990	2065	<b>4.697 €</b>
	K4R-319199BC	12,2	1990	2360	<b>6.195 €</b>	K4R-319199BS	12,12	1990	2265	<b>4.978 €</b>
	K4R-319199CC	13,31	1990	2560	<b>6.478 €</b>	K4R-319199CS	13,22	1990	2465	<b>5.245 €</b>
K5	K5R-319219AC	12,3	2190	2160	<b>6.250 €</b>	K5R-319219AS	12,21	2190	2065	<b>4.901 €</b>
	K5R-319219BC	13,53	2190	2360	<b>6.535 €</b>	K5R-319219BS	13,44	2190	2265	<b>5.181 €</b>
	K5R-319219CC	14,76	2190	2560	<b>6.820 €</b>	K5R-319219CS	14,67	2190	2465	<b>5.473 €</b>
K6	K6R-319239AC	13,51	2390	2160	<b>6.591 €</b>	K6R-319239AS	13,41	2390	2065	<b>5.098 €</b>
	K6R-319239BC	14,87	2390	2360	<b>6.889 €</b>	K6R-319239BS	14,76	2390	2265	<b>5.389 €</b>
	K6R-319239CC	16,22	2390	2560	<b>7.178 €</b>	K6R-319239CS	16,12	2390	2465	<b>5.685 €</b>
K7	K7R-319259AC	14,73	2590	2160	<b>6.924 €</b>	K7R-319259AS	14,62	2590	2065	<b>5.299 €</b>
	K7R-319259BC	16,2	2590	2360	<b>7.227 €</b>	K7R-319259BS	16,09	2590	2265	<b>5.604 €</b>
	K7R-319259CC	17,67	2590	2560	<b>7.594 €</b>	K7R-319259CS	17,56	2590	2465	<b>5.908 €</b>
K8	K8R-319279AC	15,94	2790	2160	<b>7.249 €</b>	K8R-319279AS	15,82	2790	2065	<b>5.495 €</b>
	K8R-319279BC	17,53	2790	2360	<b>7.635 €</b>	K8R-319279BS	17,41	2790	2265	<b>5.818 €</b>
	K8R-319279CC	19,13	2790	2560	<b>7.940 €</b>	K8R-319279CS	19,01	2790	2465	<b>6.125 €</b>
K9	K9R-319299AC	17,15	2990	2160	<b>7.811 €</b>	K9R-319299AS	17,02	2990	2065	<b>5.868 €</b>
	K9R-319299BC	18,86	2990	2360	<b>8.139 €</b>	K9R-319299BS	18,74	2990	2265	<b>6.196 €</b>
	K9R-319299CC	20,58	2990	2560	<b>8.454 €</b>	K9R-319299CS	20,45	2990	2465	<b>6.512 €</b>
K10	K10R-319319AC	18,36	3190	2160	<b>11.021 €</b>	K10R-319319AS	18	3190	2065	<b>7.997 €</b>
	K10R-319319BC	20,2	3190	2360	<b>11.450 €</b>	K10R-319319BS	20	3190	2265	<b>8.409 €</b>
	K10R-319319CC	22,03	3190	2560	<b>11.733 €</b>	K10R-319319CS	22	3190	2465	<b>8.834 €</b>
K11	K11R-319339AC	19,57	3390	2160	<b>11.345 €</b>	K11R-319339AS	19	3390	2065	<b>8.200 €</b>
	K11R-319339BC	21,53	3390	2360	<b>11.776 €</b>	K11R-319339BS	21	3390	2265	<b>8.625 €</b>
	K11R-319339CC	23,49	3390	2560	<b>12.064 €</b>	K11R-319339CS	23	3390	2465	<b>9.044 €</b>
K12	K12R-319359AC	20,79	3590	2160	<b>11.668 €</b>	K12R-319359AS	21	3590	2065	<b>8.401 €</b>
	K12R-319359BC	22,86	3590	2360	<b>12.107 €</b>	K12R-319359BS	23	3590	2265	<b>8.833 €</b>
	K12R-319359CC	24,94	3590	2560	<b>12.412 €</b>	K12R-319359CS	25	3590	2465	<b>9.266 €</b>
K13	K13R-319379AC	22	3790	2160	<b>11.993 €</b>	K13R-319379AS	22	3790	2065	<b>8.590 €</b>
	K13R-319379BC	24,2	3790	2360	<b>12.449 €</b>	K13R-319379BS	24	3790	2265	<b>9.048 €</b>
	K13R-319379CC	26,4	3790	2560	<b>12.746 €</b>	K13R-319379CS	26	3790	2465	<b>9.490 €</b>
K14	K14R-319399AC	23,21	3990	2160	<b>12.327 €</b>	K14R-319399AS	23	3990	2065	<b>8.798 €</b>
	K14R-319399BC	25,53	3990	2360	<b>12.776 €</b>	K14R-319399BS	25	3990	2265	<b>9.262 €</b>
	K14R-319399CC	27,85	3990	2560	<b>13.100 €</b>	K14R-319399CS	28	3990	2465	<b>9.709 €</b>
K15	K15R-319419AC	24,42	4190	2160	<b>12.648 €</b>	K15R-319419AS	24	4190	2065	<b>9.008 €</b>
	K15R-319419BC	26,86	4190	2360	<b>13.100 €</b>	K15R-319419BS	27	4190	2265	<b>9.465 €</b>
	K15R-319419CC	29,31	4190	2560	<b>13.445 €</b>	K15R-319419CS	29	4190	2465	<b>9.951 €</b>
K16	K16R-319439AC	25,63	4390	2160	<b>12.966 €</b>	K16R-319439AS	25	4390	2065	<b>9.195 €</b>
	K16R-319439BC	28,2	4390	2360	<b>13.456 €</b>	K16R-319439BS	28	4390	2265	<b>9.673 €</b>
	K16R-319439CC	30,76	4390	2560	<b>13.794 €</b>	K16R-319439CS	31	4390	2465	<b>10.174 €</b>
K17	K17R-319459AC	26,85	4590	2160	<b>13.271 €</b>	K17R-319459AS	27	4590	2065	<b>9.406 €</b>
	K17R-319459BC	29,53	4590	2360	<b>13.764 €</b>	K17R-319459BS	29	4590	2265	<b>9.891 €</b>
	K17R-319459CC	32,21	4590	2560	<b>14.130 €</b>	K17R-319459CS	32	4590	2465	<b>10.386 €</b>
K18	K18R-319479AC	28,06	4790	2160	<b>13.615 €</b>	K18R-319479AS	28	4790	2065	<b>9.609 €</b>
	K18R-319479BC	30,86	4790	2360	<b>14.106 €</b>	K18R-319479BS	31	4790	2265	<b>10.114 €</b>
	K18R-319479CC	33,67	4790	2560	<b>14.471 €</b>	K18R-319479CS	33	4790	2465	<b>10.603 €</b>
K19	K19R-319499AC	29,27	4990	2160	<b>13.916 €</b>	K19R-319499AS	29	4990	2065	<b>9.810 €</b>
	K19R-319499BC	32,2	4990	2360	<b>14.443 €</b>	K19R-319499BS	32	4990	2265	<b>10.324 €</b>
	K19R-319499CC	35,12	4990	2560	<b>14.816 €</b>	K19R-319499CS	35	4990	2465	<b>10.836 €</b>

100	Largo - Length (L)																		
	1430	1630	1830	2030	2230	2430	2630	2830	3030	3230	3430	3630	3830	4030	4230	4430	4630	4830	5030
Fondo - Depth mm 3230	K1	K2	K3	K4	K5	K6	K7	K8	K9	K10	K11	K12	K13	K14	K15	K16	K17	K18	K19

100	CON suelo - WITH floor panel					SIN suelo - WITHOUT floor panel				
	COD	m³	L	H	€	COD	m³	L	H	€
K1	K1C-323143AC	7,45	1430	2200	<b>5.331 €</b>	K1C-323143AS	7,4	1430	2085	<b>4.489 €</b>
	K1C-323143BC	8,2	1430	2400	<b>5.592 €</b>	K1C-323143BS	8,14	1430	2285	<b>4.750 €</b>
	K1C-323143CC	8,94	1430	2600	<b>5.857 €</b>	K1C-323143CS	8,89	1430	2485	<b>5.014 €</b>
K2	K2C-323163AC	8,67	1630	2200	<b>5.673 €</b>	K2C-323163AS	8,6	1630	2085	<b>4.708 €</b>
	K2C-323163BC	9,53	1630	2400	<b>5.957 €</b>	K2C-323163BS	9,47	1630	2285	<b>4.975 €</b>
	K2C-323163CC	10,4	1630	2600	<b>6.235 €</b>	K2C-323163CS	10,33	1630	2485	<b>5.257 €</b>
K3	K3C-323183AC	9,88	1830	2200	<b>6.027 €</b>	K3C-323183AS	9,8	1830	2085	<b>4.916 €</b>
	K3C-323183BC	10,87	1830	2400	<b>6.308 €</b>	K3C-323183BS	10,79	1830	2285	<b>5.203 €</b>
	K3C-323183CC	11,85	1830	2600	<b>6.601 €</b>	K3C-323183CS	11,78	1830	2485	<b>5.496 €</b>
K4	K4C-323203AC	11,09	2030	2200	<b>6.368 €</b>	K4C-323203AS	11,01	2030	2085	<b>5.137 €</b>
	K4C-323203BC	12,2	2030	2400	<b>6.671 €</b>	K4C-323203BS	12,12	2030	2285	<b>5.437 €</b>
	K4C-323203CC	13,31	2030	2600	<b>7.167 €</b>	K4C-323203CS	13,22	2030	2485	<b>5.728 €</b>
K5	K5C-323223AC	12,3	2230	2200	<b>6.725 €</b>	K5C-323223AS	12,21	2230	2085	<b>5.349 €</b>
	K5C-323223BC	13,53	2230	2400	<b>7.239 €</b>	K5C-323223BS	13,44	2230	2285	<b>5.654 €</b>
	K5C-323223CC	14,76	2230	2600	<b>7.550 €</b>	K5C-323223CS	14,67	2230	2485	<b>5.963 €</b>
K6	K6C-323243AC	13,51	2430	2200	<b>7.268 €</b>	K6C-323243AS	13,41	2430	2085	<b>5.568 €</b>
	K6C-323243BC	14,87	2430	2400	<b>7.585 €</b>	K6C-323243BS	14,76	2430	2285	<b>5.889 €</b>
	K6C-323243CC	16,22	2430	2600	<b>7.921 €</b>	K6C-323243CS	16,12	2430	2485	<b>6.214 €</b>
K7	K7C-323263AC	14,73	2630	2200	<b>7.622 €</b>	K7C-323263AS	14,62	2630	2085	<b>5.781 €</b>
	K7C-323263BC	16,2	2630	2400	<b>7.950 €</b>	K7C-323263BS	16,09	2630	2285	<b>6.115 €</b>
	K7C-323263CC	17,67	2630	2600	<b>8.130 €</b>	K7C-323263CS	17,56	2630	2485	<b>6.440 €</b>
K8	K8C-323283AC	15,94	2830	2200	<b>7.968 €</b>	K8C-323283AS	15,82	2830	2085	<b>5.997 €</b>
	K8C-323283BC	17,53	2830	2400	<b>8.154 €</b>	K8C-323283BS	17,41	2830	2285	<b>6.340 €</b>
	K8C-323283CC	19,13	2830	2600	<b>8.487 €</b>	K8C-323283CS	19,01	2830	2485	<b>6.889 €</b>
K9	K9C-323303AC	17,15	3030	2200	<b>8.334 €</b>	K9C-323303AS	17,02	3030	2085	<b>6.388 €</b>
	K9C-323303BC	18,86	3030	2400	<b>8.688 €</b>	K9C-323303BS	18,74	3030	2285	<b>6.739 €</b>
	K9C-323303CC	20,58	3030	2600	<b>9.018 €</b>	K9C-323303CS	20,45	3030	2485	<b>7.293 €</b>
K10	K10C-323323AC	18,36	3230	2200	<b>8.881 €</b>	K10C-323323AS	18	3230	2085	<b>6.633 €</b>
	K10C-323323BC	20,2	3230	2400	<b>9.221 €</b>	K10C-323323BS	20	3230	2285	<b>7.099 €</b>



Estanterías NO incluidas  
Shelves NOT included

Mecanismo de ganchos excéntricos de doble efecto (gira y recoge)

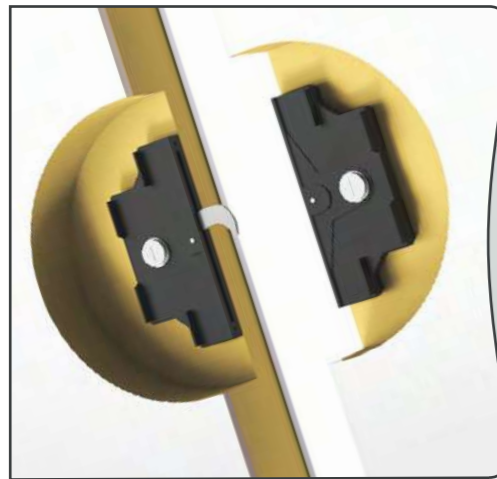

Double effect eccentric hooks mechanism (turns and locks)

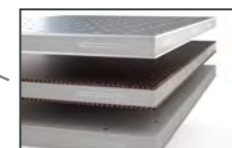
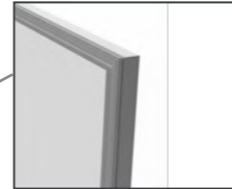
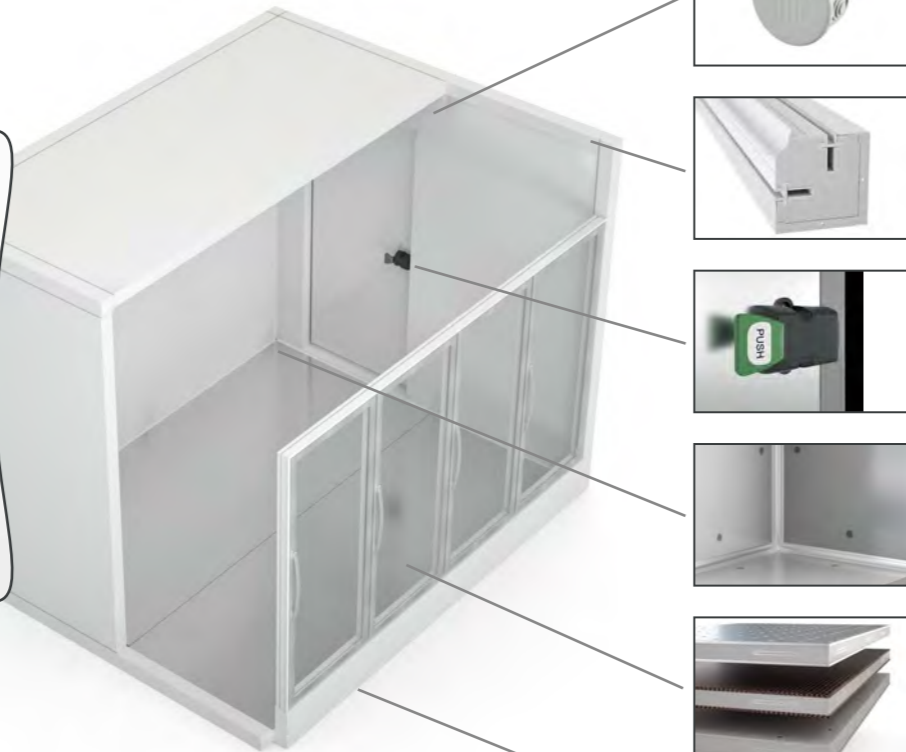

**Aislamiento:**

- Espuma rígida de poliuretano con formulación libre de CFC e inyectado a alta presión
- Densidad 45 Kg. / m<sup>2</sup>
- Coeficiente de conductividad térmica 0.022W/mK a 10°C. (Sin envejecimiento)

**Insulation:**

- Rigid polyurethane foam, CFC-free, injected at high pressure.
- Density 45kg/m<sup>2</sup>.
- Thermal conductivity coefficient 0.022W/mK at 10°C. (Without ageing).

**Paneles**

- Dos espesores: 80 y 100 mm.

**Panels**

- Two thickness: 80 and 100 mm.

**Revestimiento:**

- Revestimiento estándar de chapa de acero galvanizado prelacado poliéster, con film de protección pelable.
- Color blanco pirineo.
- Calidad alimentaria.

**Cladding:**

- Galvanized steel cladding pre-lacquered with polyester, with peelable protective film, as standard.
- Colour white, "blanco pirineo".
- Food grade.

**Sistema de Unión:**

- Mecanismo de ganchos excéntricos de alta resistencia y doble efecto (gira y recoge), colocados en carcasas de ABS. El conjunto está pensado para trabajar de dos maneras: engancha y puede ser enganchado.

**Connecting System:**

- High resistance and double effect eccentric hooks mechanism (turns and locks), installed in ABS housings. The combination is designed to work in two ways: it engages and can be hooked.

**Columnas verticales y horizontales:**

- Columnas perimetrales que incluyen un innovador perfil sanitario con labio flexible que se adapta al panel consiguiendo una unión perfecta de gran calidad y revestidas en su exterior con la misma chapa utilizada en los paneles, consiguiendo así una línea estética regular en toda la cámara.
- Todo el conjunto está inyectado en su interior con poliuretano de las mismas características y densidad que el resto de paneles.

**Vertical and horizontal columns:**

- Perimeter columns with innovative flexible sanitary lip seal that adapts to fit the panel, combining high quality and an exterior coating made with the same metal sheeting as used to make the panels, thus achieving a uniform appearance throughout the room.
- Everything is injected with polyurethane and has the same characteristics and density as the rest of the panels.

**Puerta ciega**

- Marco perimetral exterior de aluminio anodizado anticorrosión
- Bultete de estanqueidad.
- Huevo de luz 1850x800 mm
- Resistencia eléctrica antiescarcha colocada en el marco del panel de puerta.
- Tanto el panel puerta como la puerta están inyectados en su interior con el mismo aislamiento del resto de paneles.
- Bisagras con regulación y pasador inoxidable.
- Cierre con llave y con punto de presión.

**Solid door:**

- Exterior perimeter frame made of anodized anti-corrosion aluminium.
- Sealing gasket.
- A light shaft of 1850x800 mm.
- Frost preventi on electric resistance placed on door panel frame.
- Both the door panel and the door are injected with the same insulation as the rest of the panels.
- Adjustable hinges with stainless steel pin.
- Locks with key and pressure point.

**Puerta cristal**

- Marco perimetral exterior de aluminio anodizado anticorrosión color plata.
- Bultete magnético de estanqueidad.
- Huevo de luz 1700x610mm en puerta
- Doble cristal en temperatura positiva: exterior 4mm templado, separador 20mm, interior 4mm bajo emisivo, Ug 1,1 W/(m<sup>2</sup>.K)
- Triple cristal en temperatura negativa: exterior 4mm templado bajo emisivo, separador 8mm, central 4mm, separador 8mm, interior 4mm bajo emisivo, Ug 0,9 W/(m<sup>2</sup>.K)
- Apertura a derechas (apertura a izquierda bajo pedido)
- Cristales calefactados en temperatura negativa
- Soporte de puertas en acero inoxidable.
- Tirador superpuesto.
- Muelle de retorno automático, con fuerza de retorno ajustable.

**Glass door:**

- Perimetral exterior frame, made of aluminium and anodized anti-corrosion, silver colour
- Magnetic sealing gasket.
- Light shaft of 1700x610 mm in door.
- Double glazed positive temperatures: exterior tempered glass 4mm, gas 20mm, interior low-e glass 4mm, Ug 1,1 W/(m<sup>2</sup>.K)
- Triple glazed negative temperatures: exterior low-e tempered glass 4mm, gas 8mm, central clear glass 4mm, gas 8mm, interior low-e glass 4mm, Ug 0,9 W/(m<sup>2</sup>.K)
- Right opening( optional: left opening)
- Heated glass negative temperature
- Stainless steel door support.
- Superimposed handle.
- Adjustable automatic return spring

**Marco**

- Marco perimetral exterior de aluminio y PVC anodizado anticorrosión color plata
- Resistencia en el perímetro.

**Frame**

- Perimetral exterior frame, made of aluminium and anodized anti-corrosion PVC, silver colour
- Frame heating resistance

**Iluminación**

- LED

**Lighting**

- LED

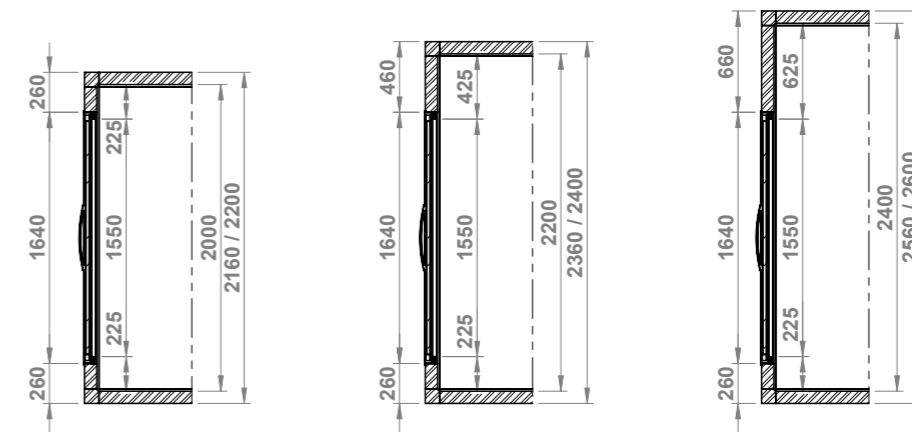
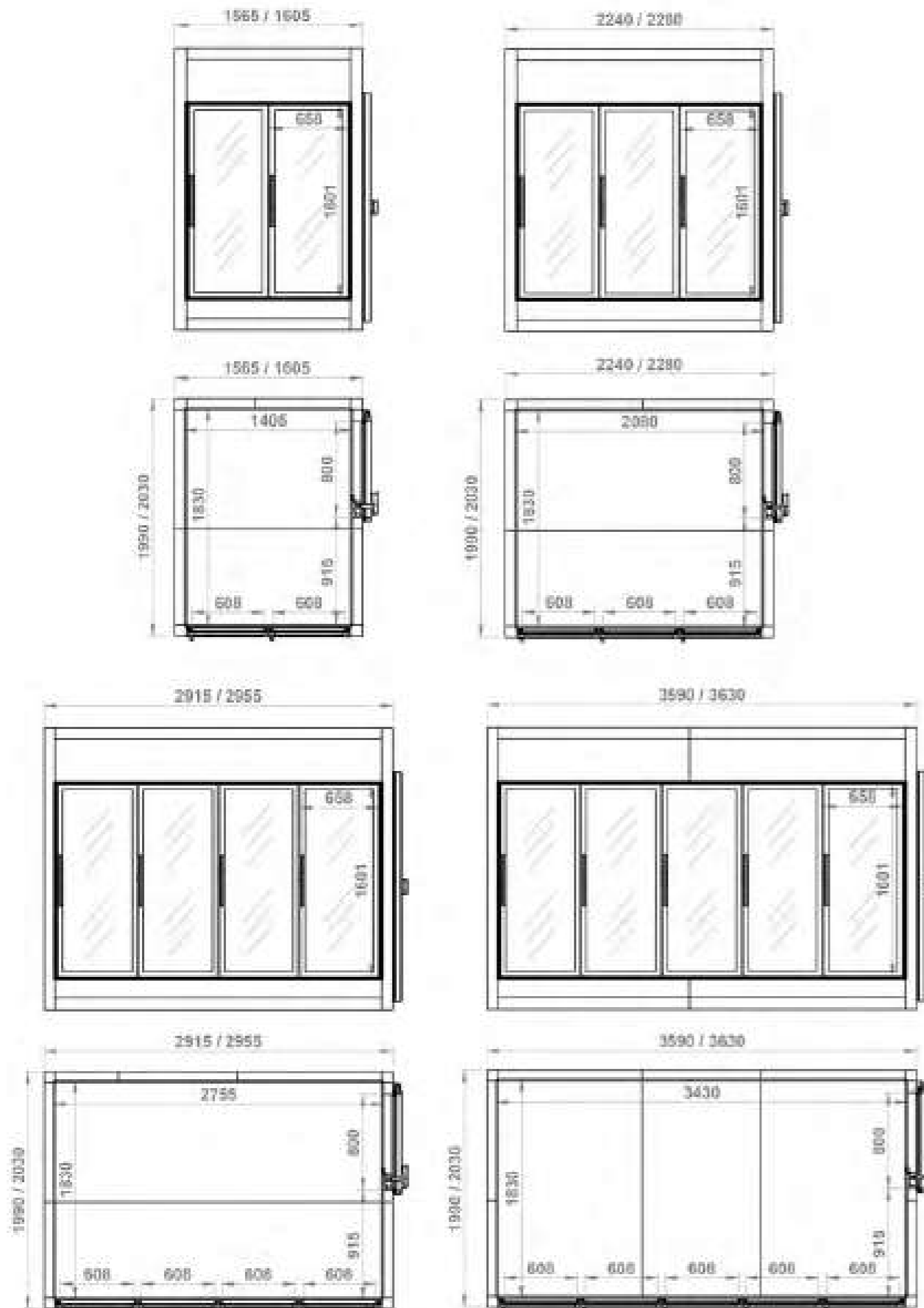

Estanterías **NO** incluidas  
Shelves **NOT** included

	espesor Thickness mm	largo Length mm	alto height mm	fondo depth mm	capacidad capacity m <sup>3</sup>	puertas doors	11/2 puertas half doors	€	
refrigeración - chiller	RFM2R-PC-A	80	1565	2160	1990	5,14	2	1	6.344 €
	RFM2R-PC-B	80	1565	2360	1990	5,62	2	1	6.592 €
	RFM2R-PC-C	80	1565	2560	1990	6,18	2	1	6.834 €
	RFM3R-PC-A	80	2240	2160	1990	7,61	3	1	7.910 €
	RFM3R-PC-B	80	2240	2360	1990	8,32	3	1	8.145 €
	RFM3R-PC-C	80	2240	2560	1990	9,15	3	1	8.379 €
	RFM4R-PC-A	80	2915	2160	1990	10,08	4	1	9.286 €
	RFM4R-PC-B	80	2915	2360	1990	11,02	4	1	9.558 €
	RFM4R-PC-C	80	2915	2560	1990	12,12	4	1	9.818 €
	RFM5R-PC-A	80	3590	2160	1990	15,55	5	1	10.359 €
RFM5R-PC-B	80	3590	2360	1990	13,72	5	1	10.659 €	
RFM5R-PC-C	80	3590	2560	1990	15,09	5	1	10.958 €	
congelados - freezer	RFM2C-PC-A	100	1605	2200	2030	5,14	2	1	7.104 €
	RFM2C-PC-B	100	1605	2400	2030	5,62	2	1	7.364 €
	RFM2C-PC-C	100	1605	2600	2030	6,18	2	1	7.625 €
	RFM3C-PC-A	100	2280	2200	2030	7,61	3	1	8.886 €
	RFM3C-PC-B	100	2280	2400	2030	8,32	3	1	9.132 €
	RFM3C-PC-C	100	2280	2600	2030	9,15	3	1	9.382 €
	RFM4C-PC-A	100	2295	2200	2030	10,08	4	1	10.967 €
	RFM4C-PC-B	100	2295	2400	2030	11,02	4	1	11.247 €
	RFM4C-PC-C	100	2295	2600	2030	12,12	4	1	11.532 €
	RFM5C-PC-A	100	3630	2200	2030	15,55	5	1	12.528 €
RFM5C-PC-B	100	3630	2400	2030	13,72	5	1	12.848 €	
RFM5C-PC-C	100	3630	2600	2030	15,09	5	1	13.166 €	

### OPCIONES bajo pedido

- Otras calidades y colores para el revestimiento del panel tanto para el exterior como en el interior
- Suelo con acabado interior en acero inoxidable antideslizante
- Suelo con acabado blanco pirineo, igual al resto de paneles
- Equipo frigorífico
- Estanterías de aluminio y polietileno de fabricación propia.
- Resistencia eléctrica en cámaras de espesor 80 mm.
- Hacha de bombero
- Soporte hacha
- Alarma hombre atrapado
- Rampa para puerta abatible o corredera
- Rastres para separación entre el panel inferior y el suelo

### OPTIONS on request

- Other qualities and colors for the panel covering both for the exterior and interior
- Floor with non-slip stainless steel interior finish
- Floor with a white pyrenean finish, the same as the other panels
- Refrigeration equipment
- Self-made aluminum and polyethylene shelves.
- Electrical resistance in chambers of thickness 80 mm.
- Fire ax
- Ax support
- Trapped man alarm
- Ramp for swing or sliding door
- Tracks for separation between bottom panel and base floor



# Serie AFD

**ARMARIOS DESMONTABLES**  
*MODULAR REACH-IN*

**ARMARIOS DESMONTABLES PUERTAS CRISTAL**  
*MODULAR REACH-IN WITH GLASS DOORS*





CORECO presenta sus nuevos Armarios Frigoríficos Desmontables, GAMA AFD.

CORECO presents its new AFD Range of Modular Reach-In Refrigerator.

Empleamos para su construcción la misma filosofía y materiales que para nuestras Cámaras frigoríficas RFM

Our modular reach-in refrigerator are manufactured using the same philosophy and materials as our RFM cold rooms.



### GENERALES

- Espuma rígida de poliuretano con formulación libre de CFC e inyectado a alta presión
- Densidad 45 Kg. / m<sup>2</sup>
- Coeficiente de conductividad térmica 0.022W/mK a 10°C. (Sin envejecimiento)
- Espesor aislante, 80 mm
- Revestimiento estándar de chapa de acero galvanizado prelacado poliéster, con film de protección pelable.
- Color blanco pirineo.
- Calidad alimentaria.
- Mecanismo de ganchos excéntricos de alta resistencia y doble efecto (gira y recoge), colocados en carcasas de ABS. El conjunto está pensado para trabajar de dos maneras: engancha y puede ser enganchado.
- Columnas perimetrales que incluyen un innovador perfil sanitario con labio flexible que se adapta al panel consiguiendo una unión perfecta de gran calidad y revestidas en su exterior con la misma chapa utilizada en los paneles, consiguiendo así una línea estética regular en toda la cámara.
- Todo el conjunto está inyectado en su interior con poliuretano de las mismas características y densidad que el resto de paneles.
- Burlete magnético de estanqueidad.
- Hueco de luz 1700 x 610 mm en puerta 1/1
- Hueco de luz 800 x 610 mm en puerta 1/2
- Resistencia antiescarcha, colocada en el marco del panel puerta en armarios de Mantenimiento de Congelados
- Válvula de compensación de presiones en armarios de Mantenimiento de Congelados
- Tanto el panel puerta como la puerta están inyectados en su interior con el mismo aislamiento del resto de paneles.
- Cremalleras de acero inoxidable con paso de 70 mm
- Parrillas y guías extraíbles
- Parrillas de acero plastificadas
- De serie, 4 niveles de estantes por cuerpo (50kg. carga máxima por nivel)
- Puerta 1/1, máximo 23 niveles por cuerpo, puerta 1/2, máximo 21 niveles por cuerpo
- LED

### PUERTA CRISTAL

- Marco perimetral exterior de aluminio y PVC anodizado anticorrosión color plata
- Doble cristal en temperatura POSITIVA: vidrio exterior 4mm templado, separador 20mm, vidrio interior 4mm bajo emisivo.
- Triple cristal en temperatura NEGATIVA: vidrio exterior 4mm templado bajo emisivo, separador 8mm, vidrio central 4mm, separador 8mm, vidrio interior 4mm bajo emisivo.

### GENERAL

- Rigid polyurethane foam, CFC-free, injected at high pressure.
- Density 45kg/m<sup>2</sup>.
- Thermal conductivity coefficient 0.022W/mK at 10°C. (Without ageing)
- Isolation thickness, 80 mm
- Galvanized steel cladding pre-lacquered with polyester, with peelable protective film, as standard.
- Colour white, "blanco pirineo".
- Food grade.
- High resistance and double effect eccentric hooks mechanism (turns and locks), installed in ABS housings. The combination is designed to work in two ways: it engages and can be hooked.
- Standard 80 mm thickness, 100 mm on demand
- Perimeter columns with innovative flexible sanitary lip seal that adapts to fit the panel, combining high quality and an exterior coating made with the same metal sheeting as used to make the panels, thus achieving a uniform appearance throughout the room.
- Everything is injected with polyurethane and has the same characteristics and density as the rest of the panels.
- Magnetic sealing gasket.
- Light shaft of 1700 x 610 mm in 1/1 door.
- Light shaft of 800 x 610mm in 1/2 door.
- Frost prevention resistance installed on the door panel frame in frozen food storage reach-in refrigerators.
- Pressure compensation valve in frozen food storage reach-in refrigerators.
- Both the door panel and the door are injected with the same insulation as the rest of the panels.
- Stainless steel supports with 70mm intervals.
- Detachable wire shelves and rails.
- Plastic-coated stainless steel wire shelves.
- Standard, 4 shelves per section (load capacities up to 50kg. per level)
- 1/1 door, max 23 levels per section, 1/2 doors, max 21 levels per section.
- LED

### GLASS DOOR

- Perimetral exterior frame, made of aluminium and anodized anti-corrosion PVC, silver colour
- Double glazed POSITIVE temperatures: exterior tempered glass 4mm, gas 20mm, interior low-e glass 4mm.
- Triple glazed NEGATIVE temperatures: exterior low-e tempered glass 4mm, gas 8mm, central clear glass 4mm, gas 8mm, interior low-e glass 4mm





### De serie:

- Estantes de 600 x 400 mm.
- 2 estantes por nivel.
- 4 niveles de estantes por cuerpo.
- Separación mínima entre estantes 70 mm.
- Puertas apertura a izquierda.
- 1/2 Puertas apertura a derechas.
- Resistencia antiescarcha y válvula en mantenimiento de congelados.
- Iluminación interior.

### Opción:

- Elección de las aperturas de puertas y 1/2 puertas.
- Estantes intermedios
- Tirador con cerradura

### Standard:

- Shelves 600 x 400mm.
- 2 shelves per level.
- 4 shelves per section.
- Spacing between shelves 70mm minimum.
- Left door opening.
- 1/2 right door opening.
- No-frost resistance and valve in frozen reach-in units.
- Interior lighting

### Optional:

- Choice of door and 1/2 door openings.
- Intermediate shelves
- Locks with key

Armarios frigoríficos desmontables versátiles como nuestras cámaras, por lo que bajo presupuesto permiten otras opciones de construcción:

- Colocación de puertas tanto en el frontal como en la parte trasera.
- Sustitución de un panel de puertas por uno de pared vertical.
- Sin dotación interior (guías, parrillas y cremalleras)
- Construcción en diferentes alturas.
- Construcción en panel de espesor 80 o 100 mm.
- Puerta de cristal 1-1 o 1-2 en armarios de refrigeración

Modular reach-in refrigerators are as versatile as our rooms and offer low budget construction options:

- Positioning of doors on both the front and back.
- Replacing a door panel with a vertical wall panel.
- Without interior equipment (rails, wire shelves and supports).
- Different heights construction
- 80 or 100 mm thickness panel construction.
- Glass door 1-1 or 1-2 for chillers.

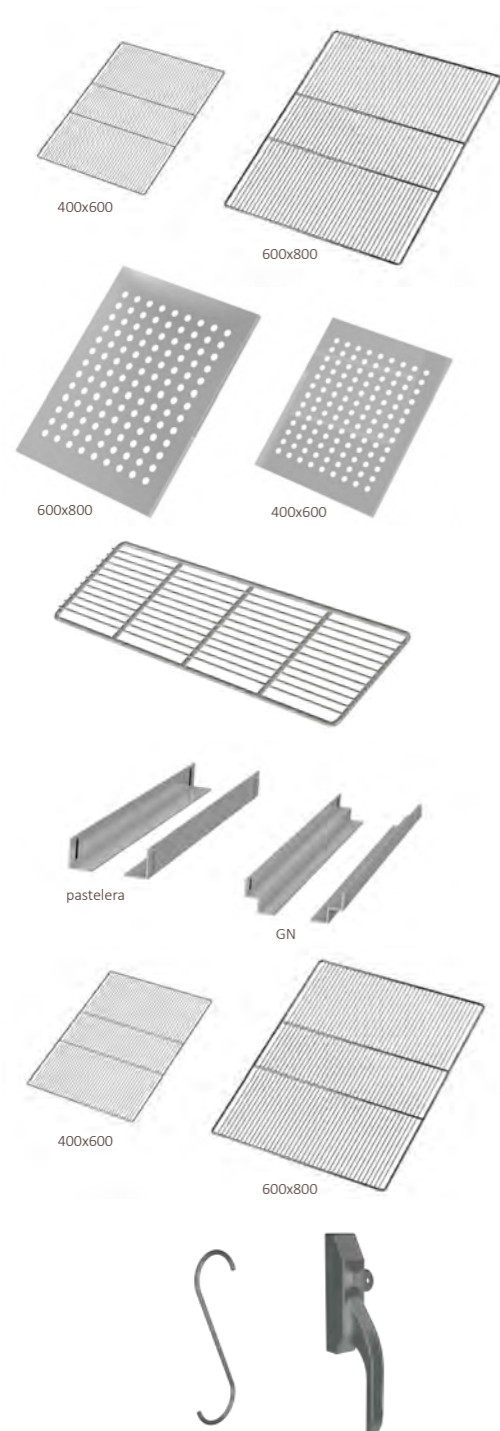

### ESTANTES / SHELVES

ARTÍCULO ITEM	DIMENSIONES MEASUREMENTS	ACABADO FINISH	€
PP6080	600 x 800	Ac. plastificado Plastic-coated	59 €
PP6040	600 x 400	Ac. plastificado Plastic-coated	31 €

### ESTANTES REFORZADOS EN ACERO INOX REINFORCED STAINLESS STEEL SHELVES

ARTÍCULO ITEM	DIMENSIONES MEASUREMENTS	ACABADO FINISH	€
PR6080	600 x 800	Ac. inoxidable Stainless steel	124 €
PR6040	600 x 400	Ac. inoxidable Stainless steel	85 €

### ESTANTES INTERMEDIOS INTERMEDIATE SHELVES

ARTÍCULO ITEM	DIMENSIONES MEASUREMENTS	ACABADO FINISH	€
P17619-AFD	763 x 190	Ac. plastificado Plastic-coated stainless steel	22 €

### JUEGO DE GUÍAS / SET OF RAILS

ARTÍCULO ITEM	DIMENSIONES MEASUREMENTS	ACABADO FINISH	€
L	Fondo 800	Ac. inoxidable Stainless steel	48 €
Z	Fondo 800	Ac. inoxidable Stainless steel	60 €

### GASTRONORM

ARTÍCULO ITEM	DIMENSIONES MEASUREMENTS	ACABADOS FINISH	€
GN 2/1	530X650	Ac. plastificado	59 €
GN 1/1	530X325	Ac. plastificado	30 €
GN 2/1	530X650	Ac. inoxidable	101 €
GN 1/1	530X325	Ac. inoxidable	64 €

### BARRAS CARNICERAS / MEAT RAILS

ARTÍCULO ITEM	PARA MODELO FOR MODEL	LONGITUD LENGTH	€
BC1	1 CUERPO / DOOR	610	191 €
GC	GANCHO CARNICERO / MEAT HOOKS		20 € x ud
TC	TIRADOR CON CERRADURA / LOCKS WITH KEY		48 € x ud

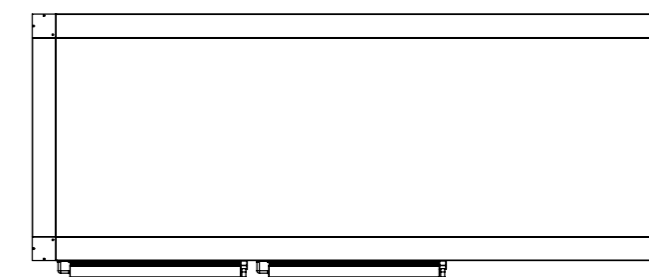
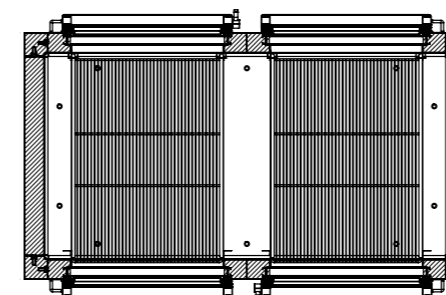

### CAMBIO DE PUERTA CIEGA A PUERTA CRISTAL REFRIGERACIÓN SOLID DOOR TO GLASS DOOR REFRIGERATION

ARTÍCULO ITEM	DIMENSIONES MEASUREMENTS	€
P1-1AFDVR	LUZ 610 x 1700	415 €
P1-2AFDVR	LUZ 610 x 800	250 €

Las puertas de cristal se suministrarán con iluminación led  
Glass doors supplied with LED lighting

CONFIGURACIÓN DE PUERTAS DOOR COMPOSITION

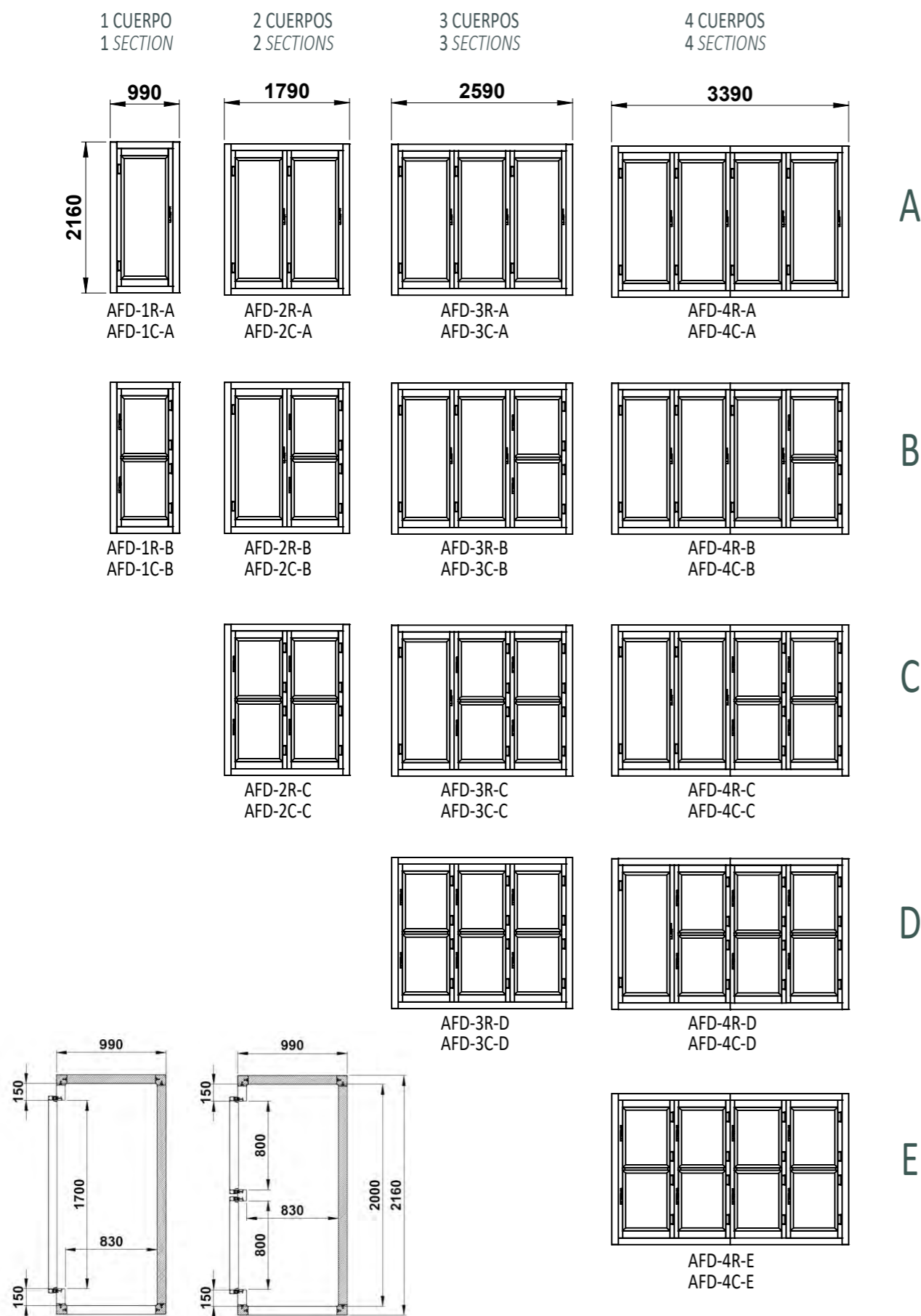

		largo length mm	alto height mm	fondo depth mm	capacidad capacity m <sup>3</sup>	puertas doors	1/2 puertas half doors	€
refrigeración - chiller	AFD-1R-A	990	2160	990	1.38	1	-	2.299 €
	AFD-1R-B	990	2160	990	1.38	-	2	2.653 €
	AFD-2R-A	1790	2160	990	2.71	2	-	3.711 €
	AFD-2R-B	1790	2160	990	2.71	1	2	4.065 €
	AFD-2R-C	1790	2160	990	2.71	-	4	4.419 €
	AFD-3R-A	2590	2160	990	4.03	3	-	5.038 €
	AFD-3R-B	2590	2160	990	4.03	2	2	5.384 €
	AFD-3R-C	2590	2160	990	4.03	1	4	5.742 €
	AFD-3R-D	2590	2160	990	4.03	-	6	6.094 €
	AFD-4R-A	3390	2160	990	5.36	4	-	6.358 €
	AFD-4R-B	3390	2160	990	5.36	3	2	6.712 €
	AFD-4R-C	3390	2160	990	5.36	2	4	7.067 €
congelados - freezer	AFD-4R-D	3390	2160	990	5.36	1	6	7.413 €
	AFD-4R-E	3390	2160	990	5.36	-	8	7.770 €
	AFD-1C-A	990	2160	990	1.38	1	-	2.745 €
	AFD-1C-B	990	2160	990	1.38	-	2	2.915 €
	AFD-2C-A	1790	2160	990	2.71	2	-	4.433 €
	AFD-2C-B	1790	2160	990	2.71	1	2	4.596 €
	AFD-2C-C	1790	2160	990	2.71	-	4	4.767 €
	AFD-3C-A	2590	2160	990	4.03	3	-	5.937 €
	AFD-3C-B	2590	2160	990	4.03	2	2	6.108 €
	AFD-3C-C	2590	2160	990	4.03	1	4	6.279 €
	AFD-3C-D	2590	2160	990	4.03	-	6	6.443 €
	AFD-4C-A	3390	2160	990	5.36	4	-	7.454 €
AFD-4C-B	3390	2160	990	5.36	3	2	7.617 €	
AFD-4C-C	3390	2160	990	5.36	2	4	7.789 €	
AFD-4C-D	3390	2160	990	5.36	1	6	7.959 €	
AFD-4C-E	3390	2160	990	5.36	-	8	8.124 €	

Armarios Frigoríficos Desmontables, GAMA AFD-PC., Ideales para la exposición de bebidas y alimentación.  
Recomendable para condiciones ambientales entre +10 y 33° C con un 65% de humedad relativa.

AFD-PC Range of Modular Reach-In Refrigerator, are perfect to exhibit drinks and foods  
Ready to work under ambient conditions between +10 and 33° C with a 65% relative humidity.



Estanterías **NO** incluidas en el precio del armario  
Shelves **NOT** included in the reach-in standard price



### GENERALES

- Espuma rígida de poliuretano con formulación libre de CFC e inyectado a alta presión
- Densidad 45 Kg. / m<sup>2</sup>
- Coeficiente de conductividad térmica 0.022W/mK a 10°C. (Sin envejecimiento)
- Espesor de 80 mm.
- Revestimiento estándar de chapa de acero galvanizado prelacado poliéster, con film de protección pelable.
- Color blanco pirineo.
- Calidad alimentaria.
- Mecanismo de ganchos excéntricos de alta resistencia y doble efecto (gira y recoge), colocados en carcasas de ABS. El conjunto está pensado para trabajar de dos maneras: engancha y puede ser enganchado.
- Columnas perimetrales que incluyen un innovador perfil sanitario con labio flexible que se adapta al panel consiguiendo una unión perfecta de gran calidad y revestidas en su exterior con la misma chapa utilizada en los paneles, consiguiendo así una línea estética regular en toda la cámara.
- Todo el conjunto está inyectado en su interior con poliuretano de las mismas características y densidad que el resto de paneles.
- LED

### MARCO ENCASTRADO

- Marco perimetral exterior de aluminio y PVC anodizado anticorrosión color plata
- Resistencia en el perímetro.

### PUERTA

- Marco perimetral exterior de aluminio anodizado anticorrosión color plata.
- Burlete magnético de estanqueidad.
- Hueco de luz 1700 x 610mm en puerta
- Doble cristal en temperatura positiva: exterior 4mm templado, separador 20mm, interior 4mm bajo emisivo, Ug 1,1 W/(m<sup>2</sup>.K)
- Triple cristal en temperatura negativa: exterior 4mm templado bajo emisivo, separador 8mm, central 4mm, separador 8mm, interior 4mm bajo emisivo, Ug 0,9 W/(m<sup>2</sup>.K)
- Apertura a derechas (apertura a izquierda bajo pedido)
- Cristales calefactados en temperatura negativa
- Soporte de puertas en acero inoxidable.
- Tirador superpuesto.
- Muelle de retorno automático, con fuerza de retorno ajustable.

### GENERAL

- Rigid polyurethane foam, CFC-free, injected at high pressure.
- Density 45kg/m<sup>2</sup>.
- Thermal conductivity coefficient 0.022W/mK at 10°C. (Without ageing).
- 80 mm isolation thickness
- Galvanized steel cladding pre-lacquered with polyester, with peelable protective film, as standard.
- Colour white, "blanco pirineo".
- Food grade.
- High resistance and double effect eccentric hooks mechanism (turns and locks), installed in ABS housings. The combination is designed to work in two ways: it engages and can be hooked.
- Perimeter columns with innovative flexible sanitary lip seal that adapts to fit the panel, combining high quality and an exterior coating made with the same metal sheeting as used to make the panels, thus achieving a uniform appearance throughout the room.
- Everything is injected with polyurethane and has the same characteristics and density as the rest of the panels.
- LED

### BUILT-IN FRAME

- Perimetral exterior frame, made of aluminium and anodized anti-corrosion PVC, silver colour
- Frame heating resistance

### DOOR

- Perimetral exterior frame, made of aluminium and anodized anti-corrosion, silver colour
- Magnetic sealing gasket.
- Light shaft of 1700 x 610 mm in door.
- Double glazed positive temperatures: exterior tempered glass 4mm, gas 20mm, interior low-e glass 4mm, Ug 1,1 W/(m<sup>2</sup>.K)
- Triple glazed negative temperatures: exterior low-e tempered glass 4mm, gas 8mm, central clear glass 4mm, gas 8mm, interior low-e glass 4mm, Ug 0,9 W/(m<sup>2</sup>.K)
- Right opening (optional: left opening)
- Heated glass negative temperature
- Stainless steel door support.
- Superimposed handle.
- Adjustable automatic return spring



Estanterías **NO** incluidas  
Shelves **NOT** included

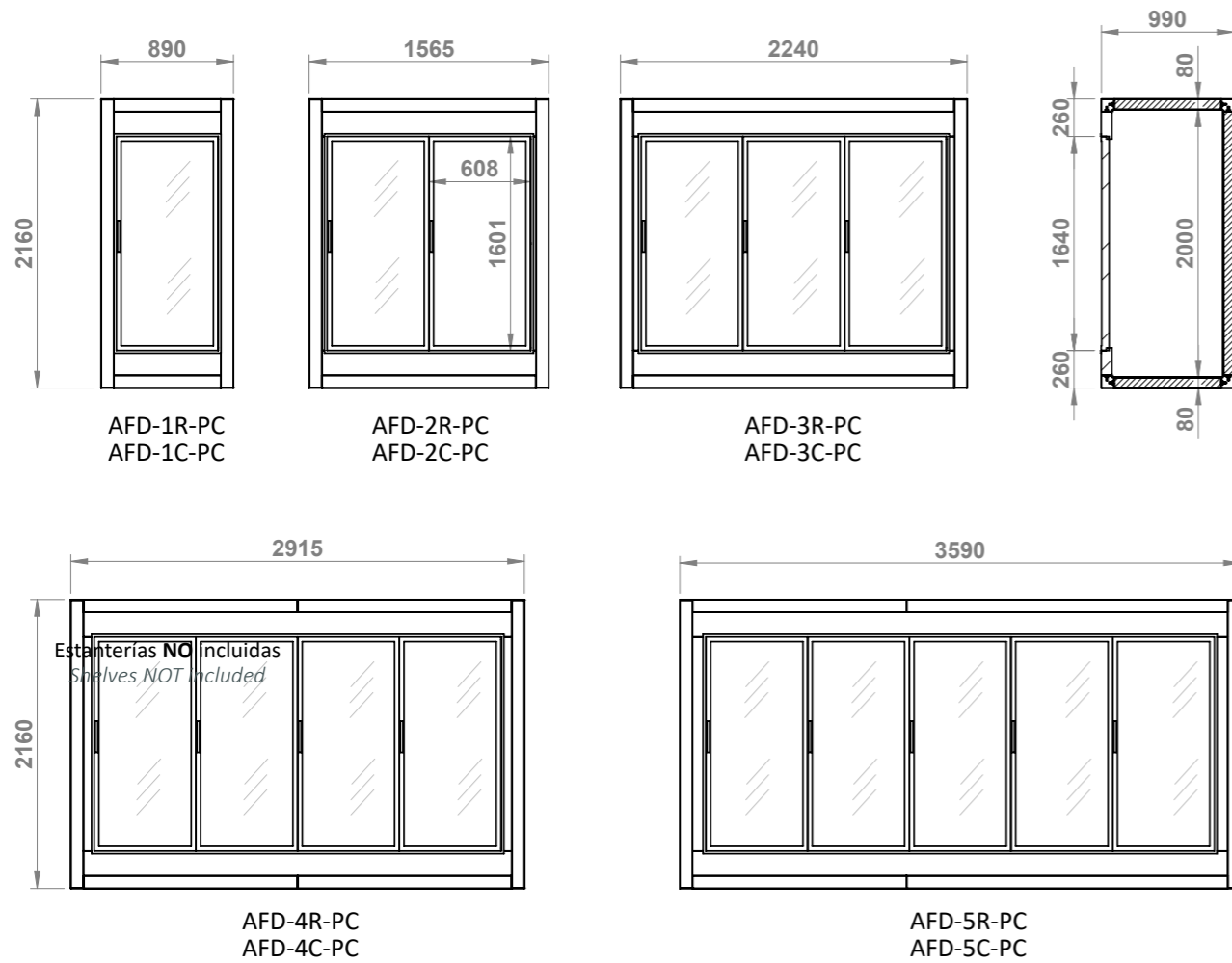

**De serie:**

- 1 estante base fijo de carga fijo.
- 4 estantes de carga móviles 600x665 regulables en altura (paso 80mm),
- inclinación (0°, 8° y 16°) y profundidad.
- Barandilla frontal de alambre plastificado blanco.
- Portaprecios.

**Standar:**

- 1 loading level fixed
- 4 moving shelves of loading 600x665 adjustable on height (space 80mm), inclination (0°, 8° y 16°) and depth.
- Front railing in white coating wire
- Price tag

**Opción:**

- Separador lateral blanco o cromado
- Barandilla frontal cromada o metacrilato

**Optional:**

- White or Chromed Side separator
- Chromed or Methacrylate front railing

módulo estantería shelves module	mod.	fondo depth mm	puertas doors uds	€
	ME1P600	600	1	1.144 €
	ME2P600	600	2	2.183 €
	ME3P600	600	3	3.202 €
	ME4P600	600	4	4.315 €
	ME5P600	600	5	5.390 €

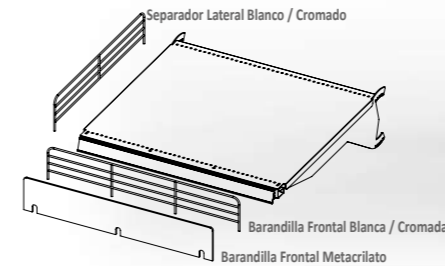

- Separación lateral, cada 1 cm.
- Lateral separation, every 1 cm.

Opcinal	Optional	€
separador lateral cromado	chromed lateral divider	37 €
barandilla frontal metacrilato	plexy front railing	37 €
barandilla frontal cromada	chromed front railing	37 €

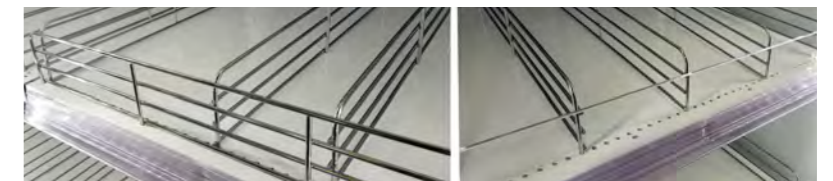

	largo Length mm	alto height mm	fondo depth mm	capacidad capacity m³	puertas doors	1/2 puertas half doors	€	
refrigeración - chiller	AFD-1R-PC	890	2160	990	1,21	1	0	3.585 €
	AFD-2R-PC	1565	2160	990	2,33	2	0	4.894 €
	AFD-3R-PC	2240	2160	990	3,48	3	0	6.199 €
	AFD-4R-PC	2915	2160	990	4,57	4	0	7.434 €
	AFD-5R-PC	3590	2160	990	5,69	5	0	8.340 €
congelados - freezer	AFD-1C-PC	890	2160	990	1,21	1	0	3.954 €
	AFD-2C-PC	1565	2160	990	2,33	2	0	5.444 €
	AFD-3C-PC	2240	2160	990	3,48	3	0	6.922 €
	AFD-4C-PC	2915	2160	990	4,57	4	0	8.695 €
	AFD-5C-PC	3590	2160	990	5,69	5	0	10.076 €

Opción:  
Alturas diferentes a la estándar: 2360 y 2560  
Espesor : 100mm

Optional:  
Alternative heights: 2360 and 2560  
Thickness: 100 mm

Estanterías NO incluidas  
Shelves NOT included



Estanterías NO incluidas en el precio del armario  
Shelves NOT included in the reach-in standard price

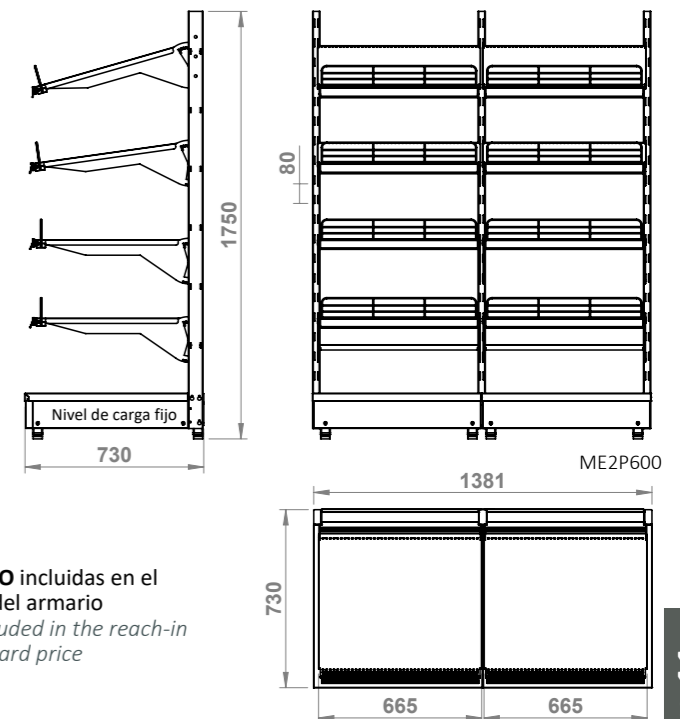



# Serie RFM-S

RECINTOS FRIGORÍFICOS MODULARES  
SIN COLUMNAS

*MODULAR COLD ROOMS  
WITHOUT COLUMNS*

## S-line





Recintos Frigoríficos Modulares, GAMA RFM-S, completa la primera gama presentada meses atrás por CORECO. Hemos desarrollado esta gama, reduciendo los elementos constructivos manteniendo la solidez y capacidad aislante del recinto. Esta nueva gama, se manufactura siguiendo los mismos principios empleados en el resto de la producción de cámaras frigoríficas, con maquinaria controlada por computadora y personal cualificado. El resultado es una recinto frigorífico con personalidad propia y adaptado a las exigencias del mercado actual.

RFM-S RANGE cold rooms, completes the first range presented months ago by CORECO. We have developed this range, reducing the construction elements while maintaining the solidity and insulating capacity of the room. This new range is manufactured following the same principles used in the rest of the production of cold rooms, with computer-controlled machinery and qualified personnel. The result is a Refrigerating Enclosure with its own personality and adapted to the demands of the current market.

Sistema de montaje SIN COLUMNAS

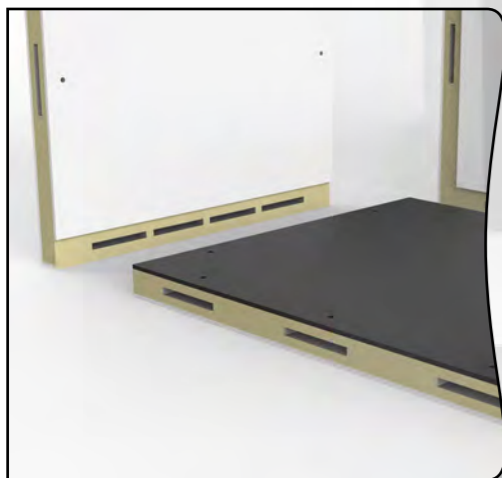

Panel to panel, easy assembly system

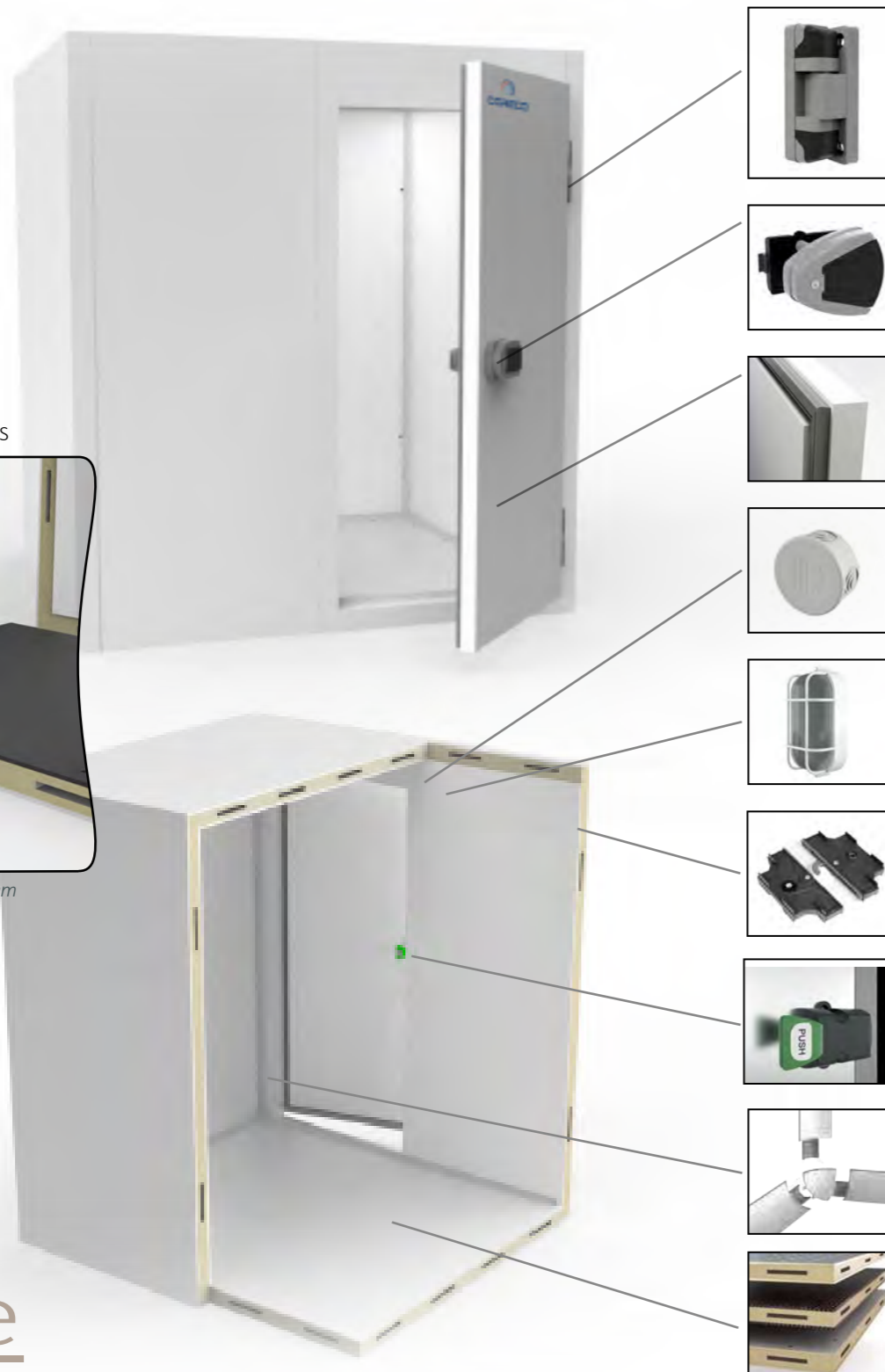

S-line

SECCIÓN Y ALTURAS. / HEIGHTS AND SECTIONS.

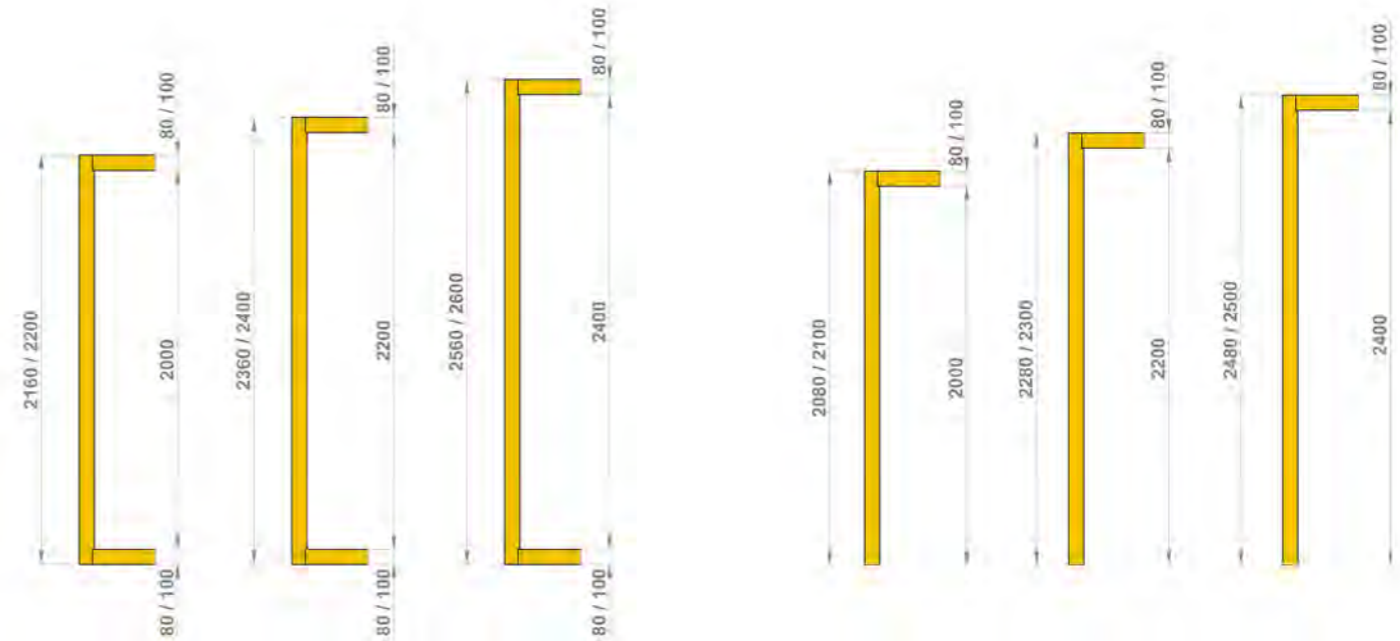

CON suelo panel  
WITH floor panel

SIN suelo panel  
WITHOUT floor panel

ESPACIOS NECESARIOS PARA UNA CORRECTA INSTALACIÓN.

Recomendamos una adecuada nivelación del suelo donde vaya a ser instalado el recinto frigorífico. Prever que el lugar de ubicación permite el acceso del panel de mayor dimensión.

SPACE NEEDED FOR CORRECT INSTALLATION.

We recommend an adequate leveling of the floor where the cold room will be installed. Ensure that the location allows access with the largest panel.

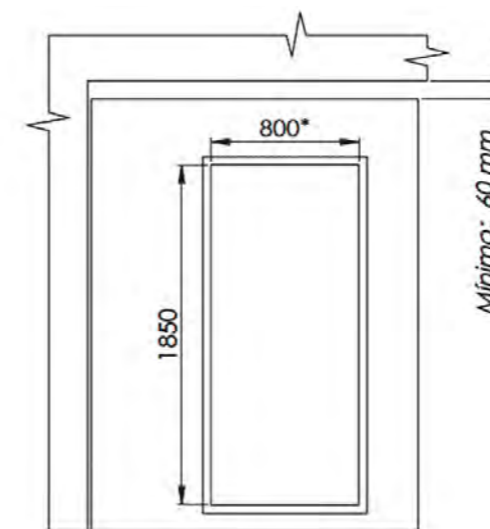

\*Bajo pedido, 600, 700, 900 y 1000  
\*On demand 600, 700, 900 and 1000

Para poder realizar un montaje correcto es necesario dejar entre el techo del local y el techo del recinto al menos el espesor del panel + 20 mm.

For correct assembly, leave at least the thickness of a panel + 20mm between the roof of the premises and the roof of the room.

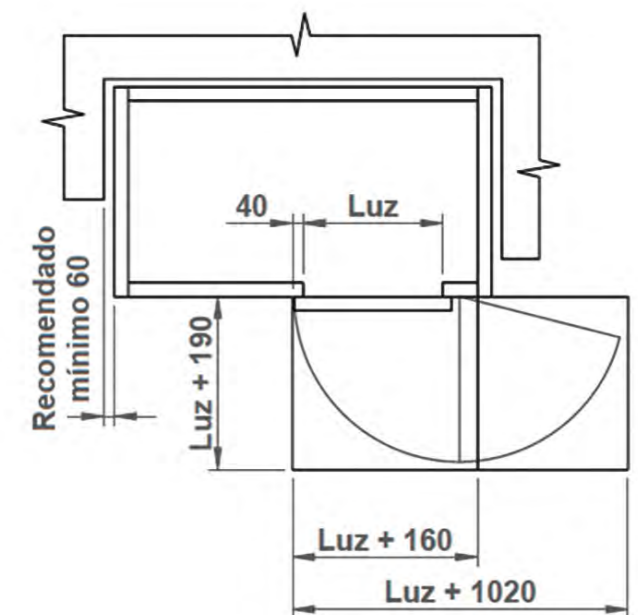

Dimensiones necesarias para una apertura de la puerta a 90° y 180°.

Measurements needed to open the door at 90° and 180°.



#### Modularidad y paneles:

- Espesor de 80 y 100 mm
- Modulación 200 mm.
- Cuatro anchos de panel: 400, 800, 1000 y 1200 mm
- Alturas exteriores panel 80: 2160, 2360 y 2560 mm
- Alturas exteriores panel 100: 2200, 2400, 2600
- Longitud máxima del panel 3120 mm (80) 3160 (100)

#### Modularity and panels:

- Thickness of 80 and 100 mm
- Modulation 200 mm.
- Four panel widths: 400, 800, 1000 and 1200 mm
- Exterior panel heights 80: 2160, 2360 and 2560 mm
- Exterior panel heights 100: 2200, 2400, 2600
- Maximum panel length 3120 mm (80) 3160 (100)



#### Aislamiento:

- Espuma rígida de poliuretano, libre de CFC e inyectado a alta presión
- Densidad 45 Kg. / m<sup>2</sup>
- Coeficiente de conductividad térmica 0.022W/mK a 10°C. (Sin envejecimiento)

#### Insulation:

- Rigid polyurethane foam, CFC-free, injected at high pressure.
- Density 45kg/m<sup>2</sup>.
- Thermal conductivity coefficient 0.022W/mK at 10°C. (Without ageing).



#### Revestimiento:

- Revestimiento estándar en acero galvanizado prelacado poliéster, con film de protección.
- Color blanco pirineo.
- Calidad alimentaria.

#### Cladding:

- Galvanized steel cladding pre-lacquered with polyester, with a protective film, as standard.
- Colour white, "blanco pirineo".
- Food grade.

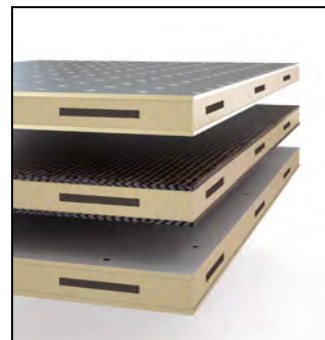

#### Terminación del Panel de Suelo:

- Suelo reforzado: Idóneo para el tránsito de personas y carretillas manuales. Acabado interior de contrachapado de abedul y resina fenólica antideslizante.
- Suelo de acero inoxidable antideslizante aisi 304 18/8.
- Suelo de chapa lacada blanca igual que el resto de paneles.

#### Floor Panel Finish:

- Reinforced flooring: Ideal for the transit of people and manual trucks. Birch plywood interior finish with non-slip phenolic resin.
- Non-slip stainless steel flooring AISI 304 18/8.
- Metal flooring lacquered white the same as the rest of the panels.



#### Perfil sanitario perimetral:

- Diseño cóncavo, dos piezas más tapones esquineros en las uniones
- Base de fijación fabricada en PVC alta resistencia y dispuesta en ángulo
- Perfil sanitario rígido en su parte central y flexible en los extremos para adaptarse al panel
- Esquinas rematadas con tapón de diseño semiesférico para dar continuidad al perímetro sanitario

#### Perimetral sanitary profile:

- Concave design, two pieces and corner plugs for the joints
- Base profile made of high resistance PVC and angled
- Rigid sanitary profile in its central part and flexible at the ends
- Finishing corners with a hemispherical design cap, let to continuity the sanitary perimetral structure

## S-line



#### Sistema de Unión:

- Vástago giratorio, encajable en alojamiento con sistema de sujeción por presión, llave incluida, fabricado en ABS de alta resistencia.

#### Panel fixings:

- Swivel stem, nestable in housing with a pressure clamping system, key included, made of high resistance ABS.

#### Puerta:

- Pivotante con apertura a mano derecha, puede colocarse en los 4 lados de la cámara
- Burlate desmontable con ajuste perimetral sobre el marco, asegura la estanqueidad
- Hueco de luz de puerta 1850 x 800 mm
- Sólo en panel 100 mm: resistencia eléctrica antiescarcha colocada en el marco del panel de puerta con caja de conexiones
- Panel puerta y la puerta, están aisladas con el mismo poliuretano empleado en el resto de paneles
- Bisagras de gran calidad y resistencia
- Cierre de un punto de presión, con llave exterior y desbloqueo interior

#### Door:

- Pivoting door with right-hand opening, can be placed on all 4 sides of the cold room
- Removable gasket with perimeter adjustment on the frame, ensures tightness
- Door passthrough 1850 x 800 mm
- Only for panel 100: electric frost resistance on the door panel frame with connections box
- Door panel and door are insulated with the same polyurethane used in the whole structure
- High quality and resistant hinges
- Locking of a pressure point, with external key and internal release

#### Accesorios incluidos:

- Válvula compensadora de presiones para todas las cámaras de espesor 100
- Perfil sanitario postizo
- Perfil "U" de montaje para cámaras sin panel de suelo
- Luz interior
- Llave hexagonal con mango para montaje de las fijaciones de paneles
- Caja de conexiones y resistencia marco sólo en puerta para panel 100

#### Parts included:

- Pressure compensation valve for all chambers of thickness 100
- Detachable sanitary profile
- Mounting "U" profile for cameras without floor panel
- Interior light
- Hexagonal wrench with handle for mounting panel fixings
- Junction box and resistance frame only in door for panel 100

#### OPCIONES bajo pedido

- Otras calidades y colores para el revestimiento del panel tanto para el exterior como en el interior
- Suelo con acabado interior en acero inoxidable antideslizante
- Suelo con acabado blanco pirineo, igual al resto de paneles
- Equipo frigorífico
- Estanterías de aluminio y polietileno de fabricación propia.
- Resistencia eléctrica en cámaras de espesor 80 mm.
- Puerta apertura a mano izquierda (estándar abre a mano derecha)
- Puerta corredera 1850 x 800 mm
- Huecos de puerta, abatible o corredera, con anchos especiales: 600, 700, 900 y 1000 mm
- Hacha de bombero
- Soporte hacha
- Alarma hombre atrapado
- Rampa para puerta abatible o corredera
- Rastreles para separación entre el panel inferior y el suelo

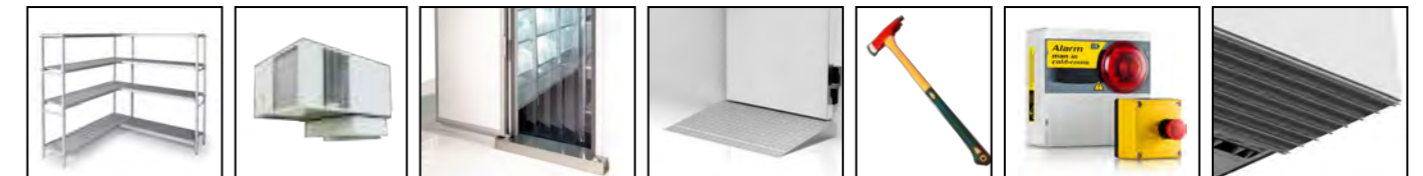

#### OPTIONS on request

- Other qualities and colors for the panel covering both for the exterior and interior
- Floor with non-slip stainless steel interior finish
- Floor with a white pyrenean finish, the same as the other panels
- Refrigeration equipment
- Self-made aluminum and polyethylene shelves.
- Electrical resistance in chambers of thickness 80 mm.
- Door open on the left (standard opens on the right)
- Sliding door 1850 x 800 mm
- Door openings, pivoting or sliding, with special widths: 600, 700, 900 and 1000 mm
- Fire ax
- Ax support
- Trapped man alarm
- Ramp for swing or sliding door
- Tracks for separation between bottom panel and base floor



En las tablas de la siguiente página, se identifica el modelo del recinto correspondiente con el espesor de aislamiento (80 / 100 mm) y las medias en planta (largo y fondo).

Este código le dirigirá a la página correspondiente, donde en base a la altura y tipo de suelo, podrá determinar código y precio del recinto.

También se identifica en la tabla particular para cada configuración, el volumen interior de la cámara, lo cual le ayudará a seleccionar el equipo frigorífico apropiado.

The tables on the following page show the corresponding room model with an insulation thickness of 80/100mm and its floor measurements (length and width).

Use the code to locate the corresponding page, where based on the height and type of floor, you can determine the code and price of the room.

For each room layout the table also gives its interior volume, to help you to select the appropriate refrigerator equipment.

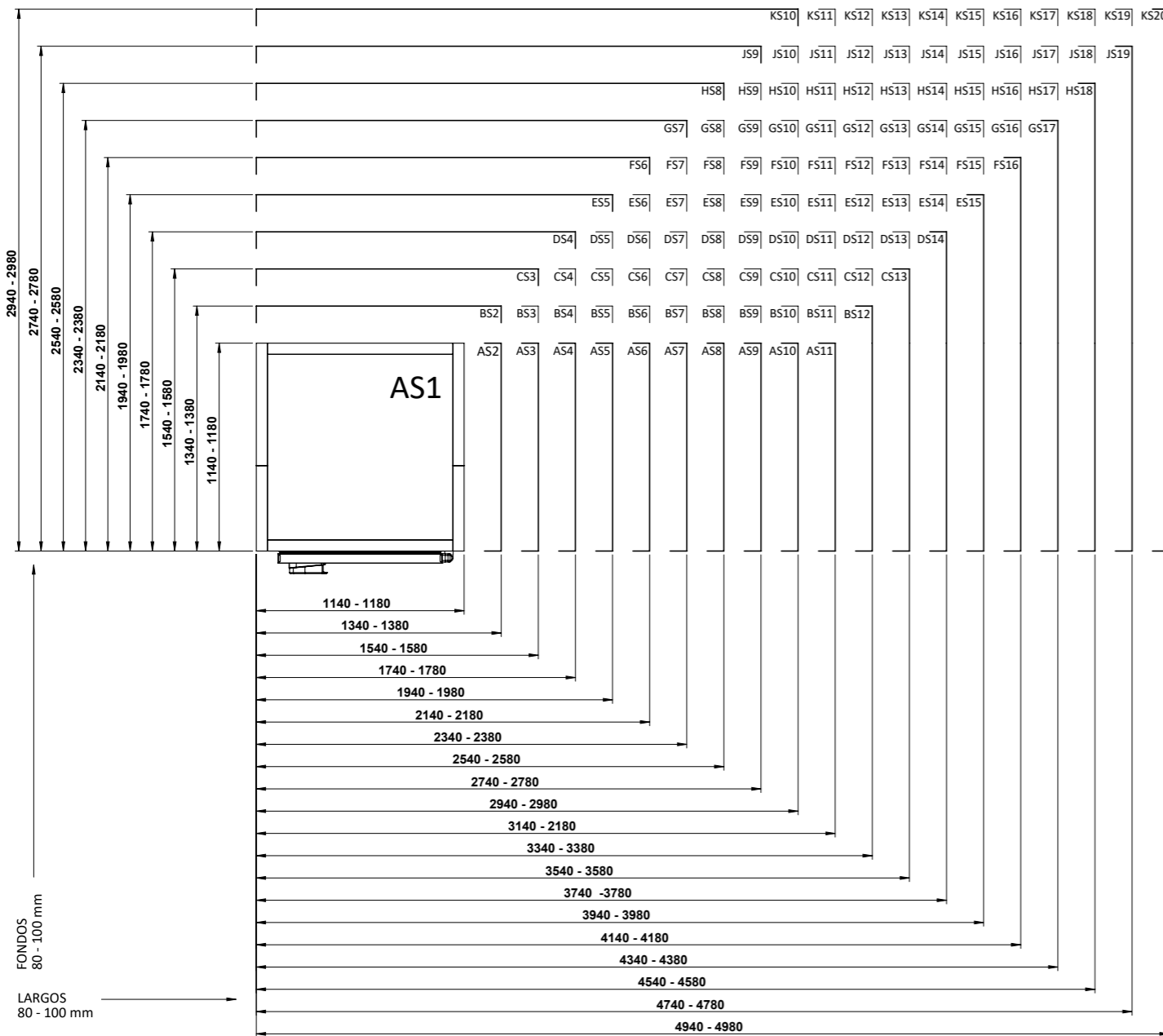

80		Largo - Length (L) mm																				
		1140	1340	1540	1740	1940	2140	2340	2540	2740	2940	3140	3340	3540	3740	3940	4140	4340	4540	4740	4940	PAG
Fondo - Depth mm	1140	AS1	AS2	AS3	AS4	AS5	AS6	AS7	AS8	AS9	AS10	AS11										
	1340		BS2	BS3	BS4	BS5	BS6	BS7	BS8	BS9	BS10	BS11	BS12									
	1540			CS3	CS4	CS5	CS6	CS7	CS8	CS9	CS10	CS11	CS12	CS13								
	1740				DS4	DS5	DS6	DS7	DS8	DS9	DS10	DS11	DS12	DS13	DS14							
	1940					ES5	ES6	ES7	ES8	ES9	ES10	ES11	ES12	ES13	ES14	ES15						
	2140						FS6	FS7	FS8	FS9	FS10	FS11	FS12	FS13	FS14	FS15	FS16					
	2340								GS7	GS8	GS9	GS10	GS11	GS12	GS13	GS14	GS15	GS16	GS17			
	2540									HS8	HS9	HS10	HS11	HS12	HS13	HS14	HS15	HS16	HS17	HS18		
	2740										JS9	JS10	JS11	JS12	JS13	JS14	JS15	JS16	JS17	JS18	JS19	
	2940											KS10	KS11	KS12	KS13	KS14	KS15	KS16	KS17	KS18	KS19	KS20

100		Largo - Length (L) mm																				
		1180	1380	1580	1780	1980	2180	2380	2580	2780	2980	3180	3380	3580	3780	3980	4180	4380	4580	4780	4980	PAG
Fondo - Depth mm	1180	AS1	AS2	AS3	AS4	AS5	AS6	AS7	AS8	AS9	AS10	AS11										
	1380		BS2	BS3	BS4	BS5	BS6	BS7	BS8	BS9	BS10	BS11	BS12									
	1580			CS3	CS4	CS5	CS6	CS7	CS8	CS9	CS10	CS11	CS12	CS13								
	1780				DS4	DS5	DS6	DS7	DS8	DS9	DS10	DS11	DS12	DS13	DS14							
	1980					ES5	ES6	ES7	ES8	ES9	ES10	ES11	ES12	ES13	ES14	ES15						
	2180						FS6	FS7	FS8	FS9	FS10	FS11	FS12	FS13	FS14	FS15	FS16					
	2380							GS7	GS8	GS9	GS10	GS11	GS12	GS13	GS14	GS15	GS16	GS17				
	2580								HS8	HS9	HS10	HS11	HS12	HS13	HS14	HS15	HS16	HS17	HS18			
	2780									JS9	JS10	JS11	JS12	JS13	JS14	JS15	JS16	JS17	JS18	JS19		
	2980										KS10	KS11	KS12	KS13	KS14	KS15	KS16	KS17	KS18	KS19	KS20	

A la hora de elegir su cámara, tenga en cuenta que la ubicación de la puerta estará siempre colocada en el largo.  
At time of choosing your Cold Room, keep in mind that the location of the door will always be placed on the length part of the Cold Room.

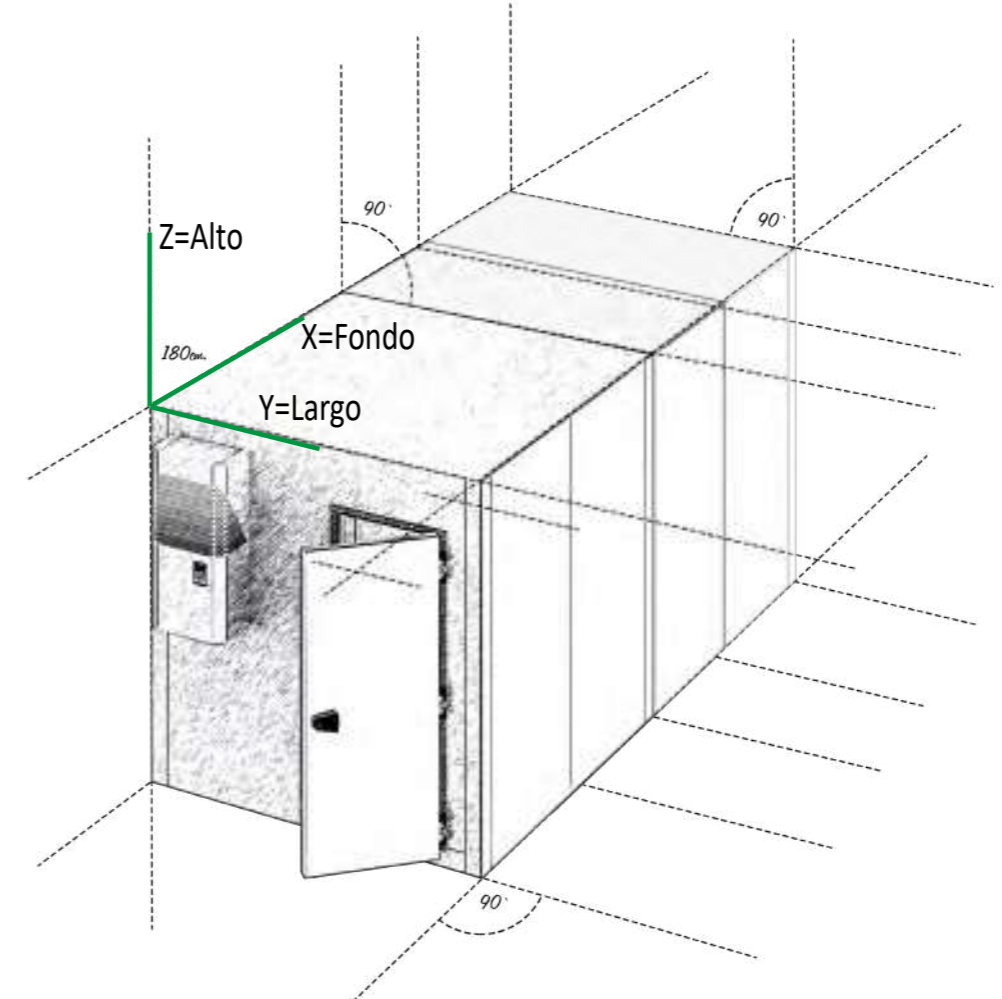



<b>80</b>	Largo - Length (L)																			
	1140	1340	1540	1740	1940	2140	2340	2540	2740	2940	3140	3340	3540	3740	3940	4140	4340	4540	4740	4940
Fondo - Depth mm	1140	AS1	AS2	AS3	AS4	AS5	AS6	AS7	AS8	AS9	AS10	AS11								

<b>80</b>	CON suelo - WITH floor panel					SIN suelo - WITHOUT floor panel				
	COD	m <sup>3</sup>	L	H	€	COD	m <sup>3</sup>	L	H	€
<b>AS1</b>	AS1R-114114AC	1,92	1140	2160	<b>2.168 €</b>	AS1R-114114AS	1,92	1140	2080	<b>1.947 €</b>
	AS1R-114114BC	2,11	1140	2360	<b>2.278 €</b>	AS1R-114114BS	2,11	1140	2280	<b>2.057 €</b>
	AS1R-114114CC	2,30	1140	2560	<b>2.392 €</b>	AS1R-114114CS	2,30	1140	2480	<b>2.174 €</b>
<b>AS2</b>	AS2R-114134AC	2,31	1340	2160	<b>2.340 €</b>	AS2R-114134AS	2,31	1340	2080	<b>2.077 €</b>
	AS2R-114134BC	2,54	1340	2360	<b>2.464 €</b>	AS2R-114134BS	2,54	1340	2280	<b>2.199 €</b>
	AS2R-114134CC	2,78	1340	2560	<b>2.584 €</b>	AS2R-114134CS	2,78	1340	2480	<b>2.324 €</b>
<b>AS3</b>	AS3R-114154AC	2,70	1540	2160	<b>2.514 €</b>	AS3R-114154AS	2,70	1540	2080	<b>2.210 €</b>
	AS3R-114154BC	2,98	1540	2360	<b>2.648 €</b>	AS3R-114154BS	2,98	1540	2280	<b>2.343 €</b>
	AS3R-114154CC	3,25	1540	2560	<b>2.776 €</b>	AS3R-114154CS	3,25	1540	2480	<b>2.476 €</b>
<b>AS4</b>	AS4R-114174AC	3,10	1740	2160	<b>2.686 €</b>	AS4R-114174AS	3,10	1740	2080	<b>2.339 €</b>
	AS4R-114174BC	3,41	1740	2360	<b>2.831 €</b>	AS4R-114174BS	3,41	1740	2280	<b>2.481 €</b>
	AS4R-114174CC	3,72	1740	2560	<b>2.971 €</b>	AS4R-114174CS	3,72	1740	2480	<b>2.626 €</b>
<b>AS5</b>	AS5R-114194AC	3,49	1940	2160	<b>2.858 €</b>	AS5R-114194AS	3,49	1940	2080	<b>2.468 €</b>
	AS5R-114194BC	3,84	1940	2360	<b>3.009 €</b>	AS5R-114194BS	3,84	1940	2280	<b>2.623 €</b>
	AS5R-114194CC	4,19	1940	2560	<b>3.162 €</b>	AS5R-114194CS	4,19	1940	2480	<b>2.774 €</b>
<b>AS6</b>	AS6R-114214AC	3,88	2140	2160	<b>3.033 €</b>	AS6R-114214AS	3,88	2140	2080	<b>2.600 €</b>
	AS6R-114214BC	4,27	2140	2360	<b>3.197 €</b>	AS6R-114214BS	4,27	2140	2280	<b>2.763 €</b>
	AS6R-114214CC	4,66	2140	2560	<b>3.355 €</b>	AS6R-114214CS	4,66	2140	2480	<b>2.928 €</b>
<b>AS7</b>	AS7R-114234AC	4,27	2340	2160	<b>3.206 €</b>	AS7R-114234AS	4,27	2340	2080	<b>2.730 €</b>
	AS7R-114234BC	4,70	2340	2360	<b>3.374 €</b>	AS7R-114234BS	4,70	2340	2280	<b>2.903 €</b>
	AS7R-114234CC	5,13	2340	2560	<b>3.547 €</b>	AS7R-114234CS	5,13	2340	2480	<b>3.076 €</b>
<b>AS8</b>	AS8R-114254AC	4,66	2540	2160	<b>3.375 €</b>	AS8R-114254AS	4,66	2540	2080	<b>2.864 €</b>
	AS8R-114254BC	5,13	2540	2360	<b>3.557 €</b>	AS8R-114254BS	5,13	2540	2280	<b>3.043 €</b>
	AS8R-114254CC	5,60	2540	2560	<b>3.737 €</b>	AS8R-114254CS	5,60	2540	2480	<b>3.230 €</b>
<b>AS9</b>	AS9R-114274AC	5,06	2740	2160	<b>3.551 €</b>	AS9R-114274AS	5,06	2740	2080	<b>2.995 €</b>
	AS9R-114274BC	5,56	2740	2360	<b>3.741 €</b>	AS9R-114274BS	5,56	2740	2280	<b>3.186 €</b>
	AS9R-114274CC	6,07	2740	2560	<b>3.935 €</b>	AS9R-114274CS	6,07	2740	2480	<b>3.378 €</b>
<b>AS10</b>	AS10R-114294AC	5,45	2940	2160	<b>3.722 €</b>	AS10R-114294AS	5,45	2940	2080	<b>3.123 €</b>
	AS10R-114294BC	5,99	2940	2360	<b>3.920 €</b>	AS10R-114294BS	5,99	2940	2280	<b>3.325 €</b>
	AS10R-114294CC	6,54	2940	2560	<b>4.127 €</b>	AS10R-114294CS	6,54	2940	2480	<b>3.531 €</b>
<b>AS11</b>	AS11R-114314AC	5,84	3140	2160	<b>3.896 €</b>	AS11R-114314AS	5,84	3140	2080	<b>3.256 €</b>
	AS11R-114314BC	6,42	3140	2360	<b>4.109 €</b>	AS11R-114314BS	6,42	3140	2280	<b>3.472 €</b>
	AS11R-114314CC	7,01	3140	2560	<b>4.319 €</b>	AS11R-114314CS	7,01	3140	2480	<b>3.678 €</b>

<b>100</b>	Largo - Length (L)																			
	1180	1380	1580	1780	1980	2180	2380	2580	2780	2980	3180	3380	3580	3780	3980	4180	4380	4580	4780	4980
Fondo - Depth mm	1180	AS1	AS2	AS3	AS4	AS5	AS6	AS7	AS8	AS9	AS10	AS11								

<b>100</b>	CON suelo - WITH floor panel					SIN suelo - WITHOUT floor panel				
	COD	m <sup>3</sup>	L	H	€	COD	m <sup>3</sup>	L	H	€
<b>AS1</b>	AS1C-118118AC	1,92	1180	2200	<b>2.440 €</b>	AS1C-118118AS	1,92	1180	2100	<b>2.191 €</b>
	AS1C-118118BC	2,11	1180	2400	<b>2.566 €</b>	AS1C-118118BS	2,11	1180	2300	<b>2.317 €</b>
	AS1C-118118CC	2,30	1180	2600	<b>2.691 €</b>	AS1C-118118CS	2,30	1180	2500	<b>2.442 €</b>
<b>AS2</b>	AS2C-118138AC	2,31	1380	2200	<b>2.627 €</b>	AS2C-118138AS	2,31	1380	2100	<b>2.339 €</b>
	AS2C-118138BC	2,54	1380	2400	<b>2.764 €</b>	AS2C-118138BS	2,54	1380	2300	<b>2.474 €</b>
	AS2C-118138CC	2,78	1380	2600	<b>2.897 €</b>	AS2C-118138CS	2,78	1380	2500	<b>2.606 €</b>
<b>AS3</b>	AS3C-118158AC	2,70	1580	2200	<b>2.819 €</b>	AS3C-118158AS	2,70	1580	2100	<b>2.478 €</b>
	AS3C-118158BC	2,98	1580	2400	<b>2.961 €</b>	AS3C-118158BS	2,98	1580	2300	<b>2.623 €</b>
	AS3C-118158CC	3,25	1580	2600	<b>3.104 €</b>	AS3C-118158CS	3,25	1580	2500	<b>2.769 €</b>
<b>AS4</b>	AS4C-118178AC	3,10	1780	2200	<b>3.003 €</b>	AS4C-118178AS	3,10	1780	2100	<b>2.619 €</b>
	AS4C-118178BC	3,41	1780	2400	<b>3.160 €</b>	AS4C-118178BS	3,41	1780	2300	<b>2.780 €</b>
	AS4C-118178CC	3,72	1780	2600	<b>3.319 €</b>	AS4C-118178CS	3,72	1780	2500	<b>2.933 €</b>
<b>AS5</b>	AS5C-118198AC	3,49	1980	2200	<b>3.189 €</b>	AS5C-118198AS	3,49	1980	2100	<b>2.761 €</b>
	AS5C-118198BC	3,84	1980	2400	<b>3.362 €</b>	AS5C-118198BS	3,84	1980	2300	<b>2.932 €</b>
	AS5C-118198CC	4,19	1980	2600	<b>3.526 €</b>	AS5C-118198CS	4,19	1980	2500	<b>3.097 €</b>
<b>AS6</b>	AS6C-118218AC	3,88	2180	2200	<b>3.383 €</b>	AS6C-118218AS	3,88	2180	2100	<b>2.908 €</b>
	AS6C-118218BC	4,27	2180	2400	<b>3.561 €</b>	AS6C-118218BS	4,27	2180	2300	<b>3.081 €</b>
	AS6C-118218CC	4,66	2180	2600	<b>3.736 €</b>	AS6C-118218CS	4,66	2180	2500	<b>3.260 €</b>
<b>AS7</b>	AS7C-118238AC	4,27	2380	2200	<b>3.568 €</b>	AS7C-118238AS	4,27	2380	2100	<b>3.049 €</b>
	AS7C-118238BC	4,70	2380	2400	<b>3.755 €</b>	AS7C-118238BS	4,70	2380	2300	<b>3.237 €</b>
	AS7C-118238CC	5,13	2380	2600	<b>3.946 €</b>	AS7C-118238CS	5,13	2380	2500	<b>3.429 €</b>
<b>AS8</b>	AS8C-118258AC	4,66	2580	2200	<b>3.756 €</b>	AS8C-118258AS	4,66	2580	2100	<b>3.192 €</b>
	AS8C-118258BC	5,13	2580	2400	<b>3.956 €</b>	AS8C-118258BS	5,13	2580	2300	<b>3.390 €</b>
	AS8C-118258CC	5,60	2580	2600	<b>4.151 €</b>	AS8C-118258CS	5,60	2580	2500	<b>3.592 €</b>
<b>AS9</b>	AS9C-118278AC	5,06	2780	2200	<b>3.941 €</b>	AS9C-118278AS	5,06	2780	2100	<b>3.336 €</b>
	AS9C-118278BC	5,56	2780	2400	<b>4.158 €</b>	AS9C-118278BS	5,56	2780	2300	<b>3.549 €</b>
	AS9C-118278CC	6,07	2780	2600	<b>4.362 €</b>	AS9C-118278CS	6,07	2780	2500	<b>3.752 €</b>
<b>AS10</b>	AS10C-118298AC	5,45	2980	2200	<b>4.133 €</b>	AS10C-118298AS	5,45	2980	2100	<b>3.474 €</b>
	AS10C-118298BC	5,99	2980	2400	<b>4.351 €</b>	AS10C-118298BS	5,99	2980	2300	<b>3.694 €</b>
	AS10C-118298CC	6,54	2980	2600	<b>4.580 €</b>	AS10C-118298CS	6,54	2980	2500	<b>3.918 €</b>
<b>AS11</b>	AS11C-118318AC	5,84	3180	2200	<b>4.320 €</b>	AS11C-118318AS	5,84	3180	2100	<b>3.622 €</b>
	AS11C-118318BC	6,42	3180	2400	<b>4.553 €</b>	AS11C-118318BS	6,42	3180	2300	<b>3.850 €</b>
	AS11C-118318CC	7,01	3180	2600	<b>4.786 €</b>	AS11C-118318CS	7,01	3180	2500	<b>4.080 €</b>



80	Largo - Length (L)																			
	1140	1340	1540	1740	1940	2140	2340	2540	2740	2940	3140	3340	3540	3740	3940	4140	4340	4540	4740	4940
Fondo - Depth mm	1340	BS2	BS3	BS4	BS5	BS6	BS7	BS8	BS9	BS10	BS11	BS12								

80	CON suelo - WITH floor panel					SIN suelo - WITHOUT floor panel				
	COD	m²	L	H	€	COD	m²	L	H	€
BS2	BS2R-134134AC	2,78	1340	2160	2.524 €	BS2R-134134AS	2,78	1340	2080	2.213 €
	BS2R-134134BC	3,06	1340	2360	2.659 €	BS2R-134134BS	3,06	1340	2280	2.345 €
	BS2R-134134CC	3,34	1340	2560	2.790 €	BS2R-134134CS	3,34	1340	2480	2.482 €
BS3	BS3R-134154AC	3,26	1540	2160	2.711 €	BS3R-134154AS	3,26	1540	2080	2.349 €
	BS3R-134154BC	3,58	1540	2360	2.853 €	BS3R-134154BS	3,58	1540	2280	2.494 €
	BS3R-134154CC	3,91	1540	2560	2.995 €	BS3R-134154CS	3,91	1540	2480	2.634 €
BS4	BS4R-134174AC	3,73	1740	2160	2.896 €	BS4R-134174AS	3,73	1740	2080	2.487 €
	BS4R-134174BC	4,1	1740	2360	3.051 €	BS4R-134174BS	4,1	1740	2280	2.639 €
	BS4R-134174CC	4,47	1740	2560	3.204 €	BS4R-134174CS	4,47	1740	2480	2.791 €
BS5	BS5R-134194AC	4,2	1940	2160	3.081 €	BS5R-134194AS	4,2	1940	2080	2.620 €
	BS5R-134194BC	4,62	1940	2360	3.247 €	BS5R-134194BS	4,62	1940	2280	2.786 €
	BS5R-134194CC	5,04	1940	2560	3.409 €	BS5R-134194CS	5,04	1940	2480	2.947 €
BS6	BS6R-134214AC	4,67	2140	2160	3.266 €	BS6R-134214AS	4,67	2140	2080	2.755 €
	BS6R-134214BC	5,14	2140	2360	3.443 €	BS6R-134214BS	5,14	2140	2280	2.930 €
	BS6R-134214CC	5,61	2140	2560	3.610 €	BS6R-134214CS	5,61	2140	2480	3.103 €
BS7	BS7R-134234AC	5,14	2340	2160	3.455 €	BS7R-134234AS	5,14	2340	2080	2.892 €
	BS7R-134234BC	5,66	2340	2360	3.636 €	BS7R-134234BS	5,66	2340	2280	3.073 €
	BS7R-134234CC	6,17	2340	2560	3.821 €	BS7R-134234CS	6,17	2340	2480	3.258 €
BS8	BS8R-134254AC	5,62	2540	2160	3.643 €	BS8R-134254AS	5,62	2540	2080	3.028 €
	BS8R-134254BC	6,18	2540	2360	3.830 €	BS8R-134254BS	6,18	2540	2280	3.219 €
	BS8R-134254CC	6,74	2540	2560	4.027 €	BS8R-134254CS	6,74	2540	2480	3.413 €
BS9	BS9R-134274AC	6,09	2740	2160	3.825 €	BS9R-134274AS	6,09	2740	2080	3.163 €
	BS9R-134274BC	6,7	2740	2360	4.029 €	BS9R-134274BS	6,7	2740	2280	3.364 €
	BS9R-134274CC	7,31	2740	2560	4.230 €	BS9R-134274CS	7,31	2740	2480	3.567 €
BS10	BS10R-134294AC	6,56	2940	2160	4.009 €	BS10R-134294AS	6,56	2940	2080	3.299 €
	BS10R-134294BC	7,22	2940	2360	4.218 €	BS10R-134294BS	7,22	2940	2280	3.516 €
	BS10R-134294CC	7,87	2940	2560	4.428 €	BS10R-134294CS	7,87	2940	2480	3.725 €
BS11	BS11R-134314AC	7,03	3140	2160	4.192 €	BS11R-134314AS	7,03	3140	2080	3.440 €
	BS11R-134314BC	7,74	3140	2360	4.419 €	BS11R-134314BS	7,74	3140	2280	3.655 €
	BS11R-134314CC	8,44	3140	2560	4.643 €	BS11R-134314CS	8,44	3140	2480	3.881 €
BS12	BS12R-134334AC	7,5	3340	2160	4.379 €	BS12R-134334AS	7,5	3340	2080	3.573 €
	BS12R-134334BC	8,26	3340	2360	4.614 €	BS12R-134334BS	8,26	3340	2280	3.802 €
	BS12R-134334CC	9,01	3340	2560	4.838 €	BS12R-134334CS	9,01	3340	2480	4.033 €

100	Largo - Length (L)																			
	1180	1380	1580	1780	1980	2180	2380	2580	2780	2980	3180	3380	3580	3780	3980	4180	4380	4580	4780	4980
Fondo - Depth mm	1380	BS2	BS3	BS4	BS5	BS6	BS7	BS8	BS9	BS10	BS11	BS12								

100	CON suelo - WITH floor panel					SIN suelo - WITHOUT floor panel				
	COD	m²	L	H	€	COD	m²	L	H	€
BS2	BS2C-138138AC	2,78	1380	2200	2.832 €	BS2C-138138AS	2,78	1380	2100	2.481 €
	BS2C-138138BC	3,06	1380	2400	2.974 €	BS2C-138138BS	3,06	1380	2300	2.627 €
	BS2C-138138CC	3,34	1380	2600	3.121 €	BS2C-138138CS	3,34	1380	2500	2.775 €
BS3	BS3C-138158AC	3,26	1580	2200	3.031 €	BS3C-138158AS	3,26	1580	2100	2.630 €
	BS3C-138158BC	3,58	1580	2400	3.188 €	BS3C-138158BS	3,58	1580	2300	2.791 €
	BS3C-138158CC	3,91	1580	2600	3.345 €	BS3C-138158CS	3,91	1580	2500	2.945 €
BS4	BS4C-138178AC	3,73	1780	2200	3.232 €	BS4C-138178AS	3,73	1780	2100	2.778 €
	BS4C-138178BC	4,10	1780	2400	3.396 €	BS4C-138178BS	4,1	1780	2300	2.945 €
	BS4C-138178CC	4,47	1780	2600	3.570 €	BS4C-138178CS	4,47	1780	2500	3.115 €
BS5	BS5C-138198AC	4,20	1980	2200	3.438 €	BS5C-138198AS	4,2	1980	2100	2.926 €
	BS5C-138198BC	4,62	1980	2400	3.610 €	BS5C-138198BS	4,62	1980	2300	3.104 €
	BS5C-138198CC	5,04	1980	2600	3.791 €	BS5C-138198CS	5,04	1980	2500	3.282 €
BS6	BS6C-138218AC	4,67	2180	2200	3.638 €	BS6C-138218AS	4,67	2180	2100	3.076 €
	BS6C-138218BC	5,14	2180	2400	3.825 €	BS6C-138218BS	5,14	2180	2300	3.268 €
	BS6C-138218CC	5,61	2180	2600	4.014 €	BS6C-138218CS	5,61	2180	2500	3.456 €
BS7	BS7C-138238AC	5,14	2380	2200	3.836 €	BS7C-138238AS	5,14	2380	2100	3.225 €
	BS7C-138238BC	5,66	2380	2400	4.038 €	BS7C-138238BS	5,66	2380	2300	3.420 €
	BS7C-138238CC	6,17	2380	2600	4.238 €	BS7C-138238CS	6,17	2380	2500	3.621 €
BS8	BS8C-138258AC	5,62	2580	2200	4.038 €	BS8C-138258AS	5,62	2580	2100	3.374 €
	BS8C-138258BC	6,18	2580	2400	4.254 €	BS8C-138258BS	6,18	2580	2300	3.583 €
	BS8C-138258CC	6,74	2580	2600	4.462 €	BS8C-138258CS	6,74	2580	2500	3.796 €
BS9	BS9C-138278AC	6,09	2780	2200	4.245 €	BS9C-138278AS	6,09	2780	2100	3.517 €
	BS9C-138278BC	6,70	2780	2400	4.465 €	BS9C-138278BS	6,7	2780	2300	3.739 €
	BS9C-138278CC	7,31	2780	2600	4.681 €	BS9C-138278CS	7,31	2780	2500	3.965 €
BS10	BS10C-138298AC	6,56	2980	2200	4.444 €	BS10C-138298AS	6,56	2980	2100	3.667 €
	BS10C-138298BC	7,22	2980	2400	4.680 €	BS10C-138298BS	7,22	2980	2300	3.899 €
	BS10C-138298CC	7,87	2980	2600	4.912 €	BS10C-138298CS	7,87	2980	2500	4.131 €
BS11	BS11C-138318AC	7,03	3180	2200	4.650 €	BS11C-138318AS	7,03	3180	2100	3.814 €
	BS11C-138318BC	7,74	3180	2400	4.892 €	BS11C-138318BS	7,74	3180	2300	4.056 €
	BS11C-138318CC	8,44	3180	2600	5.125 €	BS11C-138318CS	8,44	3180	2500	4.301 €
BS12	BS12C-138338AC	7,50	3380	2200	4.852 €	BS12C-138338AS	7,5	3380	2100	3.965 €
	BS12C-138338BC	8,26	3380	2400	5.099 €	BS12C-138338BS	8,26	3380	2300	4.216 €
	BS12C-138338CC	9,01	3380	2600	5.353 €	BS12C-138338CS	9,01	3380	2500	4.472 €

80	Largo - Length (L)																			
	1140	1340	1540	1740	1940	2140	2340	2540	2740	2940	3140	3340	3540	3740	3940	4140	4340	4540	4740	4940
Fondo - Depth mm 1540			CS3	CS4	CS5	CS6	CS7	CS8	CS9	CS10	CS11	CS12	CS13							

80	CON suelo - WITH floor panel					SIN suelo - WITHOUT floor panel				
	COD	m <sup>2</sup>	L	H	€	COD	m <sup>2</sup>	L	H	€
<b>CS3</b>	CS3R-154154AC	3,81	1540	2160	<b>2.909 €</b>	CS3R-154154AS	3,81	1540	2080	<b>2.491 €</b>
	CS3R-154154BC	4,19	1540	2360	<b>3.059 €</b>	CS3R-154154BS	4,19	1540	2280	<b>2.643 €</b>
	CS3R-154154CC	4,57	1540	2560	<b>3.215 €</b>	CS3R-154154CS	4,57	1540	2480	<b>2.795 €</b>
<b>CS4</b>	CS4R-154174AC	4,36	1740	2160	<b>3.109 €</b>	CS4R-154174AS	4,36	1740	2080	<b>2.632 €</b>
	CS4R-154174BC	4,8	1740	2360	<b>3.272 €</b>	CS4R-154174BS	4,8	1740	2280	<b>2.792 €</b>
	CS4R-154174CC	5,23	1740	2560	<b>3.428 €</b>	CS4R-154174CS	5,23	1740	2480	<b>2.955 €</b>
<b>CS5</b>	CS5R-154194AC	4,91	1940	2160	<b>3.304 €</b>	CS5R-154194AS	4,91	1940	2080	<b>2.771 €</b>
	CS5R-154194BC	5,4	1940	2360	<b>3.479 €</b>	CS5R-154194BS	5,4	1940	2280	<b>2.944 €</b>
	CS5R-154194CC	5,9	1940	2560	<b>3.652 €</b>	CS5R-154194CS	5,9	1940	2480	<b>3.120 €</b>
<b>CS6</b>	CS6R-154214AC	5,46	2140	2160	<b>3.507 €</b>	CS6R-154214AS	5,46	2140	2080	<b>2.910 €</b>
	CS6R-154214BC	6,01	2140	2360	<b>3.689 €</b>	CS6R-154214BS	6,01	2140	2280	<b>3.094 €</b>
	CS6R-154214CC	6,56	2140	2560	<b>3.867 €</b>	CS6R-154214CS	6,56	2140	2480	<b>3.278 €</b>
<b>CS7</b>	CS7R-154234AC	6,02	2340	2160	<b>3.698 €</b>	CS7R-154234AS	6,02	2340	2080	<b>3.054 €</b>
	CS7R-154234BC	6,62	2340	2360	<b>3.896 €</b>	CS7R-154234BS	6,62	2340	2280	<b>3.247 €</b>
	CS7R-154234CC	7,22	2340	2560	<b>4.087 €</b>	CS7R-154234CS	7,22	2340	2480	<b>3.436 €</b>
<b>CS8</b>	CS8R-154254AC	6,57	2540	2160	<b>3.902 €</b>	CS8R-154254AS	6,57	2540	2080	<b>3.198 €</b>
	CS8R-154254BC	7,23	2540	2360	<b>4.100 €</b>	CS8R-154254BS	7,23	2540	2280	<b>3.396 €</b>
	CS8R-154254CC	7,88	2540	2560	<b>4.304 €</b>	CS8R-154254CS	7,88	2540	2480	<b>3.599 €</b>
<b>CS9</b>	CS9R-154274AC	7,12	2740	2160	<b>4.098 €</b>	CS9R-154274AS	7,12	2740	2080	<b>3.335 €</b>
	CS9R-154274BC	7,83	2740	2360	<b>4.308 €</b>	CS9R-154274BS	7,83	2740	2280	<b>3.546 €</b>
	CS9R-154274CC	8,54	2740	2560	<b>4.525 €</b>	CS9R-154274CS	8,54	2740	2480	<b>3.756 €</b>
<b>CS10</b>	CS10R-154294AC	7,67	2940	2160	<b>4.293 €</b>	CS10R-154294AS	7,67	2940	2080	<b>3.479 €</b>
	CS10R-154294BC	8,44	2940	2360	<b>4.515 €</b>	CS10R-154294BS	8,44	2940	2280	<b>3.700 €</b>
	CS10R-154294CC	9,21	2940	2560	<b>4.735 €</b>	CS10R-154294CS	9,21	2940	2480	<b>3.917 €</b>
<b>CS11</b>	CS11R-154314AC	8,22	3140	2160	<b>4.493 €</b>	CS11R-154314AS	8,22	3140	2080	<b>3.620 €</b>
	CS11R-154314BC	9,05	3140	2360	<b>4.725 €</b>	CS11R-154314BS	9,05	3140	2280	<b>3.849 €</b>
	CS11R-154314CC	9,87	3140	2560	<b>4.959 €</b>	CS11R-154314CS	9,87	3140	2480	<b>4.077 €</b>
<b>CS12</b>	CS12R-154334AC	8,78	3340	2160	<b>4.692 €</b>	CS12R-154334AS	8,78	3340	2080	<b>3.760 €</b>
	CS12R-154334BC	9,65	3340	2360	<b>4.936 €</b>	CS12R-154334BS	9,65	3340	2280	<b>4.000 €</b>
	CS12R-154334CC	10,53	3340	2560	<b>5.175 €</b>	CS12R-154334CS	10,53	3340	2480	<b>4.244 €</b>
<b>CS13</b>	CS13R-154354AC	9,33	3540	2160	<b>4.890 €</b>	CS13R-154354AS	9,33	3540	2080	<b>3.896 €</b>
	CS13R-154354BC	10,26	3540	2360	<b>5.145 €</b>	CS13R-154354BS	10,26	3540	2280	<b>4.152 €</b>
	CS13R-154354CC	11,19	3540	2560	<b>5.399 €</b>	CS13R-154354CS	11,19	3540	2480	<b>4.400 €</b>

100	Largo - Length (L)																			
	1180	1380	1580	1780	1980	2180	2380	2580	2780	2980	3180	3380	3580	3780	3980	4180	4380	4580	4780	4980
Fondo - Depth mm 1580			CS3	CS4	CS5	CS6	CS7	CS8	CS9	CS10	CS11	CS12	CS13							

100	CON suelo - WITH floor panel					SIN suelo - WITHOUT floor panel				
	COD	m <sup>2</sup>	L	H	€	COD	m <sup>2</sup>	L	H	€
<b>CS3</b>	CS3C-158158AC	3,81	1580	2200	<b>3.244 €</b>	CS3C-158158AS	3,81	1580	2100	<b>2.783 €</b>
	CS3C-158158BC	4,19	1580	2400	<b>3.412 €</b>	CS3C-158158BS	4,19	1580	2300	<b>2.952 €</b>
	CS3C-158158CC	4,57	1580	2600	<b>3.583 €</b>	CS3C-158158CS	4,57	1580	2500	<b>3.122 €</b>
<b>CS4</b>	CS4C-158178AC	4,36	1780	2200	<b>3.460 €</b>	CS4C-158178AS	4,36	1780	2100	<b>2.941 €</b>
	CS4C-158178BC	4,80	1780	2400	<b>3.638 €</b>	CS4C-158178BS	4,80	1780	2300	<b>3.117 €</b>
	CS4C-158178CC	5,23	1780	2600	<b>3.822 €</b>	CS4C-158178CS	5,23	1780	2500	<b>3.293 €</b>
<b>CS5</b>	CS5C-158198AC	4,91	1980	2200	<b>3.678 €</b>	CS5C-158198AS	4,91	1980	2100	<b>3.093 €</b>
	CS5C-158198BC	5,40	1980	2400	<b>3.865 €</b>	CS5C-158198BS	5,40	1980	2300	<b>3.284 €</b>
	CS5C-158198CC	5,90	1980	2600	<b>4.057 €</b>	CS5C-158198CS	5,90	1980	2500	<b>3.470 €</b>
<b>CS6</b>	CS6C-158218AC	5,46	2180	2200	<b>3.889 €</b>	CS6C-158218AS	5,46	2180	2100	<b>3.245 €</b>
	CS6C-158218BC	6,01	2180	2400	<b>4.095 €</b>	CS6C-158218BS	6,01	2180	2300	<b>3.448 €</b>
	CS6C-158218CC	6,56	2180	2600	<b>4.295 €</b>	CS6C-158218CS	6,56	2180	2500	<b>3.648 €</b>
<b>CS7</b>	CS7C-158238AC	6,02	2380	2200	<b>4.107 €</b>	CS7C-158238AS	6,02	2380	2100	<b>3.394 €</b>
	CS7C-158238BC	6,62	2380	2400	<b>4.317 €</b>	CS7C-158238BS	6,62	2380	2300	<b>3.608 €</b>
	CS7C-158238CC	7,22	2380	2600	<b>4.529 €</b>	CS7C-158238CS	7,22	2380	2500	<b>3.818 €</b>
<b>CS8</b>	CS8C-158258AC	6,57	2580	2200	<b>4.324 €</b>	CS8C-158258AS	6,57	2580	2100	<b>3.556 €</b>
	CS8C-158258BC	7,23	2580	2400	<b>4.541 €</b>	CS8C-158258BS	7,23	2580	2300	<b>3.775 €</b>
	CS8C-158258CC	7,88	2580	2600	<b>4.762 €</b>	CS8C-158258CS	7,88	2580	2500	<b>3.993 €</b>
<b>CS9</b>	CS9C-158278AC	7,12	2780	2200	<b>4.540 €</b>	CS9C-158278AS	7,12	2780	2100	<b>3.703 €</b>
	CS9C-158278BC	7,83	2780	2400	<b>4.766 €</b>	CS9C-158278BS	7,83	2780	2300	<b>3.936 €</b>
	CS9C-158278CC	8,54	2780	2600	<b>5.000 €</b>	CS9C-158278CS	8,54	2780	2500	<b>4.167 €</b>
<b>CS10</b>	CS10C-158298AC	7,67	2980	2200	<b>4.759 €</b>	CS10C-158298AS	7,67	2980	2100	<b>3.858 €</b>
	CS10C-158298BC	8,44	2980	2400	<b>4.995 €</b>	CS10C-158298BS	8,44	2980	2300	<b>4.098 €</b>
	CS10C-158298CC	9,21	2980	2600	<b>5.235 €</b>	CS10C-158298CS	9,21	2980	2500	<b>4.347 €</b>
<b>CS11</b>	CS11C-158318AC	8,22	3180	2200	<b>4.973 €</b>	CS11C-158318AS	8,22	3180	2100	<b>4.009 €</b>
	CS11C-158318BC	9,05	3180	2400	<b>5.223 €</b>	CS11C-158318BS	9,05	3180	2300	<b>4.265 €</b>
	CS11C-158318CC	9,87	3180	2600	<b>5.479 €</b>	CS11C-158318CS	9,87	3180	2500	<b>4.516 €</b>
<b>CS12</b>	CS12C-158338AC	8,78	3380	2200	<b>5.182 €</b>	CS12C-158338AS	8,78	3380	2100	<b>4.163 €</b>
	CS12C-158338BC	9,65	3380	2400	<b>5.449 €</b>	CS12C-158338BS	9,65	3380	2300	<b>4.434 €</b>
	CS12C-158338CC	10,53	3380	2600	<b>5.716 €</b>	CS12C-158338CS	10,53	3380	2500	<b>4.697 €</b>
<b>CS13</b>	CS13C-158358AC	9,33	3580	2200	<b>5.400 €</b>	CS13C-158358AS	9,33	3580	2100	<b>4.321 €</b>
	CS13C-158358BC	10,26	3580	2400	<b>5.674 €</b>	CS13C-158358BS	10,26	3580	2300	<b>4.591 €</b>
	CS13C-158358CC	11,19	3580	2600	<b>5.948 €</b>	CS13C-158358CS	11,19	3580	2500	<b>4.870 €</b>

80	Largo - Length (L)																			
	1140	1340	1540	1740	1940	2140	2340	2540	2740	2940	3140	3340	3540	3740	3940	4140	4340	4540	4740	4940
Fondo - Depth mm 1740				DS4	DS5	DS6	DS7	DS8	DS9	DS10	DS11	DS12	DS13	DS14						

80	CON suelo - WITH floor panel					SIN suelo - WITHOUT floor panel				
	COD	m²	L	H	€	COD	m²	L	H	€
DS4	DS4R-174174AC	4,99	1740	2160	<b>3.316 €</b>	DS4R-174174AS	4,99	1740	2080	<b>2.778 €</b>
	DS4R-174174BC	5,49	1740	2360	<b>3.490 €</b>	DS4R-174174BS	5,49	1740	2280	<b>2.950 €</b>
	DS4R-174174CC	5,99	1740	2560	<b>3.663 €</b>	DS4R-174174CS	5,99	1740	2480	<b>3.122 €</b>
DS5	DS5R-174194AC	5,62	1940	2160	<b>3.525 €</b>	DS5R-174194AS	5,62	1940	2080	<b>2.923 €</b>
	DS5R-174194BC	6,19	1940	2360	<b>3.713 €</b>	DS5R-174194BS	6,19	1940	2280	<b>3.104 €</b>
	DS5R-174194CC	6,75	1940	2560	<b>3.897 €</b>	DS5R-174194CS	6,75	1940	2480	<b>3.286 €</b>
DS6	DS6R-174214AC	6,26	2140	2160	<b>3.739 €</b>	DS6R-174214AS	6,26	2140	2080	<b>3.068 €</b>
	DS6R-174214BC	6,88	2140	2360	<b>3.931 €</b>	DS6R-174214BS	6,88	2140	2280	<b>3.260 €</b>
	DS6R-174214CC	7,51	2140	2560	<b>4.122 €</b>	DS6R-174214CS	7,51	2140	2480	<b>3.455 €</b>
DS7	DS7R-174234AC	6,89	2340	2160	<b>3.953 €</b>	DS7R-174234AS	6,89	2340	2080	<b>3.213 €</b>
	DS7R-174234BC	7,58	2340	2360	<b>4.156 €</b>	DS7R-174234BS	7,58	2340	2280	<b>3.415 €</b>
	DS7R-174234CC	8,27	2340	2560	<b>4.359 €</b>	DS7R-174234CS	8,27	2340	2480	<b>3.616 €</b>
DS8	DS8R-174254AC	7,52	2540	2160	<b>4.159 €</b>	DS8R-174254AS	7,52	2540	2080	<b>3.357 €</b>
	DS8R-174254BC	8,27	2540	2360	<b>4.378 €</b>	DS8R-174254BS	8,27	2540	2280	<b>3.575 €</b>
	DS8R-174254CC	9,02	2540	2560	<b>4.587 €</b>	DS8R-174254CS	9,02	2540	2480	<b>3.787 €</b>
DS9	DS9R-174274AC	8,15	2740	2160	<b>4.375 €</b>	DS9R-174274AS	8,15	2740	2080	<b>3.506 €</b>
	DS9R-174274BC	8,97	2740	2360	<b>4.592 €</b>	DS9R-174274BS	8,97	2740	2280	<b>3.726 €</b>
	DS9R-174274CC	9,78	2740	2560	<b>4.819 €</b>	DS9R-174274CS	9,78	2740	2480	<b>3.953 €</b>
DS10	DS10R-174294AC	8,78	2940	2160	<b>4.584 €</b>	DS10R-174294AS	8,78	2940	2080	<b>3.651 €</b>
	DS10R-174294BC	9,66	2940	2360	<b>4.816 €</b>	DS10R-174294BS	9,66	2940	2280	<b>3.887 €</b>
	DS10R-174294CC	10,54	2940	2560	<b>5.044 €</b>	DS10R-174294CS	10,54	2940	2480	<b>4.116 €</b>
DS11	DS11R-174314AC	9,42	3140	2160	<b>4.792 €</b>	DS11R-174314AS	9,42	3140	2080	<b>3.801 €</b>
	DS11R-174314BC	10,36	3140	2360	<b>5.039 €</b>	DS11R-174314BS	10,36	3140	2280	<b>4.040 €</b>
	DS11R-174314CC	11,3	3140	2560	<b>5.273 €</b>	DS11R-174314CS	11,3	3140	2480	<b>4.280 €</b>
DS12	DS12R-174334AC	10,05	3340	2160	<b>5.003 €</b>	DS12R-174334AS	10,05	3340	2080	<b>3.944 €</b>
	DS12R-174334BC	11,05	3340	2360	<b>5.255 €</b>	DS12R-174334BS	11,05	3340	2280	<b>4.194 €</b>
	DS12R-174334CC	12,06	3340	2560	<b>5.504 €</b>	DS12R-174334CS	12,06	3340	2480	<b>4.450 €</b>
DS13	DS13R-174354AC	10,68	3540	2160	<b>5.222 €</b>	DS13R-174354AS	10,68	3540	2080	<b>4.089 €</b>
	DS13R-174354BC	11,75	3540	2360	<b>5.479 €</b>	DS13R-174354BS	11,75	3540	2280	<b>4.352 €</b>
	DS13R-174354CC	12,82	3540	2560	<b>5.743 €</b>	DS13R-174354CS	12,82	3540	2480	<b>4.612 €</b>
DS14	DS14R-174374AC	11,31	3740	2160	<b>5.431 €</b>	DS14R-174374AS	11,31	3740	2080	<b>4.236 €</b>
	DS14R-174374BC	12,44	3740	2360	<b>5.699 €</b>	DS14R-174374BS	12,44	3740	2280	<b>4.506 €</b>
	DS14R-174374CC	13,58	3740	2560	<b>6.040 €</b>	DS14R-174374CS	13,58	3740	2480	<b>4.777 €</b>

100	Largo - Length (L)																			
	1180	1380	1580	1780	1980	2180	2380	2580	2780	2980	3180	3380	3580	3780	3980	4180	4380	4580	4780	4980
Fondo - Depth mm 1780				DS4	DS5	DS6	DS7	DS8	DS9	DS10	DS11	DS12	DS13	DS14						

100	CON suelo - WITH floor panel					SIN suelo - WITHOUT floor panel				
	COD	m²	L	H	€	COD	m²	L	H	€
DS4	DS4C-178178AC	4,99	1780	2200	<b>3.690 €</b>	DS4C-178178AS	4,99	1780	2100	<b>3.100 €</b>
	DS4C-178178BC	5,49	1780	2400	<b>3.879 €</b>	DS4C-178178BS	5,49	1780	2300	<b>3.283 €</b>
	DS4C-178178CC	5,99	1780	2600	<b>4.071 €</b>	DS4C-178178CS	5,99	1780	2500	<b>3.476 €</b>
DS5	DS5C-178198AC	5,62	1980	2200	<b>3.921 €</b>	DS5C-178198AS	5,62	1980	2100	<b>3.256 €</b>
	DS5C-178198BC	6,19	1980	2400	<b>4.122 €</b>	DS5C-178198BS	6,19	1980	2300	<b>3.454 €</b>
	DS5C-178198CC	6,75	1980	2600	<b>4.315 €</b>	DS5C-178198CS	6,75	1980	2500	<b>3.657 €</b>
DS6	DS6C-178218AC	6,26	2180	2200	<b>4.147 €</b>	DS6C-178218AS	6,26	2180	2100	<b>3.417 €</b>
	DS6C-178218BC	6,88	2180	2400	<b>4.358 €</b>	DS6C-178218BS	6,88	2180	2300	<b>3.624 €</b>
	DS6C-178218CC	7,51	2180	2600	<b>4.572 €</b>	DS6C-178218CS	7,51	2180	2500	<b>3.833 €</b>
DS7	DS7C-178238AC	6,89	2380	2200	<b>4.375 €</b>	DS7C-178238AS	6,89	2380	2100	<b>3.577 €</b>
	DS7C-178238BC	7,58	2380	2400	<b>4.597 €</b>	DS7C-178238BS	7,58	2380	2300	<b>3.796 €</b>
	DS7C-178238CC	8,27	2380	2600	<b>4.820 €</b>	DS7C-178238CS	8,27	2380	2500	<b>4.017 €</b>
DS8	DS8C-178258AC	7,52	2580	2200	<b>4.610 €</b>	DS8C-178258AS	7,52	2580	2100	<b>3.731 €</b>
	DS8C-178258BC	8,27	2580	2400	<b>4.834 €</b>	DS8C-178258BS	8,27	2580	2300	<b>3.967 €</b>
	DS8C-178258CC	9,02	2580	2600	<b>5.074 €</b>	DS8C-178258CS	9,02	2580	2500	<b>4.197 €</b>
DS9	DS9C-178278AC	8,15	2780	2200	<b>4.835 €</b>	DS9C-178278AS	8,15	2780	2100	<b>3.891 €</b>
	DS9C-178278BC	8,97	2780	2400	<b>5.079 €</b>	DS9C-178278BS	8,97	2780	2300	<b>4.132 €</b>
	DS9C-178278CC	9,78	2780	2600	<b>5.325 €</b>	DS9C-178278CS	9,78	2780	2500	<b>4.381 €</b>
DS10	DS10C-178298AC	8,78	2980	2200	<b>5.064 €</b>	DS10C-178298AS	8,78	2980	2100	<b>4.051 €</b>
	DS10C-178298BC	9,66	2980	2400	<b>5.314 €</b>	DS10C-178298BS	9,66	2980	2300	<b>4.300 €</b>
	DS10C-178298CC	10,54	2980	2600	<b>5.780 €</b>	DS10C-178298CS	10,54	2980	2500	<b>4.554 €</b>
DS11	DS11C-178318AC	9,42	3180	2200	<b>5.292 €</b>	DS11C-178318AS	9,42	3180	2100	<b>4.206 €</b>
	DS11C-178318BC	10,36	3180	2400	<b>5.562 €</b>	DS11C-178318BS	10,36	3180	2300	<b>4.470 €</b>
	DS11C-178318CC	11,30	3180	2600	<b>6.027 €</b>	DS11C-178318CS	11,3	3180	2500	<b>4.738 €</b>
DS12	DS12C-178338AC	10,05	3380	2200	<b>5.519 €</b>	DS12C-178338AS	10,05	3380	2100	<b>4.363 €</b>
	DS12C-178338BC	11,05	3380	2400	<b>6.003 €</b>	DS12C-178338BS	11,05	3380	2300	<b>4.640 €</b>
	DS12C-178338CC	12,06	3380	2600	<b>6.270 €</b>	DS12C-178338CS	12,06	3380	2500	<b>4.915 €</b>
DS13	DS13C-178358AC	10,68	3580	2200	<b>5.959 €</b>	DS13C-178358AS	10,68	3580	2100	<b>4.530 €</b>
	DS13C-178358BC	11,75	3580	2400	<b>6.234 €</b>	DS13C-178358BS	11,75	3580	2300	<b>4.814 €</b>
	DS13C-178358CC	12,82	3580	2600	<b>6.523 €</b>	DS13C-178358CS	12,82	3580	2500	<b>5.096 €</b>
DS14	DS14C-178378AC	11,31	3780	2200	<b>6.189 €</b>	DS14C-178378AS	11,31	3780	2100	<b>4.686 €</b>
	DS14C-178378BC	12,44	3780	2400	<b>6.483 €</b>	DS14C-178378BS	12,44	3780	2300	<b>4.986 €</b>
	DS14C-178378CC	13,58	3780	2600	<b>6.635 €</b>	DS14C-178378CS	13,58	3780	2500	<b>5.281 €</b>

<b>80</b>	Largo - Length (L)																			
	1140	1340	1540	1740	1940	2140	2340	2540	2740	2940	3140	3340	3540	3740	3940	4140	4340	4540	4740	4940
Fondo - Depth mm					ES5	ES6	ES7	ES8	ES9	ES10	ES11	ES12	ES13	ES14	ES15					

80	CON suelo - WITH floor panel					SIN suelo - WITHOUT floor panel				
	COD	m <sup>2</sup>	L	H	€	COD	m <sup>2</sup>	L	H	€
ES5	ES5R-194194AC	6,34	1940	2160	3.754 €	ES5R-194194AS	6,34	1940	2080	3.071 €
	ES5R-194194BC	6,97	1940	2360	3.947 €	ES5R-194194BS	6,97	1940	2280	3.265 €
	ES5R-194194CC	7,6	1940	2560	4.134 €	ES5R-194194CS	7,6	1940	2480	3.459 €
ES6	ES6R-194214AC	7,05	2140	2160	3.973 €	ES6R-194214AS	7,05	2140	2080	3.221 €
	ES6R-194214BC	7,75	2140	2360	4.181 €	ES6R-194214BS	7,75	2140	2280	3.426 €
	ES6R-194214CC	8,46	2140	2560	4.380 €	ES6R-194214CS	8,46	2140	2480	3.626 €
ES7	ES7R-194234AC	7,76	2340	2160	4.203 €	ES7R-194234AS	7,76	2340	2080	3.374 €
	ES7R-194234BC	8,54	2340	2360	4.408 €	ES7R-194234BS	8,54	2340	2280	3.590 €
	ES7R-194234CC	9,31	2340	2560	4.625 €	ES7R-194234CS	9,31	2340	2480	3.800 €
ES8	ES8R-194254AC	8,47	2540	2160	4.423 €	ES8R-194254AS	8,47	2540	2080	3.525 €
	ES8R-194254BC	9,32	2540	2360	4.646 €	ES8R-194254BS	9,32	2540	2280	3.746 €
	ES8R-194254CC	10,17	2540	2560	4.866 €	ES8R-194254CS	10,17	2540	2480	3.968 €
ES9	ES9R-194274AC	9,18	2740	2160	4.651 €	ES9R-194274AS	9,18	2740	2080	3.673 €
	ES9R-194274BC	10,1	2740	2360	4.877 €	ES9R-194274BS	10,1	2740	2280	3.906 €
	ES9R-194274CC	11,02	2740	2560	5.110 €	ES9R-194274CS	11,02	2740	2480	4.140 €
ES10	ES10R-194294AC	9,9	2940	2160	4.867 €	ES10R-194294AS	9,9	2940	2080	3.829 €
	ES10R-194294BC	10,89	2940	2360	5.115 €	ES10R-194294BS	10,89	2940	2280	4.066 €
	ES10R-194294CC	11,88	2940	2560	5.351 €	ES10R-194294CS	11,88	2940	2480	4.311 €
ES11	ES11R-194314AC	10,61	3140	2160	5.092 €	ES11R-194314AS	10,61	3140	2080	3.974 €
	ES11R-194314BC	11,67	3140	2360	5.343 €	ES11R-194314BS	11,67	3140	2280	4.228 €
	ES11R-194314CC	12,73	3140	2560	5.601 €	ES11R-194314CS	12,73	3140	2480	4.482 €
ES12	ES12R-194334AC	11,32	3340	2160	5.314 €	ES12R-194334AS	11,32	3340	2080	4.125 €
	ES12R-194334BC	12,45	3340	2360	5.575 €	ES12R-194334BS	12,45	3340	2280	4.393 €
	ES12R-194334CC	13,58	3340	2560	5.841 €	ES12R-194334CS	13,58	3340	2480	4.655 €
ES13	ES13R-194354AC	12,03	3540	2160	5.539 €	ES13R-194354AS	12,03	3540	2080	4.277 €
	ES13R-194354BC	13,24	3540	2360	5.814 €	ES13R-194354BS	13,24	3540	2280	4.550 €
	ES13R-194354CC	14,44	3540	2560	6.161 €	ES13R-194354CS	14,44	3540	2480	4.822 €
ES14	ES14R-194374AC	12,74	3740	2160	5.766 €	ES14R-194374AS	12,74	3740	2080	4.431 €
	ES14R-194374BC	14,02	3740	2360	6.121 €	ES14R-194374BS	14,02	3740	2280	4.714 €
	ES14R-194374CC	15,29	3740	2560	6.401 €	ES14R-194374CS	15,29	3740	2480	4.990 €
ES15	ES15R-194394AC	13,46	3940	2160	5.993 €	ES15R-194394AS	13,46	3940	2080	4.581 €
	ES15R-194394BC	14,8	3940	2360	6.350 €	ES15R-194394BS	14,8	3940	2280	4.867 €
	ES15R-194394CC	16,15	3940	2560	6.638 €	ES15R-194394CS	16,15	3940	2480	5.167 €

<b>100</b>	Largo - Length (L)																			
	1180	1380	1580	1780	1980	2180	2380	2580	2780	2980	3180	3380	3580	3780	3980	4180	4380	4580	4780	4980
Fondo - Depth mm					ES5	ES6	ES7	ES8	ES9	ES10	ES11	ES12	ES13	ES14	ES15					

100	CON suelo - WITH floor panel					SIN suelo - WITHOUT floor panel				
	COD	m <sup>2</sup>	L	H	€	COD	m <sup>2</sup>	L	H	€
ES5	ES5C-198198AC	6,34	1980	2200	4.161 €	ES5C-198198AS	6,34	1980	2100	3.421 €
	ES5C-198198BC	6,97	1980	2400	4.368 €	ES5C-198198BS	6,97	1980	2300	3.633 €
	ES5C-198198CC	7,60	1980	2600	4.583 €	ES5C-198198CS	7,6	1980	2500	3.839 €
ES6	ES6C-198218AC	7,05	2180	2200	4.408 €	ES6C-198218AS	7,05	2180	2100	3.584 €
	ES6C-198218BC	7,75	2180	2400	4.624 €	ES6C-198218BS	7,75	2180	2300	3.801 €
	ES6C-198218CC	8,46	2180	2600	4.848 €	ES6C-198218CS	8,46	2180	2500	4.024 €
ES7	ES7C-198238AC	7,76	2380	2200	4.649 €	ES7C-198238AS	7,76	2380	2100	3.750 €
	ES7C-198238BC	8,54	2380	2400	4.875 €	ES7C-198238BS	8,54	2380	2300	3.978 €
	ES7C-198238CC	9,31	2380	2600	5.111 €	ES7C-198238CS	9,31	2380	2500	4.210 €
ES8	ES8C-198258AC	8,47	2580	2200	4.885 €	ES8C-198258AS	8,47	2580	2100	3.912 €
	ES8C-198258BC	9,32	2580	2400	5.134 €	ES8C-198258BS	9,32	2580	2300	4.157 €
	ES8C-198258CC	10,17	2580	2600	5.372 €	ES8C-198258CS	10,17	2580	2500	4.394 €
ES9	ES9C-198278AC	9,18	2780	2200	5.135 €	ES9C-198278AS	9,18	2780	2100	4.073 €
	ES9C-198278BC	10,10	2780	2400	5.387 €	ES9C-198278BS	10,1	2780	2300	4.332 €
	ES9C-198278CC	11,02	2780	2600	5.848 €	ES9C-198278CS	11,02	2780	2500	4.588 €
ES10	ES10C-198298AC	9,90	2980	2200	5.372 €	ES10C-198298AS	9,9	2980	2100	4.238 €
	ES10C-198298BC	10,89	2980	2400	5.838 €	ES10C-198298BS	10,89	2980	2300	4.505 €
	ES10C-198298CC	11,88	2980	2600	6.107 €	ES10C-198298CS	11,88	2980	2500	4.764 €
ES11	ES11C-198318AC	10,61	3180	2200	5.825 €	ES11C-198318AS	10,61	3180	2100	4.405 €
	ES11C-198318BC	11,67	3180	2400	6.093 €	ES11C-198318BS	11,67	3180	2300	4.676 €
	ES11C-198318CC	12,73	3180	2600	6.371 €	ES11C-198318CS	12,73	3180	2500	4.954 €
ES12	ES12C-198338AC	11,32	3380	2200	6.065 €	ES12C-198338AS	11,32	3380	2100	4.566 €
	ES12C-198338BC	12,45	3380	2400	6.348 €	ES12C-198338BS	12,45	3380	2300	4.853 €
	ES12C-198338CC	13,58	3380	2600	6.632 €	ES12C-198338CS	13,58	3380	2500	5.140 €
ES13	ES13C-198358AC	12,03	3580	2200	6.301 €	ES13C-198358AS	12,03	3580	2100	4.728 €
	ES13C-198358BC	13,24	3580	2400	6.599 €	ES13C-198358BS	13,24	3580	2300	5.031 €
	ES13C-198358CC	14,44	3580	2600	6.757 €	ES13C-198358CS	14,44	3580	2500	5.319 €
ES14	ES14C-198378AC	12,74	3780	2200	6.547 €	ES14C-198378AS	12,74	3780	2100	4.899 €
	ES14C-198378BC	14,02	3780	2400	6.719 €	ES14C-198378BS	14,02	3780	2300	5.206 €
	ES14C-198378CC	15,29	3780	2600	7.016 €	ES14C-198378CS	15,29	3780	2500	5.718 €
ES15	ES15C-198398AC	13,46	3980	2200	6.647 €	ES15C-198398AS	13,46	3980	2100	5.056 €
	ES15C-198398BC	14,80	3980	2400	6.956 €	ES15C-198398BS	14,8	3980	2300	5.587 €
	ES15C-198398CC	16,15	3980	2600	7.277 €	ES15C-198398CS	16,15	3980	2500	5.898 €

80	Largo - Length (L)																				
	1140	1340	1540	1740	1940	2140	2340	2540	2740	2940	3140	3340	3540	3740	3940	4140	4340	4540	4740	4940	
Fondo - Depth mm 2140						FS6	FS7	FS8	FS9	FS10	FS11	FS12	FS13	FS14	FS15	FS16					

80	CON suelo - WITH floor panel					SIN suelo - WITHOUT floor panel				
	COD	m²	L	H	€	COD	m²	L	H	€
FS6	FS6R-214214AC	7,84	2140	2160	4.213 €	FS6R-214214AS	7,84	2140	2080	3.378 €
	FS6R-214214BC	8,62	2140	2360	4.428 €	FS6R-214214BS	8,62	2140	2280	3.592 €
	FS6R-214214CC	9,41	2140	2560	4.632 €	FS6R-214214CS	9,41	2140	2480	3.806 €
FS7	FS7R-214234AC	8,63	2340	2160	4.446 €	FS7R-214234AS	8,63	2340	2080	3.536 €
	FS7R-214234BC	9,5	2340	2360	4.676 €	FS7R-214234BS	9,5	2340	2280	3.755 €
	FS7R-214234CC	10,36	2340	2560	4.892 €	FS7R-214234CS	10,36	2340	2480	3.976 €
FS8	FS8R-214254AC	9,42	2540	2160	4.682 €	FS8R-214254AS	9,42	2540	2080	3.694 €
	FS8R-214254BC	10,37	2540	2360	4.922 €	FS8R-214254BS	10,37	2540	2280	3.926 €
	FS8R-214254CC	11,31	2540	2560	5.146 €	FS8R-214254CS	11,31	2540	2480	4.150 €
FS9	FS9R-214274AC	10,22	2740	2160	4.925 €	FS9R-214274AS	10,22	2740	2080	3.850 €
	FS9R-214274BC	11,24	2740	2360	5.163 €	FS9R-214274BS	11,24	2740	2280	4.084 €
	FS9R-214274CC	12,26	2740	2560	5.408 €	FS9R-214274CS	12,26	2740	2480	4.328 €
FS10	FS10R-214294AC	11,01	2940	2160	5.161 €	FS10R-214294AS	11,01	2940	2080	4.001 €
	FS10R-214294BC	12,11	2940	2360	5.412 €	FS10R-214294BS	12,11	2940	2280	4.257 €
	FS10R-214294CC	13,21	2940	2560	5.655 €	FS10R-214294CS	13,21	2940	2480	4.507 €
FS11	FS11R-214314AC	11,8	3140	2160	5.389 €	FS11R-214314AS	11,8	3140	2080	4.154 €
	FS11R-214314BC	12,98	3140	2360	5.659 €	FS11R-214314BS	12,98	3140	2280	4.414 €
	FS11R-214314CC	14,16	3140	2560	5.922 €	FS11R-214314CS	14,16	3140	2480	4.683 €
FS12	FS12R-214334AC	12,59	3340	2160	5.628 €	FS12R-214334AS	12,59	3340	2080	4.315 €
	FS12R-214334BC	13,85	3340	2360	5.907 €	FS12R-214334BS	13,85	3340	2280	4.587 €
	FS12R-214334CC	15,11	3340	2560	6.247 €	FS12R-214334CS	15,11	3340	2480	4.856 €
FS13	FS13R-214354AC	13,38	3540	2160	5.867 €	FS13R-214354AS	13,38	3540	2080	4.467 €
	FS13R-214354BC	14,72	3540	2360	6.220 €	FS13R-214354BS	14,72	3540	2280	4.750 €
	FS13R-214354CC	16,06	3540	2560	6.491 €	FS13R-214354CS	16,06	3540	2480	5.029 €
FS14	FS14R-214374AC	14,18	3740	2160	6.177 €	FS14R-214374AS	14,18	3740	2080	4.622 €
	FS14R-214374BC	15,59	3740	2360	6.458 €	FS14R-214374BS	15,59	3740	2280	4.914 €
	FS14R-214374CC	17,01	3740	2560	6.740 €	FS14R-214374CS	17,01	3740	2480	5.205 €
FS15	FS15R-214394AC	14,97	3940	2160	6.410 €	FS15R-214394AS	14,97	3940	2080	4.782 €
	FS15R-214394BC	16,47	3940	2360	6.699 €	FS15R-214394BS	16,47	3940	2280	5.076 €
	FS15R-214394CC	17,96	3940	2560	6.990 €	FS15R-214394CS	17,96	3940	2480	5.386 €
FS16	FS16R-214414AC	15,76	4140	2160	6.638 €	FS16R-214414AS	15,76	4140	2080	4.934 €
	FS16R-214414BC	17,34	4140	2360	6.940 €	FS16R-214414BS	17,34	4140	2280	5.241 €
	FS16R-214414CC	18,91	4140	2560	7.238 €	FS16R-214414CS	18,91	4140	2480	5.556 €

100	Largo - Length (L)																				
	1180	1380	1580	1780	1980	2180	2380	2580	2780	2980	3180	3380	3580	3780	3980	4180	4380	4580	4780	4980	
Fondo - Depth mm 2180						FS6	FS7	FS8	FS9	FS10	FS11	FS12	FS13	FS14	FS15	FS16					

100	CON suelo - WITH floor panel					SIN suelo - WITHOUT floor panel				
	COD	m²	L	H	€	COD	m²	L	H	€
FS6	FS6C-218218AC	7,84	2180	2200	4.662 €	FS6C-218218AS	7,84	2180	2100	3.752 €
	FS6C-218218BC	8,62	2180	2400	4.892 €	FS6C-218218BS	8,62	2180	2300	3.984 €
	FS6C-218218CC	9,41	2180	2600	5.128 €	FS6C-218218CS	9,41	2180	2500	4.218 €
FS7	FS7C-218238AC	8,63	2380	2200	4.921 €	FS7C-218238AS	8,63	2380	2100	3.924 €
	FS7C-218238BC	9,50	2380	2400	5.162 €	FS7C-218238BS	9,5	2380	2300	4.164 €
	FS7C-218238CC	10,36	2380	2600	5.400 €	FS7C-218238CS	10,36	2380	2500	4.412 €
FS8	FS8C-218258AC	9,42	2580	2200	5.173 €	FS8C-218258AS	9,42	2580	2100	4.093 €
	FS8C-218258BC	10,37	2580	2400	5.432 €	FS8C-218258BS	10,37	2580	2300	4.343 €
	FS8C-218258CC	11,31	2580	2600	5.878 €	FS8C-218258CS	11,31	2580	2500	4.596 €
FS9	FS9C-218278AC	10,22	2780	2200	5.429 €	FS9C-218278AS	10,22	2780	2100	4.265 €
	FS9C-218278BC	11,24	2780	2400	5.893 €	FS9C-218278BS	11,24	2780	2300	4.528 €
	FS9C-218278CC	12,26	2780	2600	6.163 €	FS9C-218278CS	12,26	2780	2500	4.790 €
FS10	FS10C-218298AC	11,01	2980	2200	5.885 €	FS10C-218298AS	11,01	2980	2100	4.428 €
	FS10C-218298BC	12,11	2980	2400	6.169 €	FS10C-218298BS	12,11	2980	2300	4.705 €
	FS10C-218298CC	13,21	2980	2600	6.440 €	FS10C-218298CS	13,21	2980	2500	4.978 €
FS11	FS11C-218318AC	11,80	3180	2200	6.148 €	FS11C-218318AS	11,8	3180	2100	4.596 €
	FS11C-218318BC	12,98	3180	2400	6.425 €	FS11C-218318BS	12,98	3180	2300	4.884 €
	FS11C-218318CC	14,16	3180	2600	6.575 €	FS11C-218318CS	14,16	3180	2500	5.170 €
FS12	FS12C-218338AC	12,59	3380	2200	6.400 €	FS12C-218338AS	12,59	3380	2100	4.774 €
	FS12C-218338BC	13,85	3380	2400	6.700 €	FS12C-218338BS	13,85	3380	2300	5.067 €
	FS12C-218338CC	15,11	3380	2600	6.851 €	FS12C-218338CS	15,11	3380	2500	5.571 €
FS13	FS13C-218358AC	13,38	3580	2200	6.653 €	FS13C-218358AS	13,38	3580	2100	4.944 €
	FS13C-218358BC	14,72	3580	2400	6.813 €	FS13C-218358BS	14,72	3580	2300	5.247 €
	FS13C-218358CC	16,06	3580	2600	7.126 €	FS13C-218358CS	16,06	3580	2500	5.757 €
FS14	FS14C-218378AC	14,18	3780	2200	6.763 €	FS14C-218378AS	14,18	3780	2100	5.111 €
	FS14C-218378BC	15,59	3780	2400	7.084 €	FS14C-218378BS	15,59	3780	2300	5.629 €
	FS14C-218378CC	17,01	3780	2600	7.394 €	FS14C-218378CS	17,01	3780	2500	5.953 €
FS15	FS15C-218398AC	14,97	3980	2200	7.024 €	FS15C-218398AS	14,97	3980	2100	5.280 €
	FS15C-218398BC	16,47	3980	2400	7.347 €	FS15C-218398BS	16,47	3980	2300	5.806 €
	FS15C-218398CC	17,96	3980	2600	7.660 €	FS15C-218398CS	17,96	3980	2500	6.142 €
FS16	FS16C-218418AC	15,76	4180	2200	7.277 €	FS16C-218418AS	15,76	4180	2100	5.648 €
	FS16C-218418BC	17,34	4180	2400	7.609 €	FS16C-218418BS	17,34	4180	2300	5.993 €
	FS16C-218418CC	18,91	4180	2600	7.934 €	FS16C-218418CS	18,91	4180	2500	6.198 €



80	Largo - Length (L)																						
	1140	1340	1540	1740	1940	2140	2340	2540	2740	2940	3140	3340	3540	3740	3940	4140	4340	4540	4740	4940			
Fondo - Depth mm 2340							GS7	GS8	GS9	GS10	GS11	GS12	GS13	GS14	GS15	GS16	GS17						

80	CON suelo - WITH floor panel					SIN suelo - WITHOUT floor panel				
	COD	m²	L	H	€	COD	m²	L	H	€
GS7	GS7R-234234AC	9,5	2340	2160	4.695 €	GS7R-234234AS	9,5	2340	2080	3.697 €
	GS7R-234234BC	10,46	2340	2360	4.929 €	GS7R-234234BS	10,46	2340	2280	3.929 €
	GS7R-234234CC	11,41	2340	2560	5.166 €	GS7R-234234CS	11,41	2340	2480	4.164 €
GS8	GS8R-234254AC	10,38	2540	2160	4.951 €	GS8R-234254AS	10,38	2540	2080	3.856 €
	GS8R-234254BC	11,41	2540	2360	5.189 €	GS8R-234254BS	11,41	2540	2280	4.098 €
	GS8R-234254CC	12,45	2540	2560	5.429 €	GS8R-234254CS	12,45	2540	2480	4.339 €
GS9	GS9R-234274AC	11,25	2740	2160	5.194 €	GS9R-234274AS	11,25	2740	2080	4.019 €
	GS9R-234274BC	12,37	2740	2360	5.449 €	GS9R-234274BS	12,37	2740	2280	4.268 €
	GS9R-234274CC	13,5	2740	2560	5.693 €	GS9R-234274CS	13,5	2740	2480	4.518 €
GS10	GS10R-234294AC	12,12	2940	2160	5.444 €	GS10R-234294AS	12,12	2940	2080	4.177 €
	GS10R-234294BC	13,33	2940	2360	5.709 €	GS10R-234294BS	13,33	2940	2280	4.438 €
	GS10R-234294CC	14,54	2940	2560	5.967 €	GS10R-234294CS	14,54	2940	2480	4.701 €
GS11	GS11R-234314AC	12,99	3140	2160	5.694 €	GS11R-234314AS	12,99	3140	2080	4.337 €
	GS11R-234314BC	14,29	3140	2360	5.964 €	GS11R-234314BS	14,29	3140	2280	4.611 €
	GS11R-234314CC	15,59	3140	2560	6.303 €	GS11R-234314CS	15,59	3140	2480	4.877 €
GS12	GS12R-234334AC	13,86	3340	2160	5.949 €	GS12R-234334AS	13,86	3340	2080	4.494 €
	GS12R-234334BC	15,25	3340	2360	6.293 €	GS12R-234334BS	15,25	3340	2280	4.777 €
	GS12R-234334CC	16,64	3340	2560	6.574 €	GS12R-234334CS	16,64	3340	2480	5.060 €
GS13	GS13R-234354AC	14,74	3540	2160	6.258 €	GS13R-234354AS	14,74	3540	2080	4.663 €
	GS13R-234354BC	16,21	3540	2360	6.542 €	GS13R-234354BS	16,21	3540	2280	4.953 €
	GS13R-234354CC	17,68	3540	2560	6.831 €	GS13R-234354CS	17,68	3540	2480	5.241 €
GS14	GS14R-234374AC	15,61	3740	2160	6.513 €	GS14R-234374AS	15,61	3740	2080	4.821 €
	GS14R-234374BC	17,17	3740	2360	6.803 €	GS14R-234374BS	17,17	3740	2280	5.122 €
	GS14R-234374CC	18,73	3740	2560	7.088 €	GS14R-234374CS	18,73	3740	2480	5.426 €
GS15	GS15R-234394AC	16,48	3940	2160	6.753 €	GS15R-234394AS	16,48	3940	2080	4.985 €
	GS15R-234394BC	18,13	3940	2360	7.052 €	GS15R-234394BS	18,13	3940	2280	5.293 €
	GS15R-234394CC	19,78	3940	2560	7.350 €	GS15R-234394CS	19,78	3940	2480	5.606 €
GS16	GS16R-234414AC	17,35	4140	2160	6.991 €	GS16R-234414AS	17,35	4140	2080	5.139 €
	GS16R-234414BC	19,09	4140	2360	7.298 €	GS16R-234414BS	19,09	4140	2280	5.465 €
	GS16R-234414CC	20,82	4140	2560	7.614 €	GS16R-234414CS	20,82	4140	2480	5.865 €
GS17	GS17R-234434AC	18,22	4340	2160	7.232 €	GS17R-234434AS	18,22	4340	2080	5.299 €
	GS17R-234434BC	20,05	4340	2360	7.552 €	GS17R-234434BS	20,05	4340	2280	5.714 €
	GS17R-234434CC	21,87	4340	2560	7.887 €	GS17R-234434CS	21,87	4340	2480	6.041 €

100	Largo - Length (L)																						
	1180	1380	1580	1780	1980	2180	2380	2580	2780	2980	3180	3380	3580	3780	3980	4180	4380	4580	4780	4980			
Fondo - Depth mm 2380							GS7	GS8	GS9	GS10	GS11	GS12	GS13	GS14	GS15	GS16	GS17						

100	CON suelo - WITH floor panel					SIN suelo - WITHOUT floor panel				
	COD	m²	L	H	€	COD	m²	L	H	€
GS7	GS7C-238238AC	9,5	2380	2200	5.189 €	GS7C-238238AS	9,5	2380	2100	4.097 €
	GS7C-238238BC	10,46	2380	2400	5.438 €	GS7C-238238BS	10,46	2380	2300	4.355 €
	GS7C-238238CC	11,41	2380	2600	5.900 €	GS7C-238238CS	11,41	2380	2500	4.603 €
GS8	GS8C-238258AC	10,38	2580	2200	5.456 €	GS8C-238258AS	10,38	2580	2100	4.276 €
	GS8C-238258BC	11,41	2580	2400	5.928 €	GS8C-238258BS	11,41	2580	2300	4.539 €
	GS8C-238258CC	12,45	2580	2600	6.185 €	GS8C-238258CS	12,45	2580	2500	4.798 €
GS9	GS9C-238278AC	11,25	2780	2200	5.924 €	GS9C-238278AS	11,25	2780	2100	4.451 €
	GS9C-238278BC	12,37	2780	2400	6.200 €	GS9C-238278BS	12,37	2780	2300	4.727 €
	GS9C-238278CC	13,5	2780	2600	6.474 €	GS9C-238278CS	13,5	2780	2500	4.995 €
GS10	GS10C-238298AC	12,12	2980	2200	6.198 €	GS10C-238298AS	12,12	2980	2100	4.623 €
	GS10C-238298BC	13,33	2980	2400	6.492 €	GS10C-238298BS	13,33	2980	2300	4.912 €
	GS10C-238298CC	14,54	2980	2600	6.633 €	GS10C-238298CS	14,54	2980	2500	5.194 €
GS11	GS11C-238318AC	12,99	3180	2200	6.471 €	GS11C-238318AS	12,99	3180	2100	4.795 €
	GS11C-238318BC	14,29	3180	2400	6.624 €	GS11C-238318BS	14,29	3180	2300	5.097 €
	GS11C-238318CC	15,59	3180	2600	6.922 €	GS11C-238318CS	15,59	3180	2500	5.598 €
GS12	GS12C-238338AC	13,86	3380	2200	6.746 €	GS12C-238338AS	13,86	3380	2100	4.977 €
	GS12C-238338BC	15,25	3380	2400	6.900 €	GS12C-238338BS	15,25	3380	2300	5.283 €
	GS12C-238338CC	16,64	3380	2600	7.203 €	GS12C-238338CS	16,64	3380	2500	5.794 €
GS13	GS13C-238358AC	14,74	3580	2200	6.864 €	GS13C-238358AS	14,74	3580	2100	5.148 €
	GS13C-238358BC	16,21	3580	2400	7.166 €	GS13C-238358BS	16,21	3580	2300	5.667 €
	GS13C-238358CC	17,68	3580	2600	7.478 €	GS13C-238358CS	17,68	3580	2500	5.980 €
GS14	GS14C-238378AC	15,61	3780	2200	7.123 €	GS14C-238378AS	15,61	3780	2100	5.118 €
	GS14C-238378BC	17,17	3780	2400	7.442 €	GS14C-238378BS	17,17	3780	2300	5.849 €
	GS14C-238378CC	18,73	3780	2600	7.768 €	GS14C-238378CS	18,73	3780	2500	6.188 €
GS15	GS15C-238398AC	16,48	3980	2200	7.393 €	GS15C-238398AS	16,48	3980	2100	5.705 €
	GS15C-238398BC	18,13	3980	2400	7.722 €	GS15C-238398BS	18,13	3980	2300	6.037 €
	GS15C-238398CC	19,78	3980	2600	8.049 €	GS15C-238398CS	19,78	3980	2500	6.253 €
GS16	GS16C-238418AC	17,35	4180	2200	7.651 €	GS16C-238418AS	17,35	4180	2100	5.868 €
	GS16C-238418BC	19,09	4180	2400	7.986 €	GS16C-238418BS	19,09	4180	2300	6.225 €
	GS16C-238418CC	20,82	4180	2600	8.328 €	GS16C-238418CS	20,82	4180	2500	6.438 €
GS17	GS17C-238438AC	18,22	4380	2200	7.925 €	GS17C-238438AS	18,22	4380	2100	6.049 €
	GS17C-238438BC	20,05	4380	2400	8.260 €	GS17C-238438BS	20,05	4380	2300	6.414 €
	GS17C-238438CC	21,87	4380	2600	8.622 €	GS17C-238438CS	21,87	4380	2500	6.625 €



80	Largo - Length (L)																								
	1140	1340	1540	1740	1940	2140	2340	2540	2740	2940	3140	3340	3540	3740	3940	4140	4340	4540	4740	4940					
Fondo - Depth mm 2540								HS8	HS9	HS10	HS11	HS12	HS13	HS14	HS15	HS16	HS17	HS18							

80	CON suelo - WITH floor panel					SIN suelo - WITHOUT floor panel				
	COD	m³	L	H	€	COD	m³	L	H	€
HS8	HS8R-254254AC	11,33	2540	2160	<b>5.208 €</b>	HS8R-254254AS	11,33	2540	2080	<b>4.023 €</b>
	HS8R-254254BC	12,46	2540	2360	<b>5.464 €</b>	HS8R-254254BS	12,46	2540	2280	<b>4.271 €</b>
	HS8R-254254CC	13,59	2540	2560	<b>5.707 €</b>	HS8R-254254CS	13,59	2540	2480	<b>4.523 €</b>
HS9	HS9R-254274AC	12,28	2740	2160	<b>5.472 €</b>	HS9R-254274AS	12,28	2740	2080	<b>4.190 €</b>
	HS9R-254274BC	13,51	2740	2360	<b>5.732 €</b>	HS9R-254274BS	13,51	2740	2280	<b>4.450 €</b>
	HS9R-254274CC	14,74	2740	2560	<b>6.067 €</b>	HS9R-254274CS	14,74	2740	2480	<b>4.707 €</b>
HS10	HS10R-254294AC	13,23	2940	2160	<b>5.731 €</b>	HS10R-254294AS	13,23	2940	2080	<b>4.348 €</b>
	HS10R-254294BC	14,56	2940	2360	<b>6.007 €</b>	HS10R-254294BS	14,56	2940	2280	<b>4.628 €</b>
	HS10R-254294CC	15,88	2940	2560	<b>6.343 €</b>	HS10R-254294CS	15,88	2940	2480	<b>4.890 €</b>
HS11	HS11R-254314AC	14,18	3140	2160	<b>5.993 €</b>	HS11R-254314AS	14,18	3140	2080	<b>4.521 €</b>
	HS11R-254314BC	15,6	3140	2360	<b>6.338 €</b>	HS11R-254314BS	15,6	3140	2280	<b>4.802 €</b>
	HS11R-254314CC	17,02	3140	2560	<b>6.616 €</b>	HS11R-254314CS	17,02	3140	2480	<b>5.078 €</b>
HS12	HS12R-254334AC	15,14	3340	2160	<b>6.321 €</b>	HS12R-254334AS	15,14	3340	2080	<b>4.685 €</b>
	HS12R-254334BC	16,65	3340	2360	<b>6.603 €</b>	HS12R-254334BS	16,65	3340	2280	<b>4.970 €</b>
	HS12R-254334CC	18,16	3340	2560	<b>6.892 €</b>	HS12R-254334CS	18,16	3340	2480	<b>5.266 €</b>
HS13	HS13R-254354AC	16,09	3540	2160	<b>6.584 €</b>	HS13R-254354AS	16,09	3540	2080	<b>4.847 €</b>
	HS13R-254354BC	17,7	3540	2360	<b>6.870 €</b>	HS13R-254354BS	17,7	3540	2280	<b>5.154 €</b>
	HS13R-254354CC	19,31	3540	2560	<b>7.171 €</b>	HS13R-254354CS	19,31	3540	2480	<b>5.448 €</b>
HS14	HS14R-254374AC	17,04	3740	2160	<b>6.830 €</b>	HS14R-254374AS	17,04	3740	2080	<b>5.012 €</b>
	HS14R-254374BC	18,74	3740	2360	<b>7.136 €</b>	HS14R-254374BS	18,74	3740	2280	<b>5.321 €</b>
	HS14R-254374CC	20,45	3740	2560	<b>7.440 €</b>	HS14R-254374CS	20,45	3740	2480	<b>5.726 €</b>
HS15	HS15R-254394AC	17,99	3940	2160	<b>7.091 €</b>	HS15R-254394AS	17,99	3940	2080	<b>5.179 €</b>
	HS15R-254394BC	19,79	3940	2360	<b>7.408 €</b>	HS15R-254394BS	19,79	3940	2280	<b>5.505 €</b>
	HS15R-254394CC	21,59	3940	2560	<b>7.722 €</b>	HS15R-254394CS	21,59	3940	2480	<b>5.905 €</b>
HS16	HS16R-254414AC	18,94	4140	2160	<b>7.086 €</b>	HS16R-254414AS	18,94	4140	2080	<b>5.349 €</b>
	HS16R-254414BC	20,84	4140	2360	<b>7.409 €</b>	HS16R-254414BS	20,84	4140	2280	<b>5.758 €</b>
	HS16R-254414CC	22,73	4140	2560	<b>7.718 €</b>	HS16R-254414CS	22,73	4140	2480	<b>6.089 €</b>
HS17	HS17R-254434AC	19,9	4340	2160	<b>7.601 €</b>	HS17R-254434AS	19,9	4340	2080	<b>5.514 €</b>
	HS17R-254434BC	21,89	4340	2360	<b>7.935 €</b>	HS17R-254434BS	21,89	4340	2280	<b>5.932 €</b>
	HS17R-254434CC	23,88	4340	2560	<b>8.261 €</b>	HS17R-254434CS	23,88	4340	2480	<b>6.260 €</b>
HS18	HS18R-254454AC	20,85	4540	2160	<b>7.853 €</b>	HS18R-254454AS	20,85	4540	2080	<b>5.759 €</b>
	HS18R-254454BC	22,93	4540	2360	<b>8.208 €</b>	HS18R-254454BS	22,93	4540	2280	<b>6.107 €</b>
	HS18R-254454CC	25,02	4540	2560	<b>8.546 €</b>	HS18R-254454CS	25,02	4540	2480	<b>6.448 €</b>

100	Largo - Length (L)																								
	1180	1380	1580	1780	1980	2180	2380	2580	2780	2980	3180	3380	3580	3780	3980	4180	4380	4580	4780	4980					
Fondo - Depth mm 2580								HS8	HS9	HS10	HS11	HS12	HS13	HS14	HS15	HS16	HS17	HS18							

100	CON suelo - WITH floor panel					SIN suelo - WITHOUT floor panel				
	COD	m³	L	H	€	COD	m³	L	H	€
HS8	HS8C-258258AC	11,33	2580	2200	<b>5.943 €</b>	HS8C-258258AS	11,33	2580	2100	<b>4.453 €</b>
	HS8C-258258BC	12,46	2580	2400	<b>6.217 €</b>	HS8C-258258BS	12,46	2580	2300	<b>4.723 €</b>
	HS8C-258258CC	13,59	2580	2600	<b>6.488 €</b>	HS8C-258258CS	13,59	2580	2500	<b>5.005 €</b>
HS9	HS9C-258278AC	12,28	2780	2200	<b>6.232 €</b>	HS9C-258278AS	12,28	2780	2100	<b>4.635 €</b>
	HS9C-258278BC	13,51	2780	2400	<b>6.508 €</b>	HS9C-258278BS	13,51	2780	2300	<b>4.923 €</b>
	HS9C-258278CC	14,74	2780	2600	<b>6.660 €</b>	HS9C-258278CS	14,74	2780	2500	<b>5.207 €</b>
HS10	HS10C-258298AC	13,23	2980	2200	<b>6.505 €</b>	HS10C-258298AS	13,23	2980	2100	<b>4.811 €</b>
	HS10C-258298BC	14,56	2980	2400	<b>6.668 €</b>	HS10C-258298BS	14,56	2980	2300	<b>5.107 €</b>
	HS10C-258298CC	15,88	2980	2600	<b>6.949 €</b>	HS10C-258298CS	15,88	2980	2500	<b>5.606 €</b>
HS11	HS11C-258318AC	14,18	3180	2200	<b>6.656 €</b>	HS11C-258318AS	14,18	3180	2100	<b>4.992 €</b>
	HS11C-258318BC	15,60	3180	2400	<b>6.957 €</b>	HS11C-258318BS	15,6	3180	2300	<b>5.509 €</b>
	HS11C-258318CC	17,02	3180	2600	<b>7.250 €</b>	HS11C-258318CS	17,02	3180	2500	<b>5.810 €</b>
HS12	HS12C-258338AC	15,14	3380	2200	<b>6.927 €</b>	HS12C-258338AS	15,14	3380	2100	<b>5.175 €</b>
	HS12C-258338BC	16,65	3380	2400	<b>7.240 €</b>	HS12C-258338BS	16,65	3380	2300	<b>5.690 €</b>
	HS12C-258338CC	18,16	3380	2600	<b>7.546 €</b>	HS12C-258338CS	18,16	3380	2500	<b>6.017 €</b>
HS13	HS13C-258358AC	16,09	3580	2200	<b>7.203 €</b>	HS13C-258358AS	16,09	3580	2100	<b>5.553 €</b>
	HS13C-258358BC	17,70	3580	2400	<b>7.524 €</b>	HS13C-258358BS	17,7	3580	2300	<b>5.887 €</b>
	HS13C-258358CC	19,31	3580	2600	<b>7.848 €</b>	HS13C-258358CS	19,31	3580	2500	<b>6.216 €</b>
HS14	HS14C-258378AC	17,04	3780	2200	<b>7.480 €</b>	HS14C-258378AS	17,04	3780	2100	<b>5.740 €</b>
	HS14C-258378BC	18,74	3780	2400	<b>7.807 €</b>	HS14C-258378BS	18,74	3780	2300	<b>6.082 €</b>
	HS14C-258378CC	20,45	3780	2600	<b>8.143 €</b>	HS14C-258378CS	20,45	3780	2500	<b>6.287 €</b>
HS15	HS15C-258398AC	17,99	3980	2200	<b>7.765 €</b>	HS15C-258398AS	17,99	3980	2100	<b>5.923 €</b>
	HS15C-258398BC	19,79	3980	2400	<b>8.100 €</b>	HS15C-258398BS	19,79	3980	2300	<b>6.273 €</b>
	HS15C-258398CC	21,59	3980	2600	<b>8.437 €</b>	HS15C-258398CS	21,59	3980	2500	<b>6.488 €</b>
HS16	HS16C-258418AC	18,94	4180	2200	<b>8.028 €</b>	HS16C-258418AS	18,94	4180	2100	<b>6.098 €</b>
	HS16C-258418BC	20,84	4180	2400	<b>8.389 €</b>	HS16C-258418BS	20,84	4180	2300	<b>6.325 €</b>
	HS16C-258418CC	22,73	4180	2600	<b>8.746 €</b>	HS16C-258418CS	22,73	4180	2500	<b>6.681 €</b>
HS17	HS17C-258438AC	19,90	4380	2200	<b>8.319 €</b>	HS17C-258438AS	19,9	4380	2100	<b>6.277 €</b>
	HS17C-258438BC	21,89	4380	2400	<b>8.677 €</b>	HS17C-258438BS	21,89	4380	2300	<b>6.509 €</b>
	HS17C-258438CC	23,88	4380	2600	<b>9.031 €</b>	HS17C-258438CS	23,88	4380	2500	<b>6.870 €</b>
HS18	HS18C-258458AC	20,85	4580	2200	<b>8.595 €</b>	HS18C-258458AS	20,85	4580	2100	<b>6.331 €</b>
	HS18C-258458BC	22,93	4580	2400	<b>8.955 €</b>	HS18C-258458BS	22,93	4580	2300	<b>6.706 €</b>
	HS18C-258458CC	25,02	4580	2600	<b>9.334 €</b>	HS18C-258458CS	25,02	4580	2500	<b>7.080 €</b>

<b>80</b>	Largo - Length (L)																		
	1140	1340	1540	1740	1940	2140	2340	2540	2740	2940	3140	3340	3540	3740	3940	4140	4340	4540	4740
Fondo - Depth mm 2740									JS9	JS10	JS11	JS12	JS13	JS14	JS15	JS16	JS17	JS18	JS19

80	CON suelo - WITH floor panel					SIN suelo - WITHOUT floor panel				
	COD	m²	L	H	€	COD	m²	L	H	€
JS9	JS9R-274274AC	13,31	2740	2160	5.751 €	JS9R-274274AS	13,31	2740	2080	4.360 €
	JS9R-274274BC	14,64	2740	2360	6.018 €	JS9R-274274BS	14,64	2740	2280	4.626 €
	JS9R-274274CC	15,98	2740	2560	6.349 €	JS9R-274274CS	15,98	2740	2480	4.693 €
JS10	JS10R-274294AC	14,34	2940	2160	6.017 €	JS10R-274294AS	14,34	2940	2080	4.527 €
	JS10R-274294BC	15,78	2940	2360	6.375 €	JS10R-274294BS	15,78	2940	2280	4.809 €
	JS10R-274294CC	17,21	2940	2560	6.649 €	JS10R-274294CS	17,21	2940	2480	5.087 €
JS11	JS11R-274314AC	15,38	3140	2160	6.369 €	JS11R-274314AS	15,38	3140	2080	4.702 €
	JS11R-274314BC	16,91	3140	2360	6.650 €	JS11R-274314BS	16,91	3140	2280	4.987 €
	JS11R-274314CC	18,45	3140	2560	6.925 €	JS11R-274314CS	18,45	3140	2480	5.285 €
JS12	JS12R-274334AC	16,41	3340	2160	6.630 €	JS12R-274334AS	16,41	3340	2080	4.868 €
	JS12R-274334BC	18,05	3340	2360	6.927 €	JS12R-274334BS	18,05	3340	2280	5.167 €
	JS12R-274334CC	19,69	3340	2560	7.223 €	JS12R-274334CS	19,69	3340	2480	5.474 €
JS13	JS13R-274354AC	17,44	3540	2160	6.904 €	JS13R-274354AS	17,44	3540	2080	5.042 €
	JS13R-274354BC	19,18	3540	2360	7.207 €	JS13R-274354BS	19,18	3540	2280	5.345 €
	JS13R-274354CC	20,93	3540	2560	7.502 €	JS13R-274354CS	20,93	3540	2480	5.750 €
JS14	JS14R-274374AC	18,47	3740	2160	7.169 €	JS14R-274374AS	18,47	3740	2080	5.211 €
	JS14R-274374BC	20,32	3740	2360	7.475 €	JS14R-274374BS	20,32	3740	2280	5.534 €
	JS14R-274374CC	22,17	3740	2560	7.795 €	JS14R-274374CS	22,17	3740	2480	5.931 €
JS15	JS15R-274394AC	19,5	3940	2160	7.437 €	JS15R-274394AS	19,5	3940	2080	5.386 €
	JS15R-274394BC	21,46	3940	2360	7.750 €	JS15R-274394BS	21,46	3940	2280	5.794 €
	JS15R-274394CC	23,41	3940	2560	8.077 €	JS15R-274394CS	23,41	3940	2480	6.111 €
JS16	JS16R-274414AC	20,54	4140	2160	7.705 €	JS16R-274414AS	20,54	4140	2080	5.555 €
	JS16R-274414BC	22,59	4140	2360	8.033 €	JS16R-274414BS	22,59	4140	2280	5.971 €
	JS16R-274414CC	24,64	4140	2560	8.368 €	JS16R-274414CS	24,64	4140	2480	6.298 €
JS17	JS17R-274434AC	21,57	4340	2160	7.962 €	JS17R-274434AS	21,57	4340	2080	5.809 €
	JS17R-274434BC	23,73	4340	2360	8.312 €	JS17R-274434BS	23,73	4340	2280	6.143 €
	JS17R-274434CC	25,88	4340	2560	8.650 €	JS17R-274434CS	25,88	4340	2480	6.485 €
JS18	JS18R-274454AC	22,6	4540	2160	8.231 €	JS18R-274454AS	22,6	4540	2080	5.971 €
	JS18R-274454BC	24,86	4540	2360	8.591 €	JS18R-274454BS	24,86	4540	2280	6.317 €
	JS18R-274454CC	27,12	4540	2560	8.938 €	JS18R-274454CS	27,12	4540	2480	6.674 €
JS19	JS19R-274474AC	23,63	4740	2160	8.499 €	JS19R-274474AS	23,63	4740	2080	6.139 €
	JS19R-274474BC	26	4740	2360	8.866 €	JS19R-274474BS	26	4740	2280	6.503 €
	JS19R-274474CC	28,36	4740	2560	9.101 €	JS19R-274474CS	28,36	4740	2480	6.853 €

<b>100</b>	Largo - Length (L)																		
	1180	1380	1580	1780	1980	2180	2380	2580	2780	2980	3180	3380	3580	3780	3980	4180	4380	4580	4780
Fondo - Depth mm 2780									JS9	JS10	JS11	JS12	JS13	JS14	JS15	JS16	JS17	JS18	JS19

100	CON suelo - WITH floor panel					SIN suelo - WITHOUT floor panel				
	COD	m²	L	H	€	COD	m²	L	H	€
JS9	JS9C-278278AC	13,31	2780	2200	6.518 €	JS9C-278278AS	13,31	2780	2100	4.814 €
	JS9C-278278BC	14,64	2780	2400	6.676 €	JS9C-278278BS	14,64	2780	2300	5.112 €
	JS9C-278278CC	15,98	2780	2600	6.960 €	JS9C-278278CS	15,98	2780	2500	5.611 €
JS10	JS10C-278298AC	14,34	2980	2200	6.677 €	JS10C-278298AS	14,34	2980	2100	5.003 €
	JS10C-278298BC	15,78	2980	2400	6.974 €	JS10C-278298BS	15,78	2980	2300	5.511 €
	JS10C-278298CC	17,21	2980	2600	7.271 €	JS10C-278298CS	17,21	2980	2500	5.822 €
JS11	JS11C-278318AC	15,38	3180	2200	6.969 €	JS11C-278318AS	15,38	3180	2100	5.194 €
	JS11C-278318BC	16,91	3180	2400	7.272 €	JS11C-278318BS	16,91	3180	2300	5.711 €
	JS11C-278318CC	18,45	3180	2600	7.581 €	JS11C-278318CS	18,45	3180	2500	6.031 €
JS12	JS12C-278338AC	16,41	3380	2200	7.265 €	JS12C-278338AS	16,41	3380	2100	5.377 €
	JS12C-278338BC	18,05	3380	2400	7.575 €	JS12C-278338BS	18,05	3380	2300	5.911 €
	JS12C-278338CC	19,69	3380	2600	7.902 €	JS12C-278338CS	19,69	3380	2500	6.237 €
JS13	JS13C-278358AC	17,44	3580	2200	7.550 €	JS13C-278358AS	17,44	3580	2100	5.766 €
	JS13C-278358BC	19,18	3580	2400	7.475 €	JS13C-278358BS	19,18	3580	2300	6.110 €
	JS13C-278358CC	20,93	3580	2600	8.202 €	JS13C-278358CS	20,93	3580	2500	6.306 €
JS14	JS14C-278378AC	18,47	3780	2200	7.840 €	JS14C-278378AS	18,47	3780	2100	5.953 €
	JS14C-278378BC	20,32	3780	2400	8.179 €	JS14C-278378BS	20,32	3780	2300	6.298 €
	JS14C-278378CC	22,17	3780	2600	8.523 €	JS14C-278378CS	22,17	3780	2500	6.519 €
JS15	JS15C-278398AC	19,5	3980	2200	8.121 €	JS15C-278398AS	19,5	3980	2100	6.139 €
	JS15C-278398BC	21,46	3980	2400	8.471 €	JS15C-278398BS	21,46	3980	2300	6.368 €
	JS15C-278398CC	23,41	3980	2600	8.834 €	JS15C-278398CS	23,41	3980	2500	6.710 €
JS16	JS16C-278418AC	20,54	4180	2200	8.414 €	JS16C-278418AS	20,54	4180	2100	6.327 €
	JS16C-278418BC	22,59	4180	2400	8.777 €	JS16C-278418BS	22,59	4180	2300	6.551 €
	JS16C-278418CC	24,64	4180	2600	9.151 €	JS16C-278418CS	24,64	4180	2500	6.918 €
JS17	JS17C-278438AC	21,57	4380	2200	8.715 €	JS17C-278438AS	21,57	4380	2100	6.379 €
	JS17C-278438BC	23,73	4380	2400	9.075 €	JS17C-278438BS	23,73	4380	2300	6.746 €
	JS17C-278438CC	25,88	4380	2600	9.451 €	JS17C-278438CS	25,88	4380	2500	7.116 €
JS18	JS18C-278458AC	22,6	4580	2200	9.002 €	JS18C-278458AS	22,6	4580	2100	6.552 €
	JS18C-278458BC	24,86	4580	2400	9.382 €	JS18C-278458BS	24,86	4580	2300	6.934 €
	JS18C-278458CC	27,12	4580	2600	9.763 €	JS18C-278458CS	27,12	4580	2500	7.317 €
JS19	JS19C-278478AC	23,63	4780	2200	9.286 €	JS19C-278478AS	23,63	4780	2100	6.736 €
	JS19C-278478BC	26	4780	2400	9.672 €	JS19C-278478BS	26	4780	2300	7.137 €
	JS19C-278478CC	28,36	4780	2600	9.929 €	JS19C-278478CS	28,36	4780	2500	7.528 €

80	Largo - Length (L)																			
	1140	1340	1540	1740	1940	2140	2340	2540	2740	2940	3140	3340	3540	3740	3940	4140	4340	4540	4740	4940
Fondo - Depth mm 2940										KS10	KS11	KS12	KS13	KS14	KS15	KS16	KS17	KS18	KS19	KS20

80	CON suelo - WITH floor panel					SIN suelo - WITHOUT floor panel				
	COD	m²	L	H	€	COD	m²	L	H	€
KS10	KS10R-294294AC	15,46	2940	2160	<b>6.369 €</b>	KS10R-294294AS	15,46	2940	2080	<b>4.698 €</b>
	KS10R-294294BC	17	2940	2360	<b>6.657 €</b>	KS10R-294294BS	17	2940	2280	<b>4.997 €</b>
	KS10R-294294CC	18,55	2940	2560	<b>6.949 €</b>	KS10R-294294CS	18,55	2940	2480	<b>5.286 €</b>
KS11	KS11R-294314AC	16,57	3140	2160	<b>6.662 €</b>	KS11R-294314AS	16,57	3140	2080	<b>4.877 €</b>
	KS11R-294314BC	18,23	3140	2360	<b>6.945 €</b>	KS11R-294314BS	18,23	3140	2280	<b>5.178 €</b>
	KS11R-294314CC	19,88	3140	2560	<b>7.240 €</b>	KS11R-294314CS	19,88	3140	2480	<b>5.486 €</b>
KS12	KS12R-294334AC	17,68	3340	2160	<b>6.940 €</b>	KS12R-294334AS	17,68	3340	2080	<b>5.056 €</b>
	KS12R-294334BC	19,45	3340	2360	<b>7.238 €</b>	KS12R-294334BS	19,45	3340	2280	<b>5.366 €</b>
	KS12R-294334CC	21,22	3340	2560	<b>7.535 €</b>	KS12R-294334CS	21,22	3340	2480	<b>5.764 €</b>
KS13	KS13R-294354AC	18,79	3540	2160	<b>7.214 €</b>	KS13R-294354AS	18,79	3540	2080	<b>5.227 €</b>
	KS13R-294354BC	20,67	3540	2360	<b>7.522 €</b>	KS13R-294354BS	20,67	3540	2280	<b>5.551 €</b>
	KS13R-294354CC	22,55	3540	2560	<b>7.842 €</b>	KS13R-294354CS	22,55	3540	2480	<b>5.952 €</b>
KS14	KS14R-294374AC	19,9	3740	2160	<b>7.498 €</b>	KS14R-294374AS	19,9	3740	2080	<b>5.405 €</b>
	KS14R-294374BC	21,9	3740	2360	<b>7.818 €</b>	KS14R-294374BS	21,9	3740	2280	<b>5.817 €</b>
	KS14R-294374CC	23,89	3740	2560	<b>8.139 €</b>	KS14R-294374CS	23,89	3740	2480	<b>6.142 €</b>
KS15	KS15R-294394AC	21,02	3940	2160	<b>7.781 €</b>	KS15R-294394AS	21,02	3940	2080	<b>5.584 €</b>
	KS15R-294394BC	23,12	3940	2360	<b>8.104 €</b>	KS15R-294394BS	23,12	3940	2280	<b>5.995 €</b>
	KS15R-294394CC	25,22	3940	2560	<b>8.443 €</b>	KS15R-294394CS	25,22	3940	2480	<b>6.334 €</b>
KS16	KS16R-294414AC	22,13	4140	2160	<b>8.064 €</b>	KS16R-294414AS	22,13	4140	2080	<b>5.841 €</b>
	KS16R-294414BC	24,34	4140	2360	<b>8.403 €</b>	KS16R-294414BS	24,34	4140	2280	<b>6.176 €</b>
	KS16R-294414CC	26,55	4140	2560	<b>8.741 €</b>	KS16R-294414CS	26,55	4140	2480	<b>6.528 €</b>
KS17	KS17R-294434AC	23,24	4340	2160	<b>8.346 €</b>	KS17R-294434AS	23,24	4340	2080	<b>6.008 €</b>
	KS17R-294434BC	25,56	4340	2360	<b>8.679 €</b>	KS17R-294434BS	25,56	4340	2280	<b>6.356 €</b>
	KS17R-294434CC	27,89	4340	2560	<b>9.029 €</b>	KS17R-294434CS	27,89	4340	2480	<b>6.719 €</b>
KS18	KS18R-294454AC	24,35	4540	2160	<b>8.625 €</b>	KS18R-294454AS	24,35	4540	2080	<b>6.180 €</b>
	KS18R-294454BC	26,79	4540	2360	<b>8.974 €</b>	KS18R-294454BS	26,79	4540	2280	<b>6.535 €</b>
	KS18R-294454CC	29,22	4540	2560	<b>9.214 €</b>	KS18R-294454CS	29,22	4540	2480	<b>6.904 €</b>
KS19	KS19R-294474AC	25,46	4740	2160	<b>8.904 €</b>	KS19R-294474AS	25,46	4740	2080	<b>6.359 €</b>
	KS19R-294474BC	28,01	4740	2360	<b>9.145 €</b>	KS19R-294474BS	28,01	4740	2280	<b>6.726 €</b>
	KS19R-294474CC	30,56	4740	2560	<b>9.509 €</b>	KS19R-294474CS	30,56	4740	2480	<b>7.088 €</b>
KS20	KS20R-294494AC	26,58	4940	2160	<b>9.186 €</b>	KS20R-294494AS	26,58	4940	2080	<b>6.527 €</b>
	KS20R-294494BC	29,23	4940	2360	<b>9.422 €</b>	KS20R-294494BS	29,23	4940	2280	<b>6.903 €</b>
	KS20R-294494CC	31,89	4940	2560	<b>9.810 €</b>	KS20R-294494CS	31,89	4940	2480	<b>7.286 €</b>

100	Largo - Length (L)																			
	1180	1380	1580	1780	1980	2180	2380	2580	2780	2980	3180	3380	3580	3780	3980	4180	4380	4580	4780	4980
Fondo - Depth mm 2980										KS10	KS11	KS12	KS13	KS14	KS15	KS16	KS17	KS18	KS19	KS20

100	CON suelo - WITH floor panel					SIN suelo - WITHOUT floor panel				
	COD	m²	L	H	€	COD	m²	L	H	€
KS10	KS10C-298298AC	15,46	2980	2200	<b>6.978 €</b>	KS10C-298298AS	15,46	2980	2100	<b>5.193 €</b>
	KS10C-298298BC	17	2980	2400	<b>7.297 €</b>	KS10C-298298BS	17	2980	2300	<b>5.715 €</b>
	KS10C-298298CC	18,55	2980	2600	<b>7.597 €</b>	KS10C-298298CS	18,55	2980	2500	<b>6.037 €</b>
KS11	KS11C-298318AC	16,57	3180	2200	<b>7.287 €</b>	KS11C-298318AS	16,57	3180	2100	<b>5.586 €</b>
	KS11C-298318BC	18,23	3180	2400	<b>7.605 €</b>	KS11C-298318BS	18,23	3180	2300	<b>5.912 €</b>
	KS11C-298318CC	19,88	3180	2600	<b>7.930 €</b>	KS11C-298318CS	19,88	3180	2500	<b>6.251 €</b>
KS12	KS12C-298338AC	17,68	3380	2200	<b>7.589 €</b>	KS12C-298338AS	17,68	3380	2100	<b>5.777 €</b>
	KS12C-298338BC	19,45	3380	2400	<b>7.924 €</b>	KS12C-298338BS	19,45	3380	2300	<b>6.115 €</b>
	KS12C-298338CC	21,22	3380	2600	<b>8.249 €</b>	KS12C-298338CS	21,22	3380	2500	<b>6.325 €</b>
KS13	KS13C-298358AC	18,79	3580	2200	<b>7.898 €</b>	KS13C-298358AS	18,79	3580	2100	<b>5.976 €</b>
	KS13C-298358BC	20,67	3580	2400	<b>8.233 €</b>	KS13C-298358BS	20,67	3580	2300	<b>6.321 €</b>
	KS13C-298358CC	22,55	3580	2600	<b>8.574 €</b>	KS13C-298358CS	22,55	3580	2500	<b>6.530 €</b>
KS14	KS14C-298378AC	19,9	3780	2200	<b>8.188 €</b>	KS14C-298378AS	19,9	3780	2100	<b>6.161 €</b>
	KS14C-298378BC	21,9	3780	2400	<b>8.544 €</b>	KS14C-298378BS	21,9	3780	2300	<b>6.396 €</b>
	KS14C-298378CC	23,89	3780	2600	<b>8.898 €</b>	KS14C-298378CS	23,89	3780	2500	<b>6.736 €</b>
KS15	KS15C-298398AC	21,02	3980	2200	<b>8.501 €</b>	KS15C-298398AS	21,02	3980	2100	<b>6.229 €</b>
	KS15C-298398BC	23,12	3980	2400	<b>8.863 €</b>	KS15C-298398BS	23,12	3980	2300	<b>6.583 €</b>
	KS15C-298398CC	25,22	3980	2600	<b>9.215 €</b>	KS15C-298398CS	25,22	3980	2500	<b>6.956 €</b>
KS16	KS16C-298418AC	22,13	4180	2200	<b>8.800 €</b>	KS16C-298418AS	22,13	4180	2100	<b>6.408 €</b>
	KS16C-298418BC	24,34	4180	2400	<b>9.171 €</b>	KS16C-298418BS	24,34	4180	2300	<b>6.790 €</b>
	KS16C-298418CC	26,55	4180	2600	<b>9.543 €</b>	KS16C-298418CS	26,55	4180	2500	<b>7.152 €</b>
KS17	KS17C-298438AC	23,24	4380	2200	<b>9.102 €</b>	KS17C-298438AS	23,24	4380	2100	<b>6.595 €</b>
	KS17C-298438BC	25,56	4380	2400	<b>9.478 €</b>	KS17C-298438BS	25,56	4380	2300	<b>6.984 €</b>
	KS17C-298438CC	27,89	4380	2600	<b>9.863 €</b>	KS17C-298438CS	27,89	4380	2500	<b>7.358 €</b>
KS18	KS18C-298458AC	24,35	4580	2200	<b>9.399 €</b>	KS18C-298458AS	24,35	4580	2100	<b>6.785 €</b>
	KS18C-298458BC	26,79	4580	2400	<b>9.793 €</b>	KS18C-298458BS	26,79	4580	2300	<b>7.179 €</b>
	KS18C-298458CC	29,22	4580	2600	<b>10.048 €</b>	KS18C-298458CS	29,22	4580	2500	<b>7.574 €</b>
KS19	KS19C-298478AC	25,46	4780	2200	<b>9.712 €</b>	KS19C-298478AS	25,46	4780	2100	<b>6.965 €</b>
	KS19C-298478BC	28,01	4780	2400	<b>9.973 €</b>	KS19C-298478BS	28,01	4780	2300	<b>7.369 €</b>
	KS19C-298478CC	30,56	4780	2600	<b>10.582 €</b>	KS19C-298478CS	30,56	4780	2500	<b>7.779 €</b>
KS20	KS20C-298498AC	26,58	4980	2200	<b>10.005 €</b>	KS20C-298498AS	26,58	4980	2100	<b>7.160 €</b>
	KS20C-298498BC	29,23	4980	2400	<b>10.289 €</b>	KS20C-298498BS	29,23	4980	2300	<b>7.566 €</b>
	KS20C-298498CC	31,89	4980	2600	<b>10.891 €</b>	KS20C-298498CS	31,89	4980	2500	<b>7.990 €</b>

11d

# Serie RFM-S



RECINTOS FRIGORÍFICOS ESPECIALES  
*SPECIAL MODULAR COLD ROOMS*



494



495

info@coreco.es · www.coldroomscoreco.com

CORECO desarrolla una gama de cámaras para aplicaciones especiales pensada para aquellos espacios donde la conservación debe convivir con la presentación del producto, la integración en el local y una imagen cuidada. Soluciones concebidas para vino, queso y carne, con una misma base constructiva y con elementos específicos según el uso final del recinto.

*CORECO has developed a range of cold rooms for special applications designed when preservation must coexist with product presentation, integration into the premises and a carefully considered appearance.*

*Solutions conceived for wine, cheese and meat, sharing the same construction base while incorporating specific elements according to the final use of the room.*



La propuesta parte de una cámara modular de imagen limpia y profesional, preparada para su integración en tiendas especializadas, restaurantes, espacios gourmet, zonas de maduración o áreas de exposición al público. La gama se apoya en una estética sobria, materiales resistentes y configuraciones que permiten adaptar la cámara a la aplicación sin perder coherencia de conjunto.

*The concept is based on a modular cold room with a clean, professional appearance, designed to integrate naturally into specialised shops, restaurants, gourmet spaces, ageing areas and public display environments. The range is built around a sober aesthetic, durable materials and configurations that allow the cold room to be adapted to each application while maintaining overall consistency.*

La diferenciación se consigue aplicando el acabado exterior e interior, equipo frigorífico y estanterías adecuadas para cada uso.

*Differentiation is achieved by applying the appropriate internal and exterior finishing, refrigeration unit and shelving for each specific use.*

#### ESTANDAR

- Exterior de panel en chapa de acero galvanizado prelacada con poliéster, disponible en color negro o blanco.
- Interior de panel en PVC blanco.
- Un lateral acristalado de serie.
- Una puerta con cristal de serie.

#### STANDARD

*Panel exterior in polyester pre-coated galvanised steel sheet, available in black or white.  
Panel interior in white PVC.  
One glazed side panel as standard.  
One glass door as standard.*

#### OPCIONES

- Dos o tres laterales acristalados.
- Acabados exteriores alternativos dentro de la gama estándar en negro o blanco.
- Interior en acero inoxidable
- Iluminación adaptada a la aplicación.
- Estanterías específicas según uso: vinoteca, queso o producto alimentario en formato modular.
- Equipos frigoríficos específicos para cada aplicación

#### OPTIONS

- *Two or three glazed side panels.*
- *Alternative exterior finishes within the standard range in black or white.*
- *Stainless steel interior.*
- *Lighting adapted to the application.*
- *Specific shelving according to use: wine cellar, cheese or food product in modular format.*
- *Specific refrigeration units for each application.*

#### PANELES

- Espesor de 80 mm
- Unión: sujeción por presión, llave incluida, fabricado en ABS de alta resistencia.
- Revestimiento estándar en acero galvanizado prelacado poliéster, con film de protección. Color blanco pirineo o negro

#### PANELS

- 80 mm thickness
- Joint system: pressure fastening, key included, made of high-resistance ABS.
- Standard cladding in pre-lacquered polyester galvanised steel, with protective film. Pyrenees white or black color

#### PUERTA

- Pivotante con apertura a mano derecha, puede colocarse en los 4 lados de la cámara
- Burlete desmontable con ajuste perimetral sobre el marco, asegura la estanqueidad
- Hueco de luz de puerta 1850 x 800 mm
- Cierre de un punto de presión, con llave exterior y desbloqueo interior

#### DOOR

- Hinged door with right-hand opening, can be fitted on any of the 4 sides of the cold room.
- Removable gasket with perimeter adjustment on the frame, ensuring a tight seal.
- Clear door opening: 1850 x 800 mm.
- Single-point pressure lock, with external key and internal release.

#### AISLAMIENTO

- Espuma rígida de poliuretano, libre de CFC e inyectado a alta presión
- Densidad 45 Kg. / m<sup>3</sup>
- Coeficiente de conductividad térmica 0.022W/mK a 10°C. (Sin envejecimiento)

#### INSULATION

- Rigid polyurethane foam, CFC-free and high-pressure injected.
- Density: 45 kg/m<sup>3</sup>.
- Thermal conductivity coefficient: 0.022 W/mK at 10°C (without ageing).

#### SUELO

- Suelo reforzado. Acabado interior de contrachapado de abedul y resina fenólica antideslizante.

#### FLOOR

- Reinforced floor. Interior finish in birch plywood with anti-slip phenolic resin.

#### PERFIL SANITARIO

- Diseño cóncavo, dos piezas más tapones esquineros en las uniones

#### HYGIENIC PROFILE

- Concave design, two-piece construction with corner caps at the joints.

#### LATERAL ACRISTALADO

- Doble cristal con cámara de argón sobre marco

#### GLAZED SIDE PANEL

- Double glazing with argon-filled cavity in frame.

#### ILUMINACIÓN

- Doble tira de LED, luz continua,
- Para recintos para vino o carnes, iluminación en tonalidad especial 3000K o ROSA.

#### LIGHTING

- Double LED strip, continuous light.
- For wine or meat rooms, lighting in special tones: 3000 K or pink.

#### ACCESORIOS INCLUIDOS

- Perfil sanitario postizo
- Luz interior
- 1 lateral acristalado
- Llave hexagonal con mango para montaje de las fijaciones de paneles

#### INCLUDED ACCESSORIES

- Surface-mounted hygienic profile.
- Interior light.
- 1 glazed side panel
- Hexagonal key with handle for assembling the panel fixings.



La cámara CORECO para conservación o maduración de carne está concebida para proyectos donde la cámara debe aportar presencia visual, una disposición interior robusta y posibilidades específicas para la exposición o maduración del producto. Es una solución indicada para carnicería premium, espacios gourmet, restauración y proyectos donde la carne forma parte destacada de la propuesta del establecimiento.

### Estanterías

La cámara para carne puede incorporar estanterías modulares de acero inoxidable, con estantes, barras y ganchos, concebidas para ofrecer una distribución interior ordenada, sólida y adaptable. Esta solución permite configurar el espacio interior para exposición de producto, almacenamiento organizado o apoyo a procesos de maduración, manteniendo una imagen cuidada y una operativa cómoda en el día a día.

### Iluminación

La cámara puede incorporar iluminación LED continua y, en la versión para carne, iluminación LED con tonalidad específica para realzar visualmente el producto y reforzar su presencia en exposición.

*The CORECO cold room for meat preservation or ageing has been designed for projects where the room must provide visual presence, a robust interior layout and specific possibilities for product display or ageing. It is a solution intended for premium butcher shops, gourmet spaces, foodservice and projects where meat plays a prominent role in the establishment's offering.*

### Shelving

*The meat cold room can be fitted with modular stainless steel shelving, including shelves, bars and hooks, designed to provide an orderly, solid and adaptable interior layout. This solution makes it possible to configure the interior space for product display, organised storage or support for ageing processes, while maintaining a carefully presented appearance and convenient day-to-day operation.*

### Lighting

*The cold room can incorporate continuous LED lighting and, in the meat version, LED lighting with a specific tone designed to visually enhance the product and reinforce its presence on display.*



CÁMARA CARNES - DRY AGEING ROOM						ESTANTERIA - SHELVING			COMPACTO - COMPACT	
COD	m³	F	L	H	€	LINEAL	ANGULAR 1	ANGULAR 2	MOD*	€
REDA-134174AC	3,73	1340	1730	2160	5.596 €	890x400x1670	-	-	MSF-UG-1016	4.606 €
REDA-134174CC	4,47	1340	1730	2560	6.118 €	890x400x1970	-	-	MSF-UG-1016	4.606 €
REDA-174174AC	4,99	1740	1740	2160	6.259 €	1490x400x1670	1150x400x1670	650x400x1670	MSF-UG-1016	4.606 €
REDA-174174CC	5,99	1740	1740	2560	6.850 €	1490x400x1970	1150x400x1970	650x400x1970	MSF-UG-1016	4.606 €
REDA-134294AC	6,56	1340	2940	2160	7.707 €	2025x400x1670	-	-	MSF-UG-1016	4.606 €
REDA-134294CC	7,87	1340	2940	2560	8.436 €	2025x400x1970	-	-	MSF-UG-1016	4.606 €
REDA-174294AC	8,78	1740	2940	2160	8.566 €	2725x400x1670	2680x400x1670	2080x400x1670	MSF-UG-1016	4.606 €
REDA-174294CC	10,54	1740	2940	2560	9.363 €	2725x400x1970	2680x400x1970	2080x400x1970	MSF-UG-1016	4.606 €

\* conservación, consultar maduración  
consult ageing applications

Concebida para proyectos donde la conservación y la presentación de la botella deben formar parte de una misma solución. Su planteamiento combina una imagen cuidada, una lectura visual clara del producto y una configuración interior preparada para ordenar la exposición con coherencia.

Es una solución indicada para restaurantes, vinotecas, tiendas gourmet y espacios donde el vino forma parte activa de la experiencia del cliente y de la imagen del local, convirtiendo la cámara en un elemento integrado en el espacio y no en un simple recinto técnico.

### Estanterías

La cámara para cava de vinos puede equiparse con estanterías específicas para vinoteca, ajustan al suelo y techo, concebidas para crear una exposición ordenada, estable y visualmente limpia de la botella. Su configuración interior permite transformar la cámara en un espacio de conservación con fuerte valor añadido en presentación, especialmente indicado para restauración, retail gourmet y proyectos donde el vino forma parte de la identidad del establecimiento.

### Iluminación

La cámara puede incorporar iluminación LED continua, diseñada para aportar uniformidad visual, mejorar la lectura del interior y reforzar la presencia del producto expuesto sin alterar la limpieza estética del conjunto.

*Designed for projects where bottle preservation and presentation must form part of the same solution. Its concept combines a carefully considered appearance, a clear visual presentation of the product and an interior configuration prepared to organise the display coherently.*

*It is a solution intended for restaurants, wine bars, gourmet shops and spaces where wine plays an active role in the customer experience and in the image of the establishment, turning the cold room into an integrated element of the space rather than a simple technical enclosure.*

### Shelving

*The wine cellar cold room can be fitted with specific wine display shelving, fixed between floor and ceiling, designed to create an orderly, stable and visually clean bottle display. Its interior configuration makes it possible to transform the cold room into a preservation space with strong added value in presentation, particularly suitable for foodservice, gourmet retail and projects where wine forms part of the identity of the establishment.*

### Lighting

*The cold room can incorporate continuous LED lighting, designed to provide visual uniformity, improve the view of the interior and reinforce the presence of the displayed product without altering the clean aesthetic of the overall design.*

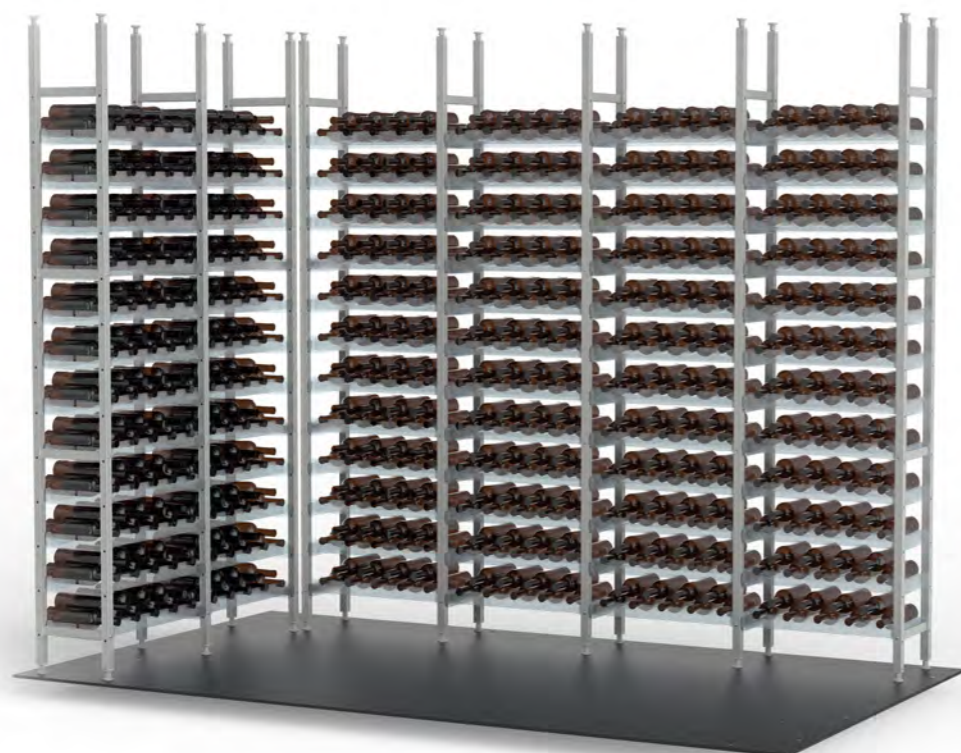

CAVA VINO - WINE CELLAR						ESTANTERIA - SHELVING			COMPACTO - COMPACT	
COD	m³	F	L	H	€	LINEAL	ANGULAR 1	ANGULAR 2	MOD	€
RECV-134174AC	3,73	1340	1730	2160	5.596 €	890x400x1670	-	-	VSF-GG-1014	7.321 €
RECV-174174AC	4,99	1740	1740	2160	6.259 €	1490x400x1670	1150x400x1670	650x400x1670	VSF-GG-1024	8.813 €
RECV-134294AC	6,56	1340	2940	2160	7.707 €	2025x400x1670	-	-	VSF-GG-1034	10.307 €
RECV-174294AC	8,78	1740	2940	2160	8.566 €	2725x400x1670	2680x400x1670	2080x400x1670	VSF-GG-1034	10.307 €

La cámara CORECO para conservación o maduración de queso está concebida para proyectos donde la cámara debe aportar presencia visual, una disposición interior funcional y una configuración específica para la exposición, conservación o maduración del producto. Es una solución indicada para tiendas gourmet, comercios especializados, restauración y proyectos donde el queso forma parte destacada de la propuesta del establecimiento.

### Estanterías

La cámara para queso puede incorporar estanterías modulares de fondo 400 mm, disponibles en alturas de 1670 y 1970 mm, concebidas para ofrecer una distribución interior ordenada, sólida y adaptable. Esta solución permite configurar el espacio interior para exposición de producto, almacenamiento organizado o apoyo a procesos de maduración, manteniendo una imagen cuidada y una operativa cómoda en el día a día.

### Iluminación

La cámara puede incorporar iluminación LED continua y, en la versión para queso, iluminación blanca de 6500 K, pensada para mejorar la visibilidad del producto y reforzar una presentación limpia, nítida y profesional en exposición.

*The CORECO cold room for cheese preservation or ageing has been designed for projects where the room must provide visual presence, a functional interior layout and a specific configuration for product display, preservation or ageing. It is a solution intended for gourmet shops, specialist retailers, foodservice and projects where cheese plays a prominent role in the establishment's offering.*

### Shelving

*The cheese cold room can be fitted with modular shelving with a depth of 400 mm, available in heights of 1670 and 1970 mm, designed to provide an orderly, solid and adaptable interior layout. This solution makes it possible to configure the interior space for product display, organised storage or support for ageing processes, while maintaining a carefully presented appearance and convenient day-to-day operation.*

### Lighting

*The cold room can incorporate continuous LED lighting and, in the cheese version, 6500 K white lighting, designed to improve product visibility and reinforce a clean, sharp and professional presentation in display applications.*



CAVA QUESO - CHEESE CELLAR						ESTANTERIA - SHELVING			COMPACTO - COMPACT	
COD	m³	F	L	H	€	LINEAL	ANGULAR 1	ANGULAR 2	MOD*	€
RECC-134174AC	3,73	1340	1730	2160	5.596 €	890x400x1670	-	-	HSF-DG-1024	6.539 €
RECC-174174AC	4,99	1740	1740	2160	6.259 €	1490x400x1670	1150x400x1670	650x400x1670	HSF-DG-1026	6.853 €
RECC-134294AC	6,56	1340	2940	2160	7.707 €	2025x400x1670	-	-	HSF-DG-1026	6.853 €
RECC-174294AC	8,78	1740	2940	2160	8.566 €	2725x400x1670	2680x400x1670	2080x400x1670	HSF-DG-1038	8.569 €

\* conservación, consultar maduración  
consult ageing applications

## PANELES

- Espesor de 100 mm
- Unión: sujeción por presión, llave incluida, fabricado en ABS de alta resistencia.
- Revestimiento estándar en acero galvanizado prelacado poliéster, con film de protección. Color blanco pirineo
- IEI: interior acero AISI-304
- EA: interior prelacado poliéster, con film de protección, color blanco pirineo

## PUERTA

- Burlete desmontable con ajuste perimetral sobre el marco, asegura la estanqueidad
- Hueco de luz de puerta 610x800, 610x2100 opcional
- Cierre palanca, opcional con llave

## AISLAMIENTO

- Espuma rígida de poliuretano, libre de CFC e inyectado a alta presión densidad 45 Kg. / m<sup>3</sup>
- Coeficiente de conductividad térmica 0.022W/mK a 10°C. (Sin envejecimiento)

## INCLUIDO

- Ruedas
- Cierre de maneta (llave opcional)

## PANELS

- 100 mm thickness
- Joint system: pressure fastening, key included, made of high-resistance ABS.
- Standard cladding in pre-lacquered polyester galvanized steel, with protective film. Pyrenees white
- EI: AISI-304 SS interior
- EA: re-lacquered polyester galvanized steel, with protective film, Pyrenees white color

## DOOR

- Removable gasket with perimeter adjustment on the frame, ensuring a tight seal.
- Clear door opening: 610x800, 610x2100 on demand
- Lever lock, optional with lock

## INSULATION

- Rigid polyurethane foam, CFC-free and high-pressure injected. Density: 45 kg/m<sup>3</sup>.
- Thermal conductivity coefficient: 0.022 W/mK at 10°C (without ageing).

## INCLUDED

- Castors.
- Lever lock (key optional)



Almacén de hielo - Ice cubes storage cabinet						Material		COMPACTO - COMPACT	
COD	m <sup>3</sup>	F	L	H	€	Exterior	Interior	MOD	€
AH-1P-EA	1,13	880	1380	2110	2.507 €	prelacado	prelacado	BCR-ND-1017A	3.148 €
AH-1P-EI	1,13	880	1380	2110	3.240 €	prelacado	AISI304	BCR-ND-1017A	3.148 €
AH-2P-EA	2,25	880	2580	2110	3.244 €	prelacado	prelacado	BCR-ND-1028A	3.448 €
AH-2P-EI	2,25	880	2580	2110	5.278 €	prelacado	AISI-304	BCR-ND-1028A	3.448 €

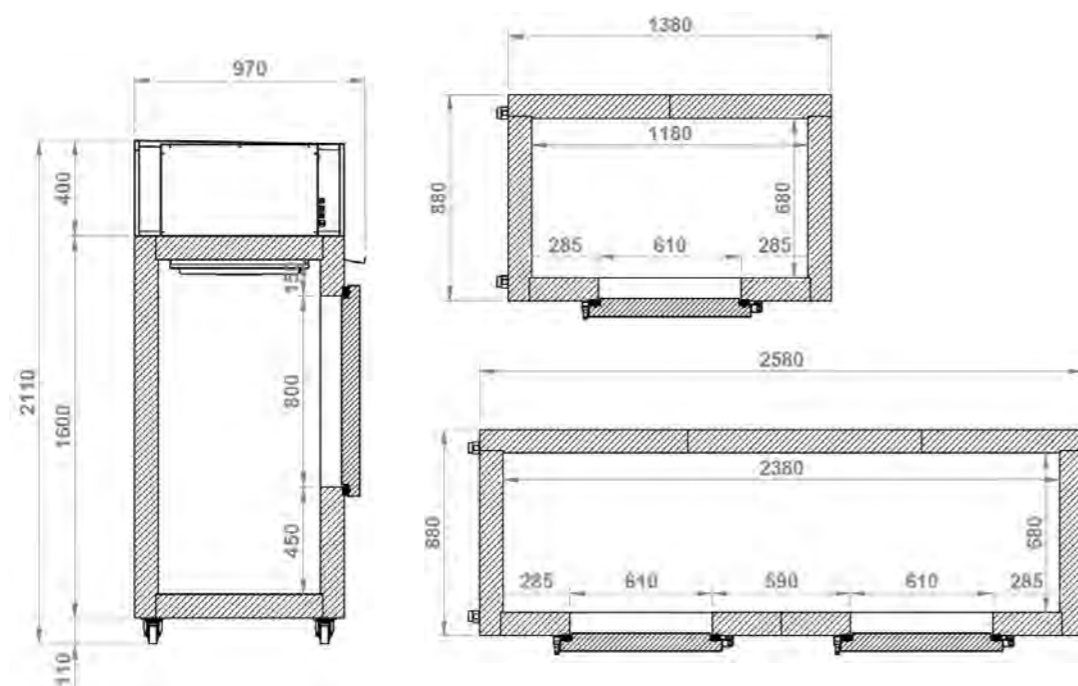

504



505



**ESTANTERÍAS Y CORTINAS**  
*PVC CURTAINS AND SHELVING*



506



507

Las cortinas de lamas están formadas por láminas de PVC flexible y transparente solapadas entre si.

*The PVC curtains are formed by flexible and transparent PVC sheets joined together.*

Herrajes fabricados en acero inoxidable aptas el sector del frio industrial.

*All fittings and screws are made in stainless Steel and suitable for the industrial refrigeration.*

El uso de lamas de PVC flexible es muy útil en puertas frigoríficas para reducir el porcentaje de pérdidas de energía a la hora de cargar y descargar mercancías.

*The use of flexible PVC are very useful for refrigerating doors. They reduced the lost of energy when you uoload and download the products*

La fijación del soporte de lamas puede situarse tanto en el panel puerta como en el techo de la cámara.

*The fixing of the PVC curtains support can be placed weather in the panel of the door or in the ceiling of the cold room.*

Todas las lamas de PVC flexible, pueden ser utilizadas en salas donde se almacenan, preparan, elaboran, etc... los alimentos, incluidos los almacenes donde se cargan las mercancías.

*All the PVC curtains, can be use in rooms where they can elaborate foods, as well as in warehouses where goods are loaded.*

Con un sistema de montaje fácil y sencillo, permite la colocación y sustitución de las lamas de forma rápida y cómoda. Se suministrarán tornillos autorroscantes de acero inoxidable.

*Whith an easy assembly system, it allows the place and replacement of the in an easily and comfortable way. It is supplied with stainless sets self-tapping screws.*

PROPIEDADES PROPERTIES	NORMA TEST METHOD	UNIDAD UNIT	REFRIGERACIÓN CHILLER	CONGELACIÓN FREEZER
<b>Dureza</b> Shore "A" Hardnes	DIN53 505	-	75	65
<b>Densidad específica</b> Specific Density	DIN 53 479	g/cm3	1.22	1.2
<b>Temperatura de servicio</b> Temperature Resistance	-	ºC	+50/-20	+35/-40
<b>Flexibilidad</b> Flexibility	-	ºC	-35	-40
<b>Temperatura de rotura al frío</b> Cold Bend Brittle Point	DIN 53 372	ºC	-35	-45
<b>Elongación de rotura</b> Elongation at Break	DIN 53 455	%	360	400
<b>Resistencia a la rotura</b> Tensile Strength	DIN 53 455	n/mm2	17	13
<b>Absorción de agua</b> Water Absorption	DIN 53 472	Mg	17	21
<b>Transparencia</b> Light Transmittance	ASTM D 1003	%	>80	>75
<b>Protección acústica</b> Sound Protection	DIN 52 210	dB	>35	>35
<b>Inflamabilidad / Resistencia al Fuego</b> Flammability/Reaction to Fire	DIN 53 382	-	Autoextinguibles Self extinguishing	

TODAS NUESTRAS LAMAS RESISTEN LOS RAYOS UV



	Dimensiones luz puerta Door opening			
	alto height mm	ancho width mm	€	
refrigeración - chiller	CLR060-185	1850	600	170 €
	CLR070-185	1850	700	197 €
	CLR080-185	1850	800	229 €
	CLR090-185	1850	900	256 €
	CLR0100-185	1850	1000	289 €
	CLR0120-185	1850	1200	341 €
	CLR0140-185	1850	1400	400 €
	CLR0160-185	1850	1600	460 €
	CLR0180-185	1850	1800	518 €
	CLR0200-185	1850	2000	572 €
congelados - freezer	CLC060-200	2000	600	179 €
	CLC070-200	2000	700	210 €
	CLC080-200	2000	800	236 €
	CLC090-200	2000	900	269 €
	CLC0100-200	2000	1000	301 €
	CLC0120-200	2000	1200	362 €
	CLC0140-200	2000	1400	420 €
	CLC0160-200	2000	1600	478 €
	CLC0180-200	2000	1800	538 €
	CLC0200-200	2000	2000	597 €
refrigeración - chiller	CLC060-185	1850	600	216 €
	CLC070-185	1850	700	256 €
	CLC080-185	1850	800	289 €
	CLC090-185	1850	900	329 €
	CLC0100-185	1850	1000	362 €
	CLC0120-185	1850	1200	432 €
	CLC0140-185	1850	1400	512 €
	CLC0160-185	1850	1600	585 €
	CLC0180-185	1850	1800	656 €
	CLC0200-185	1850	2000	729 €
congelados - freezer	CLC060-200	2000	600	229 €
	CLC070-200	2000	700	269 €
	CLC080-200	2000	800	309 €
	CLC090-200	2000	900	347 €
	CLC0100-200	2000	1000	381 €
	CLC0120-200	2000	1200	460 €
	CLC0140-200	2000	1400	538 €
	CLC0160-200	2000	1600	610 €
	CLC0180-200	2000	1800	690 €
	CLC0200-200	2000	2000	769 €

Fabricamos Cortinas de Lamas para cualquier dimensión de puerta.

*We are the manufacturers of the PVC curtains, and can supply curtains for any door sizes.*

Consultar con nuestro departamento comercial.

*Contact our sales team for a quote.*



CORECO le presenta su nueva gama de ESTANTERÍAS MODULARES realizadas con una estructura de aluminio anodizado y parrillas de polietileno, aptas para el uso con productos alimentarios.

Con nuestras Estanterías y sus múltiples combinaciones conseguiremos una óptima eficiencia en la organización y almacenaje de su cocina industrial.

Además, los materiales empleados en su construcción, la hacen especialmente adecuadas para su uso en cámaras frigoríficas.

CORECO presents its new range of MODULAR SHELVING UNITS made with an anodized aluminium structure and polyethylene wire shelves, suitable for food storage.

Our Shelving Units and their multiple combinations will enable you to efficiently store and organise your industrial kitchen.

Additionally, the materials used to build the units make them especially durable for use in cold room.

**Características técnicas:**

- Especialmente diseñadas para uso alimentario.
- Estructura de aluminio anodizado que proporciona gran rigidez al conjunto.
- Parrillas fabricadas en polietileno calidad alimentaria.
- Tornillería utilizada en su construcción de acero inoxidable.
- Máxima modularidad que la hace adaptable a todos los espacios.
- Dos Fondos de estantes, 400 ó 500 mm.
- Tres alturas, con estantes regulables cada 150 mm.
- También recomendadas para el uso en cámaras frigoríficas, tanto para temperaturas positivas como negativas.
- No se necesita ningún tipo de herramientas para su montaje.

**Technical specifications:**

- Specifically designed for use with food products.
- Strong anodized aluminium structure.
- Wire shelves are made of food grade polyethylene.
- Assembled using stainless steel screws.
- Maximum modularity making the units adaptable to all spaces.
- Two shelf depths, 400 or 500mm.
- Three heights, with adjustable shelves every 150mm.
- Also recommended for use in cold rooms, for both plus and minus temperatures.
- No tools are needed for assembly.

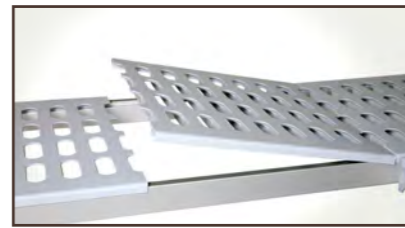

**Parrillas:** Fácil montaje y desmontaje. Máxima higiene. Las parrillas se pueden lavar en lavavajillas convencional.

*Wire shelves: Easy assembly and disassembly. Maximum hygiene. Wire shelves can be washed in a conventional dishwasher.*



**Soportes ángulo:** Posibilitan el montaje en ángulo de la estantería otorgándole gran modularidad.  
*Angle brackets: Make it possible to mount shelving units at an angle providing a high amount of flexibility.*



**Montaje:** Fácil montaje. Todas las piezas encajan a la perfección sin necesidad de herramientas.  
*Assembly: Easy assembly. All pieces fit together perfectly without the need for tools.*

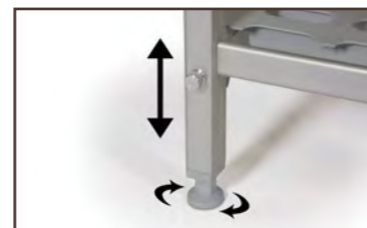

**Pies:** Con regulación en altura para salvar posibles desniveles del suelo.  
*Feet: Adjustable feet for uneven floors.*

**MODULARIDAD TOTAL:**

La gran modularidad de la estantería le permite combinar diferentes dimensiones y formas para así adaptarse al espacio disponible de su recinto.

Personalice su estantería agregando, si lo requiere, mas niveles de estantes a los suministrados de manera estándar.

La combinación de medidas y formas diferentes dan como resultado una óptima organización de su area de trabajo y/o almacenaje.

A partir de la estantería de que disponga, puede llegar a configurar tantas combinaciones como requiera.



**COMPLETE FLEXIBILITY:**

The enhanced flexibility of the shelving units allows you to combine different sizes and shapes to adapt to the space available in your room.

If required, you can customise your product by adding extra shelves to the standard model.

The combination of different shapes and sizes results in optimal organisation of your work area and/or storage.

From the shelving units available you can configure as many combinations as required.



**CAPACIDAD Y RESISTENCIA:**

En estantes de hasta 1 metro de longitud, puede almacenar hasta 120 Kgrs. de peso repartidos de forma uniforme.

A partir de 1 metro de longitud la carga admisible repartida uniformemente pasa a ser de 100 Kgrs.

**CAPACITY AND RESISTANCE:**

Shelves up to one metre in length can store a maximum of 120kg of evenly distributed weight.

Shelves over one metre in length can withstand a maximum of 100kg of evenly distributed weight.

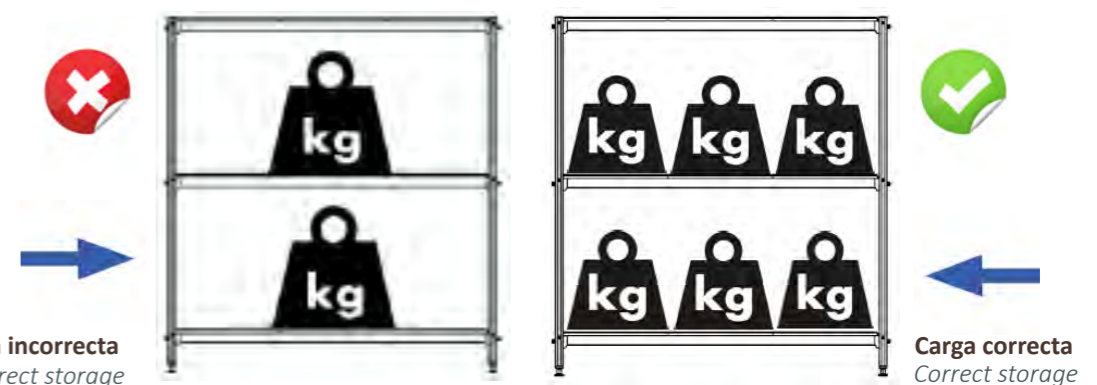



## ESTANTERÍA LINEAL. ( L )

La Estantería LINEAL es una estantería individual con escaleras soportes en cada extremo. Esta estantería permite, además de su montaje independiente, múltiples combinaciones mediante la colocación de estanterías complementarias y/o angulares por ambos lados.

### LINEAR SHELVING UNITS. ( L )

LINEAR Shelving Units are individual units supported by uprights at each end.

This shelving unit allows, in addition to independent assembly, multiple shelving combinations by adding supplementary shelving units and/or angular shelving units on both sides.



## ESTANTERÍA COMPLEMENTARIA. ( C )

La Estantería COMPLEMENTARIA es una estantería individual con escaleras soportes en SÓLO uno de sus extremos, ya que el otro se une a la escalera de la estantería a la que complementa. La estantería complementaria puede complementar a una estantería Lineal, a otra Complementaria o a una Angular.

### SUPPLEMENTARY SHELVING UNITS. ( C )

SUPPLEMENTARY Shelving Units are individual units supported by uprights on ONLY one end as the other end connects to the additional shelving unit.

Supplementary shelving can be added to Linear shelving units, other Supplementary shelving or to Angular shelving units.



## ESTANTERÍA ANGULAR. ( A )

La estantería ANGULAR es una estantería individual con escaleras soportes en SÓLO uno de sus extremos. La sujeción del extremo que no tiene escalera se realiza mediante unos soportes de acero inoxidable que facilitan su montaje en ángulo. Estos soportes van incluidos cuando se pide una estantería angular.

### ANGULAR SHELVING UNITS. ( A )

ANGULAR Shelving Units are individual units supported by uprights on ONLY one side. On the side without uprights, the stainless steel brackets which support the unit are assembled at an angle. These brackets are included when an angular shelving unit is ordered.

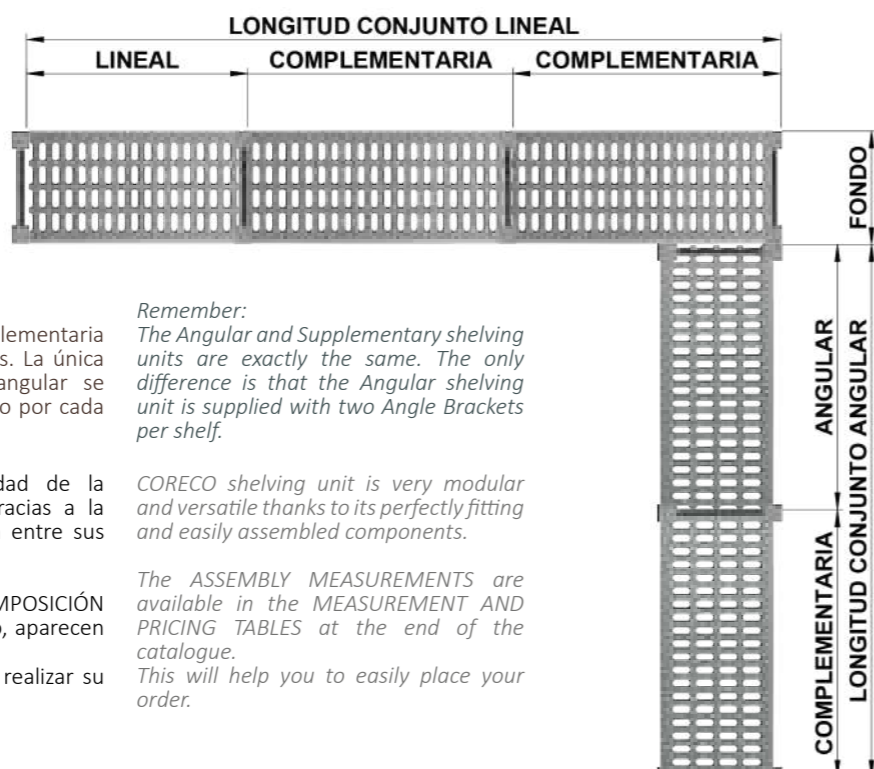

#### Recuerde:

La estantería Angular y la Complementaria son estanterías exactamente iguales. La única diferencia es que la estantería angular se suministra con dos Soportes Ángulo por cada nivel.

La gran modularidad y versatilidad de la Estantería CORECO se consigue gracias a la perfecta unión y fácil combinación entre sus elementos.

En las TABLAS DE VALORACIÓN Y COMPOSICIÓN DE CONJUNTOS, al final de catálogo, aparecen las LONGITUDES DE CONJUNTO. Esto le servirá de gran ayuda para realizar su pedido fácilmente.

#### Remember:

The Angular and Supplementary shelving units are exactly the same. The only difference is that the Angular shelving unit is supplied with two Angle Brackets per shelf.

CORECO shelving unit is very modular and versatile thanks to its perfectly fitting and easily assembled components.

The ASSEMBLY MEASUREMENTS are available in the MEASUREMENT AND PRICING TABLES at the end of the catalogue. This will help you to easily place your order.

#### Recuerde:

Si se requieren mas niveles de estantes de los suministrados de manera estándar, sumar al valor de la estantería el valor del estante correspondiente que aparece en el apartado: COMPONENTES DE LA ESTANTERÍAS.

#### Remember:

If you need more shelves than the amount supplied with the standard product, add the price of the extra shelf or shelving unit to the corresponding price of the unit listed in this section SHELVING UNIT COMPONENTS.

**ALTURA 1370 mm.**  
**FONDO 400 o 500 mm.**  
**3 o 4 NIVELES**

HEIGHT 1370mm  
DEPTH 400 or 500mm  
3 or 4 SHELVES

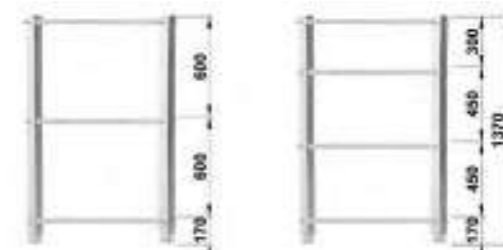

**ALTURA 1670 mm.**  
**FONDO 400 Ó 500 mm.**  
**3 ó 4 NIVELES**

HEIGHT 1670mm  
DEPTH 400 or 500mm  
3 or 4 SHELVES

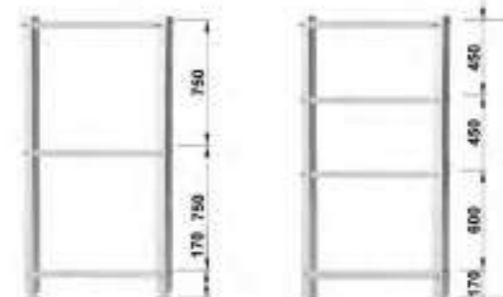

Separación mínima  
150 mm

150 mm  
min. distance

**ALTURA 1970 mm.**  
**FONDO 400 o 500 mm.**  
**3,4 o 5 NIVELES**

HEIGHT 1970mm  
DEPTH 400 or 500mm  
3, 4 or 5 SHELVES



## LONGITUD DE ESTANTERÍAS LINEALES INDIVIDUALES. COMPOSICIÓN DE ESTANTES.

LENGTH OF INDIVIDUAL LINEAR SHELVING UNITS. SHELF ASSEMBLY.

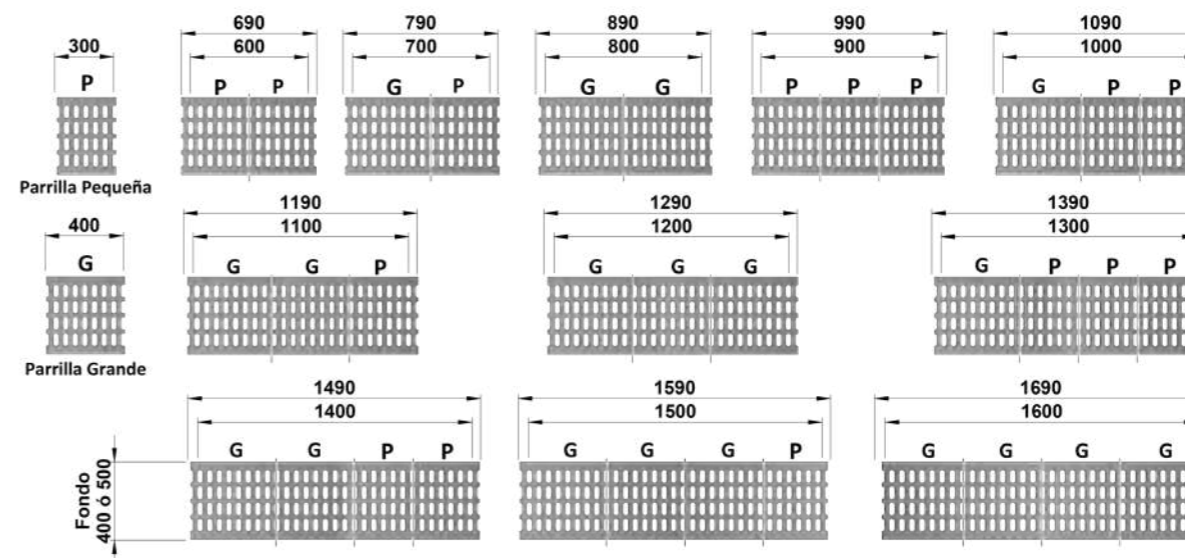



### SOPORTES ESCALERAS:

Resistentes y fabricados en aluminio anodizado. De manera estándar se suministran en tres alturas diferentes y para dos fondos, 400 ó 500 mm. En función de su altura se pueden elegir con 3, 4 ó 5 niveles de estantes. Disponen de patas regulables y en todos los casos permiten la regulación de los estantes cada **150 mm**. Los Soportes Escaleras se sirven completos, con todos los elementos necesarios para montar los estantes.

### SUPPORTING BRACKETS:

Hard-wearing anodised aluminium. The standard product includes three different heights and two depths of 400 or 500mm. Depending on their height, they can be ordered with 3, 4 or 5 individual shelves. They have adjustable feet which allow shelves to be adjusted every 150mm. Supporting uprights are provided with all the necessary components to assemble the shelves.

FONDO 400 / DEPTH 400				FONDO 500 / DEPTH 500			
ALTURA HEIGHT	MODELO MODEL	NIVELES SHELVES	€	ALTURA HEIGHT	MODELO MODEL	NIVELES SHELVES	€
1370	E137F4-3N	3	76 €	1370	E137F5-3N	3	78 €
1370	E137F4-4N	4	84 €	1370	E137F5-4N	4	85 €
1670	E167F4-3N	3	83 €	1670	E167F5-3N	3	84 €
1670	E167F4-4N	4	92 €	1670	E167F5-4N	4	94 €
1970	E197F4-3N	3	100 €	1970	E197F5-3N	3	105 €
1970	E197F4-4N	4	109 €	1970	E197F5-4N	4	113 €
1970	E197F4-5N	5	117 €	1970	E197F5-5N	5	122 €

### Recuerde:

Más niveles de estantes bajo pedido. No olvide pedir los pasadores o soportes angulares necesarios.

### Remember:

More shelves are available on request. Do not forget to ask for the necessary bolts or angular brackets.

### KIT ESTANTES:

Los Estantes forman los distintos niveles de la estantería. Si necesita incorporar más niveles a su estantería, nos puede solicitar estantes sueltos. En ese caso no olvide agregar a su pedido los pasadores y soportes ángulo necesarios.

FONDO 400 / DEPTH 400			FONDO 500 / DEPTH 500		
LONGITUD LENGTH	MODELO MODEL	€	LONGITUD LENGTH	MODELO MODEL	€
600	ES600F4	38 €	600	ES600F5	43 €
700	ES700F4	43 €	700	ES700F5	49 €
800	ES800F4	47 €	800	ES800F5	53 €
900	ES900F4	53 €	900	ES900F5	59 €
1000	ES1000F4	58 €	1000	ES1000F5	64 €
1100	ES1100F4	61 €	1100	ES1100F5	68 €
1200	ES1200F4	63 €	1200	ES1200F5	74 €
1300	ES1300F4	66 €	1300	ES1300F5	75 €
1400	ES1400F4	75 €	1400	ES1400F5	81 €
1500	ES1500F4	76 €	1500	ES1500F5	84 €
1600	ES1600F4	78 €	1600	ES1600F5	85 €

### PASADORES:

Juego de pasadores (macho + hembra). Fabricados en aluminio, van incorporados a la escalera en función al número de niveles que solicite en su pedido. Son elementos necesarios para poder ampliar el número de estantes de su estantería.

### BOLTS:

Set of bolts (male + female). The supporting uprights are put together with aluminium bolts, according to the number of shelves ordered. They are necessary to be able to increase the number of shelves in your shelving unit.

MODELO MODEL	€/ UD. € per U	DOTACIÓN NECESARIA POR ESTANTE EQUIPMENT NEEDED FOR SHELVES
PA	6 €	4 uds. por estante en estantería LINEAL y/o COMPLEMENTARIA 4 units per shelf in the LINEAR and/or SUPPLEMENTARY shelving units
		2 uds. por estante en estantería ANGULAR 2 units per shelf in the ANGULAR shelving



### SOPORTES ÁNGULO:

Posibilitan el montaje de la estantería en un ángulo de 90°, dotando a la estantería de una gran modularidad.

### ANGLE BRACKETS:

These allow the shelving units to be mounted at a 90° angle, making the unit very flexible.

MODELO MODEL	€/ UD. € per U	DOTACIÓN NECESARIA POR ESTANTE EQUIPMENT NEEDED FOR SHELVES
SA	10 €	2 uds. por estante en estantería ANGULAR 2 units per shelf in the ANGULAR shelving



1370 1670 1970

### SHELVES KIT:

Shelves form the different levels of the shelving units. If you need to add more shelves to your shelving unit, you can request individual shelves. In that case, don't forget to add the necessary bolts and angle brackets to your order.



### De serie:

- 1 estante base fijo de carga fijo.
- 4 estantes de carga móviles 600x665 regulables en altura (paso 80mm), inclinación (0°, 8° y 16°) y profundidad.
- Barandilla frontal de alambre plastificado blanco.
- Portaprecios.

### Opción:

- Separador lateral blanco o cromado
- Barandilla frontal cromada o metacrilato



ME2P600

módulo estantería shelves module	mod.	fondo depth	puertas doors	€
		mm	uds	
	ME1P600	600	1	1.144 €
	ME2P600	600	2	2.183 €
	ME3P600	600	3	3.202 €
	ME4P600	600	4	4.315 €
	ME5P600	600	5	5.390 €

### Standar:

- 1 loading level fixed
- 4 moving shelves of loading 600x665 adjustable on height (space 80mm), inclination (0°, 8° y 16°) and depth.
- Front railing in white coating wire
- Price tag

### Optional:

- White or Chromed Side separator
- Chromed or Methacrylate front railing

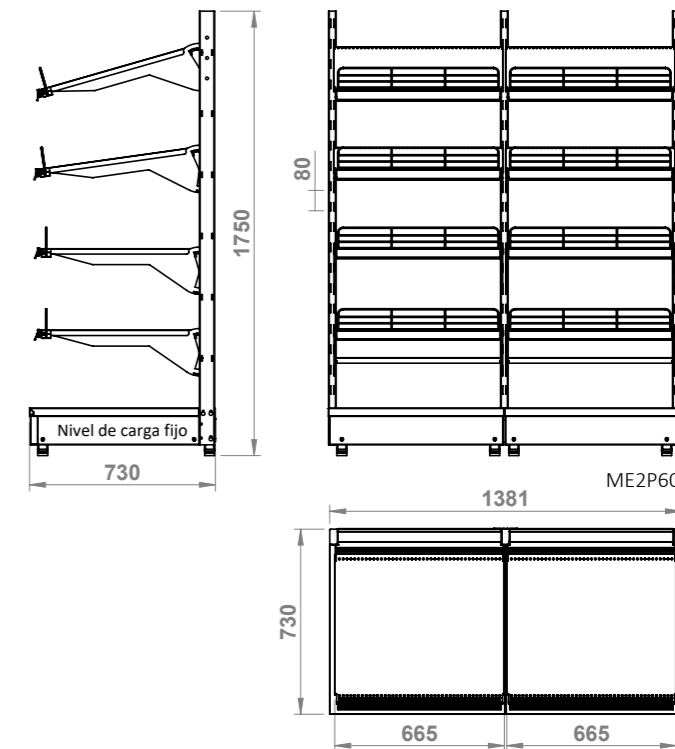

AFD-PC



RFM-PC

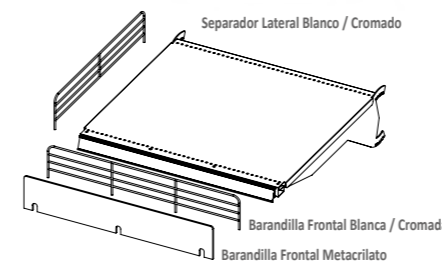

Separador Lateral Blanco / Cromado  
Barandilla Frontal Blanca / Cromada  
Barandilla Frontal Metacrilato

Opcional Optional	€
separador lateral cromado chromed lateral divider	37 €
barandilla frontal metacrilato plexy front railing	37 €
barandilla frontal cromada chromed front railing	37 €



• Separación lateral, cada 1 cm. • Lateral separation, every 1 cm.



Para su comodidad en las **Tablas de Valoración y Composición de Conjuntos**, al final de este apartado, tiene ya calculados los conjuntos para cada longitud.

Usted solo ha de elegir el fondo de estante deseado, la altura de la estantería y el número de niveles de estantes.

Una vez elegido tome nota del Código de Artículo y háganos llegar su pedido.

*For your convenience the length of each unit has been calculated in the Measurement and Pricing tables at the end of this catalogue. You only have to choose the shelf depth, the shelving unit height and the numbers of shelves you want. Once you have chosen, note down the product code and send us your order.*

### Ejemplo para colocar estanterías en forma de 'L' en un recinto de dimensiones 4000 x 3000 mm.

Para el ejemplo tomamos como base una estantería de altura 1670 mm, fondo 400 mm y 4 niveles de estantes.

1. Para la pared de 4000 mm de nuestro recinto consultaremos en la Tabla de Valoración y Composición de Conjuntos la estantería lineal de longitud inmediatamente inferior a los 4000 mm. Buscando en la tabla **Estantería lineal de fondo 400 mm. altura 1670 mm y 4 niveles** encontramos una estantería con longitud 3960 mm. (Cód. de artículo L214).

2. En la siguiente pared de 3000 mm. queremos colocar otra estantería.

En este caso elegiremos una estantería angular.

La longitud de la misma será 3000 mm. que es la dimensión de la pared menos el fondo de la estantería que hemos colocado anteriormente. En nuestro ejemplo es 400 mm.

Buscaremos en la tabla **Estantería angular de fondo 400 mm. y altura 1670 mm y 4 niveles** y encontraremos una estantería de longitud 2580 mm. (Cód. de artículo A201).

Si quisieramos colocar otra estantería en la segunda pared de 4000 mm. solo tendríamos que repetir el paso 2.

*Example of how to build an L shaped shelving unit in a 4000x3000mm room.*

*For this we would choose a shelving unit measuring 1670mm height, a 400mm depth and 4 shelves.*

*1. For a wall measuring 4000 mm, we would consult the Measurement and Pricing tables for a shelving unit measuring less than 4000mm in length.*

*Searching in the table for a Linear Shelving Unit with a depth of 400mm, a height of 1670 mm and 4 shelves, we find a shelving unit measuring 3960mm in length. (Product code L214).*

*2. On the other wall measuring 3000mm, we want to assemble another shelving unit.*

*In this case we choose an angular shelving unit.*

*The length of the unit will measure 3000mm, equalling the length of the wall, minus the depth of the other shelving unit we have already assembled. In our example it measures 400mm.*

*Searching in the table for an Angular Shelving Unit with a depth of 400mm, a height of 1670 mm and 4 shelves, we find a shelving unit measuring 2580mm in length. (Product code A201).*

*If we wanted to put another shelving unit on the second wall measuring 4000mm, we would just repeat step 2.*

#### Recuerde:

Para elegir su estantería LINEAL vaya a las tablas de valoraciones de Estantería Lineal y elija la que mejor se adapte a la longitud de su recinto.

Para elegir su estantería ANGULAR vaya a las tablas de valoraciones de Estantería Angular y elija la que mejor se adapte a su recinto.

En este caso **NO OLVIDE** descontar a las dimensiones de su recinto el **FONDO** que haya elegido para su estantería lineal.

#### Remember:

To choose your LINEAR shelving unit check the measurement and pricing table for Linear Shelving Units and choose the one that best suits the length of your room.

To choose your ANGULAR shelving unit check the measurement and pricing table for Angular Shelving Units and

choose the one that best suits your room.

**DO NOT FORGET** to subtract from the room measurements the **DEPTH** of the linear shelving unit you choose.

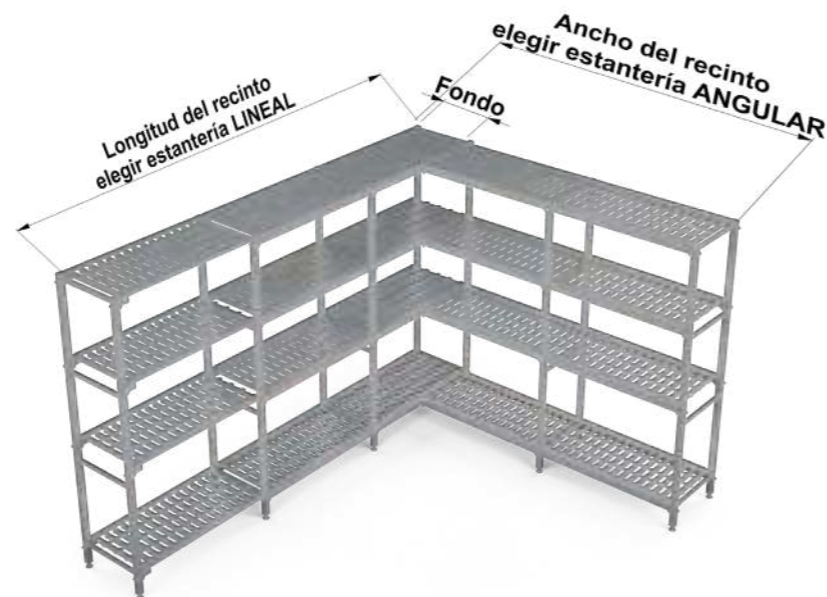

### BANCADAS:

Diseñadas para almacenar cajas en recintos frigoríficos y lugares donde se debe cumplir las normativas higiénicas. Fabricadas con los mismos materiales que el resto de las estanterías. Gran capacidad de carga hasta 150 Kgrs. Altura de la base de la bancada al suelo 250 mm.

### BENCHES:

Our benches are made from the same material as our shelving units, designed to store boxes in cold rooms and places where hygiene regulations must be complied with. Benches can store a load capacity of up to 150kg. The top of the bench measures 250mm from the ground.

#### FONDO 400 / DEPTH 400

MEDIDAS / DIMENSIONS	MODELO / MODEL	€
690x250x <b>400</b>	B600F4	136 €
790x250x <b>400</b>	B700F4	144 €
890x250x <b>400</b>	B800F4	155 €
990x250x <b>400</b>	B900F4	161 €
1090x250x <b>400</b>	B1000F4	165 €
1190x250x <b>400</b>	B1100F4	169 €
1290x250x <b>400</b>	B1200F4	174 €
1390x250x <b>400</b>	B1300F4	182 €
1490x250x <b>400</b>	B1400F4	192 €
1590x250x <b>400</b>	B1500F4	193 €
1690x250x <b>400</b>	B1600F4	199 €

#### FONDO 500 / DEPTH 500

MEDIDAS / DIMENSIONS	MODELO / MODEL	€
690x250x <b>500</b>	B600F5	147 €
790x250x <b>500</b>	B700F5	152 €
890x250x <b>500</b>	B800F5	165 €
990x250x <b>500</b>	B900F5	171 €
1090x250x <b>500</b>	B1000F5	176 €
1190x250x <b>500</b>	B1100F5	182 €
1290x250x <b>500</b>	B1200F5	185 €
1390x250x <b>500</b>	B1300F5	189 €
1490x250x <b>500</b>	B1400F5	204 €
1590x250x <b>500</b>	B1500F5	204 €
1690x250x <b>500</b>	B1600F5	207 €

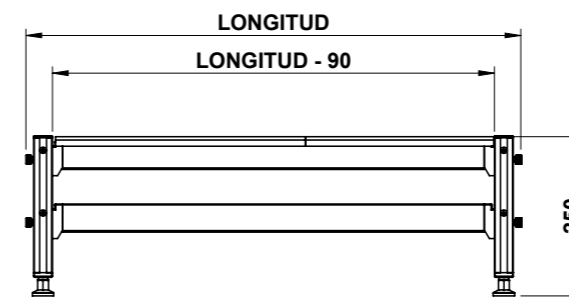

### CONFIGURADOR WEB

El configurador de estanterías para recintos frigoríficos te permite definir una solución ajustada a las dimensiones y exigencias de cada instalación. Configura la composición, el número de niveles y la distribución más adecuada para optimizar el espacio interior, ordenar el almacenamiento y responder con mayor precisión a la operativa del recinto.

### WEB CONFIGURATOR

The shelving configurator for cold rooms allows you to define a solution tailored to the dimensions and requirements of each installation. Configure the layout, number of levels and most suitable arrangement to optimise the internal space, organise storage and respond more precisely to the operational needs of the cold room.



CONFIGURE STANDARD ROOM



CONFIGURE SLINE ROOM



fondo mm depth mm	alto mm height mm	largo mm length mm	disposición de estantes shelf layout	escaleras uprights	3 niveles - 3 levels ref. €	4 niveles - 4 levels ref. €	5 niveles - 5 levels ref. €
400	1370	690	600	2	L600-4P3 228 €	L600-4P4 262 €	
400	1370	790	700	2	L700-4P3 240 €	L700-4P4 278 €	
400	1370	890	800	2	L800-4P3 252 €	L800-4P4 294 €	
400	1370	990	900	2	L900-4P3 261 €	L900-4P4 305 €	
400	1370	1090	1000	2	L1000-4P3 273 €	L1000-4P4 321 €	
400	1370	1190	1100	2	L1100-4P3 288 €	L1100-4P4 341 €	
400	1370	1290	1200	2	L1200-4P3 299 €	L1200-4P4 357 €	
400	1370	1390	1300	2	L1300-4P3 311 €	L1300-4P4 373 €	
400	1370	1490	1400	2	L1400-4P3 320 €	L1400-4P4 385 €	
400	1370	1590	1500	2	L1500-4P3 332 €	L1500-4P4 400 €	
400	1370	1690	1600	2	L1600-4P3 344 €	L1600-4P4 416 €	
400	1670	690	600	2	L600-4M3 256 €	L600-4M4 290 €	
400	1670	790	700	2	L700-4M3 268 €	L700-4M4 305 €	
400	1670	890	800	2	L800-4M3 280 €	L800-4M4 321 €	
400	1670	990	900	2	L900-4M3 289 €	L900-4M4 333 €	
400	1670	1090	1000	2	L1000-4M3 300 €	L1000-4M4 349 €	
400	1670	1190	1100	2	L1100-4M3 315 €	L1100-4M4 369 €	
400	1670	1290	1200	2	L1200-4M3 327 €	L1200-4M4 385 €	
400	1670	1390	1300	2	L1300-4M3 339 €	L1300-4M4 400 €	
400	1670	1490	1400	2	L1400-4M3 348 €	L1400-4M4 412 €	
400	1670	1590	1500	2	L1500-4M3 360 €	L1500-4M4 428 €	
400	1670	1690	1600	2	L1600-4M3 372 €	L1600-4M4 444 €	
400	1970	690	600	2	L600-4G3 284 €	L600-4G4 317 €	L600-4G5 351 €
400	1970	790	700	2	L700-4G3 296 €	L700-4G4 333 €	L700-4G5 371 €
400	1970	890	800	2	L800-4G3 307 €	L800-4G4 349 €	L800-4G5 391 €
400	1970	990	900	2	L900-4G3 316 €	L900-4G4 361 €	L900-4G5 405 €
400	1970	1090	1000	2	L1000-4G3 328 €	L1000-4G4 377 €	L1000-4G5 425 €
400	1970	1190	1100	2	L1100-4G3 343 €	L1100-4G4 396 €	L1100-4G5 450 €
400	1970	1290	1200	2	L1200-4G3 355 €	L1200-4G4 412 €	L1200-4G5 470 €
400	1970	1390	1300	2	L1300-4G3 367 €	L1300-4G4 428 €	L1300-4G5 490 €
400	1970	1490	1400	2	L1400-4G3 376 €	L1400-4G4 440 €	L1400-4G5 504 €
400	1970	1590	1500	2	L1500-4G3 388 €	L1500-4G4 456 €	L1500-4G5 524 €
400	1970	1690	1600	2	L1600-4G3 399 €	L1600-4G4 472 €	L1600-4G5 544 €
500	1370	690	600	2	L600-5P3 236 €	L600-5P4 274 €	
500	1370	790	700	2	L700-5P3 251 €	L700-5P4 294 €	
500	1370	890	800	2	L800-5P3 263 €	L800-5P4 309 €	
500	1370	990	900	2	L900-5P3 281 €	L900-5P4 333 €	
500	1370	1090	1000	2	L1000-5P3 293 €	L1000-5P4 349 €	
500	1370	1190	1100	2	L1100-5P3 304 €	L1100-5P4 365 €	
500	1370	1290	1200	2	L1200-5P3 319 €	L1200-5P4 385 €	
500	1370	1390	1300	2	L1300-5P3 334 €	L1300-5P4 404 €	
500	1370	1490	1400	2	L1400-5P3 346 €	L1400-5P4 420 €	
500	1370	1590	1500	2	L1500-5P3 358 €	L1500-5P4 436 €	
500	1370	1690	1600	2	L1600-5P3 370 €	L1600-5P4 452 €	
500	1670	690	600	2	L600-5M3 270 €	L600-5M4 307 €	
500	1670	790	700	2	L700-5M3 285 €	L700-5M4 327 €	
500	1670	890	800	2	L800-5M3 297 €	L800-5M4 343 €	
500	1670	990	900	2	L900-5M3 314 €	L900-5M4 367 €	
500	1670	1090	1000	2	L1000-5M3 326 €	L1000-5M4 383 €	
500	1670	1190	1100	2	L1100-5M3 338 €	L1100-5M4 398 €	
500	1670	1290	1200	2	L1200-5M3 353 €	L1200-5M4 418 €	
500	1670	1390	1300	2	L1300-5M3 368 €	L1300-5M4 438 €	
500	1670	1490	1400	2	L1400-5M3 380 €	L1400-5M4 454 €	
500	1670	1590	1500	2	L1500-5M3 392 €	L1500-5M4 470 €	
500	1670	1690	1600	2	L1600-5M3 403 €	L1600-5M4 486 €	
500	1970	690	600	2	L600-5G3 303 €	L600-5G4 341 €	L600-5G5 379 €
500	1970	790	700	2	L700-5G3 318 €	L700-5G4 361 €	L700-5G5 403 €
500	1970	890	800	2	L800-5G3 330 €	L800-5G4 377 €	L800-5G5 423 €
500	1970	990	900	2	L900-5G3 348 €	L900-5G4 400 €	L900-5G5 453 €
500	1970	1090	1000	2	L1000-5G3 360 €	L1000-5G4 416 €	L1000-5G5 473 €
500	1970	1190	1100	2	L1100-5G3 372 €	L1100-5G4 432 €	L1100-5G5 493 €
500	1970	1290	1200	2	L1200-5G3 387 €	L1200-5G4 452 €	L1200-5G5 517 €
500	1970	1390	1300	2	L1300-5G3 401 €	L1300-5G4 472 €	L1300-5G5 542 €
500	1970	1490	1400	2	L1400-5G3 413 €	L1400-5G4 488 €	L1400-5G5 562 €
500	1970	1590	1500	2	L1500-5G3 425 €	L1500-5G4 503 €	L1500-5G5 582 €
500	1970	1690	1600	2	L1600-5G3 437 €	L1600-5G4 519 €	L1600-5G5 601 €

fondo mm depth mm	alto mm height mm	largo mm length mm	disposición de estantes shelf layout	escaleras uprights	3 niveles - 3 levels ref. €	4 niveles - 4 levels ref. €	5 niveles - 5 levels ref. €
400	1370	650	600	1	A600-4P3 203 €	A600-4P4 250 €	
400	1370	750	700	1	A700-4P3 215 €	A700-4P4 266 €	
400	1370	850	800	1	A800-4P3 227 €	A800-4P4 282 €	
400	1370	950	900	1	A900-4P3 236 €	A900-4P4 294 €	
400	1370	1050	1000	1	A1000-4P3 248 €	A1000-4P4 309 €	
400	1370	1150	1100	1	A1100-4P3 263 €	A1100-4P4 329 €	
400	1370	1250	1200	1	A1200-4P3 275 €	A1200-4P4 345 €	
400	1370	1350	1300	1	A1300-4P3 287 €	A1300-4P4 357 €	
400	1370	1450	1400	1	A1400-4P3 296 €	A1400-4P4 373 €	
400	1370	1550	1500	1	A1500-4P3 307 €	A1500-4P4 389 €	
400	1370	1650	1600	1	A1600-4P3 319 €	A1600-4P4 404 €	
400	1670	650	600	1	A600-4M3 217 €	A600-4M4 264 €	
400	1670	750	700	1	A700-4M3 229 €	A700-4M4 280 €	
400	1670	850	800	1	A800-4M3 241 €	A800-4M4 296 €	
400	1670	950	900	1	A900-4M3 250 €	A900-4M4 307 €	
400	1670	1050	1000	1	A1000-4M3 262 €	A1000-4M4 323 €	
400	1670	1150	1100	1	A1100-4M3 277 €	A1100-4M4 343 €	
400	1670	1250	1200	1	A1200-4M3 289 €	A1200-4M4 359 €	
400	1670	1350	1300	1	A1300-4M3 300 €	A1300-4M4 373 €	
400	1670	1450	1400	1	A1400-4M3 309 €	A1400-4M4 387 €	
400	1670	1550	1500	1	A1500-4M3 321 €	A1500-4M4 402 €	
400	1670	1650	1600	1	A1600-4M3 333 €	A1600-4M4 418 €	
400	1970	650	600	1	A600-4G3 231 €	A600-4G4 278 €	A600-4G5 324 €
400	1970	750	700	1	A700-4G3 243 €	A700-4G4 294 €	A700-4G5 344 €
400	1970	850	800	1	A800-4G3 255 €	A800-4G4 309 €	A800-4G5 364 €
400	1970	950	900	1	A900-4G3 264 €	A900-4G4 321 €	A900-4G5 379 €
400	1970	1050	1000	1	A1000-4G3 276 €	A1000-4G4 337 €	A1000-4G5 398 €
400	1970	1150	1100	1	A1100-4G3 291 €	A1100-4G4 357 €	A1100-4G5 423 €
400	1970	1250	1200	1	A1200-4G3 302 €	A1200-4G4 373 €	A1200-4G5 443 €
400	1970	1350	1300	1	A1300-4G3 314 €	A1300-4G4 389 €	A1300-4G5 463 €
400	1970	1450	1400	1	A1400-4G3 323 €	A1400-4G4 400 €	A1400-4G5 478 €
400	1970	1550	1500	1	A1500-4G3 335 €	A1500-4G4 416 €	A1500-4G5 497 €
400	1970	1650	1600	1	A1600-4G3 347 €	A1600-4G4 432 €	A1600-4G5 517 €
500	1370	650	600	1	A600-5P3 219 €	A600-5P4 272 €	
500	1370	750	700	1	A700-5P3 234 €	A700-5P4 292 €	
500	1370	850	800	1	A800-5P3 246 €	A800-5P4 307 €	
500	1370	950	900	1	A900-5P3 264 €	A900-5P4 331 €	
500	1370	1050	1000	1	A1000-5P3 276 €	A1000-5P4 347 €	
500	1370	1150	1100	1	A1100-5P3 288 €	A1100-5P4 363 €	
500	1370	1250	1200	1	A1200-5P3 302 €	A1200-5P4 383 €	
500	1370	1350	1300	1	A1300-5P3 317 €	A1300-5P4 402 €	
500	1370	1450	1400	1	A1400-5P3 329 €	A1400-5P4 418 €	
500	1370	1550	1500	1	A1500-5P3 341 €	A1500-5P4 434 €	
500	1370	1650	1600	1	A1600-5P3 353 €	A1600-5P4 450 €	
500	1670	650	600	1	A600-5M3 236 €	A600-5M4 289 €	
500	1670	750	700	1	A700-5M3 251 €	A700-5M4 308 €	
500	1670	850	800	1	A800-5M3 263 €	A800-5M4 324 €	
500	1670	950	900	1	A900-5M3 281 €	A900-5M4 348 €	
500	1670	1050	1000	1	A1000-5M3 293 €	A1000-5M4 364 €	
500	1670	1150	1100	1	A1100-5M3 304 €	A1100-5M4 380 €	
500	1670	1250	1200	1	A1200-5M3 319 €	A1200-5M4 399 €	
500	1670	1350	1300	1	A1300-5M3 334 €	A1300-5M4 419 €	
500	1670	1450	1400	1	A1400-5M3 346 €	A1400-5M4 435 €	
500	1670	1550	1500	1	A1500-5M3 358 €	A1500-5M4 451 €	
500	1670	1650	1600	1	A1600-5M3 370 €	A1600-5M4 467 €	
500	1970	650	600	1	A600-5G3 253 €	A600-5G4 305 €	A600-5G5 358 €
500	1970	750	700	1	A700-5G3 268 €	A700-5G4 325 €	A700-5G5 383 €
500	1970	850	800	1	A800-5G3 280 €	A800-5G4 341 €	A800-5G5 402 €
500	1970	950	900	1	A900-5G3 297 €	A900-5G4 365 €	A900-5G5 432 €
500	1970	1050	1000	1	A1000-5G3 309 €	A1000-5G4 381 €	A1000-5G5 452 €
500	1970	1150	1100	1	A1100-5G3 321 €	A1100-5G4 396 €	A1100-5G5 472 €
500	1970	1250	1200	1	A1200-5G3 336 €	A1200-5G4 416 €	A1200-5G5 496 €
500	1970	1350	1300	1	A1300-5G3 351 €	A1300-5G4 436 €	A1300-5G5 521 €
500	1970	1450	1400	1	A1400-5G3 363 €	A1400-5G4 452 €	A1400-5G5 541 €
500	1970	1550	1500	1	A1500-5G3 375 €	A1500-5G4 468 €	A1500-5G5 561 €
500	1970	1650	1600	1	A1600-5G3 387 €	A1600-5G4 484 €	A1600-5G5 581 €

fondo mm depth mm	alto mm height mm	largo mm length mm	disposición de estantes shelf layout	escaleras uprights	3 niveles - 3 levels ref. ref.	€	4 niveles - 4 levels ref. ref.	€	5 niveles - 5 levels ref. ref.	€
400	1370	635	600	1	C600-4P3	171 €	C600-4P4	205 €		
400	1370	735	700	1	C700-4P3	177 €	C700-4P4	214 €		
400	1370	835	800	1	C800-4P3	189 €	C800-4P4	230 €		
400	1370	935	900	1	C900-4P3	198 €	C900-4P4	242 €		
400	1370	1035	1000	1	C1000-4P3	209 €	C1000-4P4	258 €		
400	1370	1135	1100	1	C1100-4P3	224 €	C1100-4P4	278 €		
400	1370	1235	1200	1	C1200-4P3	236 €	C1200-4P4	294 €		
400	1370	1335	1300	1	C1300-4P3	251 €	C1300-4P4	314 €		
400	1370	1435	1400	1	C1400-4P3	257 €	C1400-4P4	321 €		
400	1370	1535	1500	1	C1500-4P3	269 €	C1500-4P4	336 €		
400	1370	1635	1600	1	C1600-4P3	281 €	C1600-4P4	351 €		
400	1670	635	600	1	C600-4M3	179 €	C600-4M4	212 €		
400	1670	735	700	1	C700-4M3	191 €	C700-4M4	228 €		
400	1670	835	800	1	C800-4M3	202 €	C800-4M4	244 €		
400	1670	935	900	1	C900-4M3	211 €	C900-4M4	256 €		
400	1670	1035	1000	1	C1000-4M3	223 €	C1000-4M4	272 €		
400	1670	1135	1100	1	C1100-4M3	238 €	C1100-4M4	292 €		
400	1670	1235	1200	1	C1200-4M3	250 €	C1200-4M4	307 €		
400	1670	1335	1300	1	C1300-4M3	262 €	C1300-4M4	323 €		
400	1670	1435	1400	1	C1400-4M3	271 €	C1400-4M4	335 €		
400	1670	1535	1500	1	C1500-4M3	283 €	C1500-4M4	351 €		
400	1670	1635	1600	1	C1600-4M3	295 €	C1600-4M4	367 €		
400	1970	635	600	1	C600-4G3	187 €	C600-4G4	219 €	C600-4G5	251 €
400	1970	735	700	1	C700-4G3	204 €	C700-4G4	242 €	C700-4G5	280 €
400	1970	835	800	1	C800-4G3	216 €	C800-4G4	258 €	C800-4G5	299 €
400	1970	935	900	1	C900-4G3	225 €	C900-4G4	270 €	C900-4G5	314 €
400	1970	1035	1000	1	C1000-4G3	237 €	C1000-4G4	286 €	C1000-4G5	334 €
400	1970	1135	1100	1	C1100-4G3	252 €	C1100-4G4	305 €	C1100-4G5	359 €
400	1970	1235	1200	1	C1200-4G3	264 €	C1200-4G4	321 €	C1200-4G5	379 €
400	1970	1335	1300	1	C1300-4G3	273 €	C1300-4G4	332 €	C1300-4G5	394 €
400	1970	1435	1400	1	C1400-4G3	285 €	C1400-4G4	349 €	C1400-4G5	413 €
400	1970	1535	1500	1	C1500-4G3	297 €	C1500-4G4	366 €	C1500-4G5	433 €
400	1970	1635	1600	1	C1600-4G3	308 €	C1600-4G4	383 €	C1600-4G5	453 €
500	1370	635	600	1	C600-5P3	178 €	C600-5P4	216 €		
500	1370	735	700	1	C700-5P3	190 €	C700-5P4	232 €		
500	1370	835	800	1	C800-5P3	201 €	C800-5P4	248 €		
500	1370	935	900	1	C900-5P3	225 €	C900-5P4	272 €		
500	1370	1035	1000	1	C1000-5P3	231 €	C1000-5P4	288 €		
500	1370	1135	1100	1	C1100-5P3	243 €	C1100-5P4	303 €		
500	1370	1235	1200	1	C1200-5P3	258 €	C1200-5P4	323 €		
500	1370	1335	1300	1	C1300-5P3	273 €	C1300-5P4	343 €		
500	1370	1435	1400	1	C1400-5P3	285 €	C1400-5P4	359 €		
500	1370	1535	1500	1	C1500-5P3	297 €	C1500-5P4	375 €		
500	1370	1635	1600	1	C1600-5P3	308 €	C1600-5P4	391 €		
500	1670	635	600	1	C600-5M3	195 €	C600-5M4	233 €		
500	1670	735	700	1	C700-5M3	206 €	C700-5M4	249 €		
500	1670	835	800	1	C800-5M3	218 €	C800-5M4	265 €		
500	1670	935	900	1	C900-5M3	236 €	C900-5M4	289 €		
500	1670	1035	1000	1	C1000-5M3	248 €	C1000-5M4	304 €		
500	1670	1135	1100	1	C1100-5M3	260 €	C1100-5M4	320 €		
500	1670	1235	1200	1	C1200-5M3	275 €	C1200-5M4	340 €		
500	1670	1335	1300	1	C1300-5M3	290 €	C1300-5M4	360 €		
500	1670	1435	1400	1	C1400-5M3	301 €	C1400-5M4	376 €		
500	1670	1535	1500	1	C1500-5M3	313 €	C1500-5M4	392 €		
500	1670	1635	1600	1	C1600-5M3	325 €	C1600-5M4	407 €		
500	1970	635	600	1	C600-5G3	211 €	C600-5G4	250 €	C600-5G5	289 €
500	1970	735	700	1	C700-5G3	223 €	C700-5G4	266 €	C700-5G5	308 €
500	1970	835	800	1	C800-5G3	235 €	C800-5G4	282 €	C800-5G5	328 €
500	1970	935	900	1	C900-5G3	247 €	C900-5G4	305 €	C900-5G5	358 €
500	1970	1035	1000	1	C1000-5G3	265 €	C1000-5G4	321 €	C1000-5G5	378 €
500	1970	1135	1100	1	C1100-5G3	277 €	C1100-5G4	337 €	C1100-5G5	397 €
500	1970	1235	1200	1	C1200-5G3	292 €	C1200-5G4	357 €	C1200-5G5	422 €
500	1970	1335	1300	1	C1300-5G3	306 €	C1300-5G4	377 €	C1300-5G5	447 €
500	1970	1435	1400	1	C1400-5G3	318 €	C1400-5G4	393 €	C1400-5G5	467 €
500	1970	1535	1500	1	C1500-5G3	330 €	C1500-5G4	408 €	C1500-5G5	487 €
500	1970	1635	1600	1	C1600-5G3	342 €	C1600-5G4	424 €	C1600-5G5	506 €



## EQUIPOS FRIGORIFICOS COOLING UNITS



## intarblock de puerta



Equipos compactos monoblock R-290 para minicámaras frigoríficas de refrigeración y congelación, para montaje sobre el panel de puerta de la cámara.

### ESPECIFICACIONES TÉCNICAS

Carga de refrigerante R-290.	■
Compresor hermético alternativo.	■
Presostato de alta presión y baja presión.	■
Expansión por válvula termostática.	■
Protección magnetotérmica.	■
Desescarche por inyección de gas caliente.	■
Bandeja de condensados en acero inoxidable.	■
Evaporación automática de condensados.	■
Luz led de cámara con micro-interruptor de puerta.	■
Regulación electrónica multifunción.	■
Tratamiento anticorrosión en epoxi de la batería de evaporación.	□ + 6 %

■ De serie □ Opcional

### ESQUEMA DE INSTALACIÓN

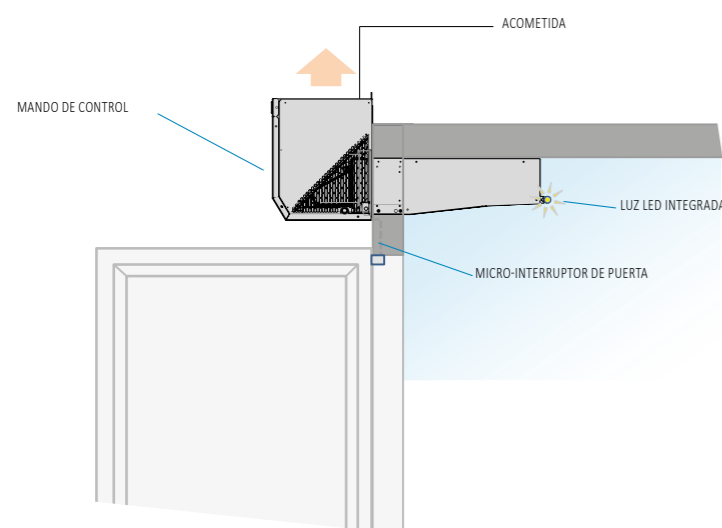

### Ejemplo de instalación



### Luz led de cámara integrada

Luz led de cámara de gran eficiencia, integrada en el equipo, que se activa automáticamente al abrirse la puerta de la cámara.

### Controlador electrónico

La regulación electrónica XW60LH, de serie en nuestros equipos compactos comerciales de puerta, es un avanzado controlador de reducido tamaño, que incluye las siguientes funciones:



- Control de temperatura con registro de temperaturas máxima y mínima.
- Función Jet Cool de enfriamiento rápido.
- Modo de funcionamiento nocturno.
- Función Energy Saving.
- 4 relés de salida para: compresor, ventilador, desescarche y luz.
- 3 sondas NTC de temperatura para cámara, desescarche y condensación.

### 230V I+N ~ 50Hz | Media temperatura | Compresor hermético | R-290

Refrigerante	Serie / Modelo	Alimentación	Compresor (CV)	Potencia frigorífica / Volumen de cámara, según temperatura de cámara <sup>(1)</sup>						Potencia absorbida nominal (W)	Intens. máxima absorbida (A)	Caudal evap. (m³/h)	Carga de refrigerante (g) <sup>(2)</sup>	Peso (kg)	SPL dB(A) <sup>(3)</sup>	PVP (€)
				0 °C		5 °C		10 °C								
				W	m³	W	m³	W	m³							
R-290	MCP-ND-0009A	230V I+N ~ 50Hz	1/3	640	6	810	8	945	13	340	3,1	275	<100	61	29	2 469
	MCP-ND-1012A	230V I+N ~ 50Hz	1/2	969	9	1 235	15	1 430	27	520	4,3	550	<100	67	29	2 990
	MCP-ND-1017A	230V I+N ~ 50Hz	3/4	1 209	14	1 530	20	1 765	35	720	4,5	550	<100	67	31	3 380

### 230V I+N ~ 50Hz | Baja temperatura | Compresor hermético | R-290

Refrigerante	Serie / Modelo	Alimentación	Compresor (CV)	Potencia frigorífica / Volumen de cámara, según temperatura de cámara <sup>(1)</sup>						Potencia absorbida nominal (W)	Intens. máxima absorbida (A)	Caudal evap. (m³/h)	Carga de refrigerante (g) <sup>(2)</sup>	Peso (kg)	SPL dB(A) <sup>(3)</sup>	PVP (€)
				-25 °C		-20 °C		-15 °C								
				W	m³	W	m³	W	m³							
R-290	BCP-ND-0014A	230V I+N ~ 50Hz	3/4	420	1	464	2,5	590	5	300	3,3	275	<100	62	29	2 873
	BCP-ND-1017A	230V I+N ~ 50Hz	3/4	575	2	639	6	825	9	340	4,3	550	<170	67	29	3 250
	BCP-ND-1028A	230V I+N ~ 50Hz	1 1/4	750	4	833	9	1 070	15	640	6,0	550	<150	74	31	3 668

<sup>(1)</sup> Las prestaciones nominales están referidas al funcionamiento con temperatura de cámara de 0 °C (MT) y -20 °C (BT), y temperatura exterior de 35 °C. <sup>(2)</sup> Carga de refrigerante A3 inferior a 500 g, simplificación del cumplimiento RSIF. <sup>(3)</sup> Nivel de presión sonora del condensador en campo libre, con directividad 1, medido a 10 m de la fuente (valor no vinculante calculado a partir de la potencia sonora).

### DIMENSIONES

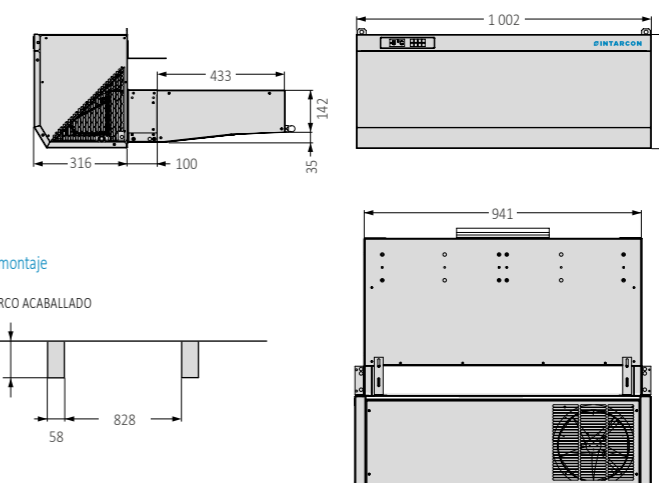

### Marco de montaje

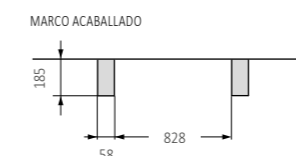

Cotas en mm.

CLIENT360  
client360.intarcon.com  
SOFTWARE DE CÁLCULO FRIGORÍFICO



## intarblock



Equipos ultra compactos monoblocks diseñados para minicámaras frigoríficas de refrigeración y congelación, montaje en ventana sobre la pared de la cámara.

### ESPECIFICACIONES TÉCNICAS

Carga de refrigerante R-290.	■
Compresor hermético alternativo.	■
Motoventiladores electrónicos EC.	■
Presostatos de alta y baja presión.	■
Expansión por válvula termostática.	■
Desescarche por inyección de gas caliente.	■
Bandeja de condensados en acero inoxidable.	■
Evaporación automática de condensados.	■
Luz led de cámara con micro-interruptor de puerta.	■
Tampón desmontable incluido.	■
Regulación electrónica multifunción.	■
Tratamiento anticorrosión en epoxi de la batería de evaporación.	□ + 6 %

■ De serie □ Opcional

### ESQUEMA DE INSTALACIÓN

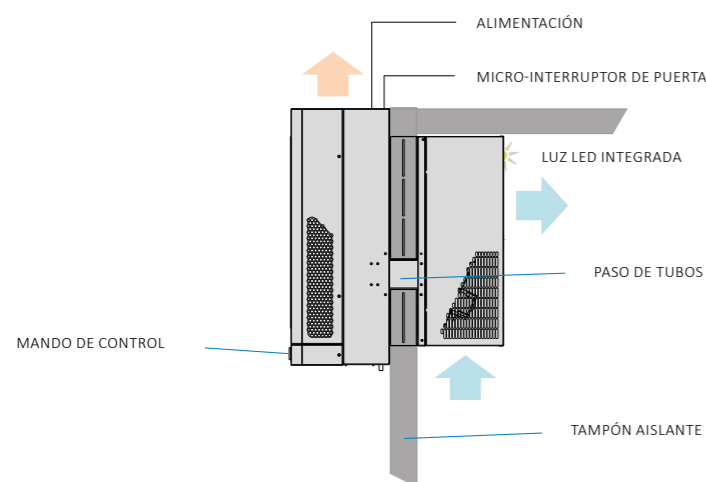

### Ejemplo de instalación



### Controlador electrónico

La regulación electrónica XW60LH, de serie en nuestros equipos compactos comerciales slim de pared, es un avanzado controlador de reducido tamaño, que incluye las siguientes funciones:



- Control de temperatura con registro de temperaturas máxima y mínima.
- Función Jet Cool de enfriamiento rápido.
- Modo de funcionamiento nocturno.
- 4 relés de salida para: compresor, ventilador, desescarche y luz.
- 3 sondas NTC de temperatura para termostato, desescarche y condensación.

### Luz led de cámara integrada

Luz led de cámara de gran eficiencia, integrada en el equipo, que se activa automáticamente al abrirse la puerta de la cámara.

### 230V I+N ~ 50Hz | Media temperatura | Compresor hermético | R-290

Refrigerante	Serie / Modelo	Alimentación	Compresor (CV)	Potencia frigorífica / Volumen de cámara, según temperatura de cámara <sup>(1)</sup>						Potencia absorbida nominal (W)	Intens. máxima absorbida (A)	Caudal evap. (m³/h)	Carga de refrigerante (g) <sup>(2)</sup>	Peso (kg)	SPL dB(A) <sup>(3)</sup>	PVP (€)
				0 °C		5 °C		10 °C								
				W	m³	W	m³	W	m³							
R-290	MCV-LD-0009A	230V I+N ~ 50Hz	1/3	635	5	740	7	850	12	400	3,5	300	< 100	38	29	2 259
	MCV-LD-1012A	230V I+N ~ 50Hz	1/2	1 050	9	1 220	15	1 410	27	520	3,3	500	< 150	56	29	2 719
	MCV-LD-1017A	230V I+N ~ 50Hz	3/4	1 340	14	1 560	21	1 780	36	680	4,3	500	< 150	57	31	3 031
	MCV-LD-2026A	230V I+N ~ 50Hz	1	1 824	21	2 170	34	2 540	58	940	5,9	950	< 150	86	35	3 847
	MCV-LD-2034A	230V I+N ~ 50Hz	1	2 215	27	2 618	43	2 960	70	1 310	9,0	950	< 200	86	35	4 821

### 230V I+N ~ 50Hz | Baja temperatura | Compresor hermético | R-290

Refrigerante	Serie / Modelo	Alimentación	Compresor (CV)	Potencia frigorífica / Volumen de cámara, según temperatura de cámara <sup>(1)</sup>						Potencia absorbida nominal (W)	Intens. máxima absorbida (A)	Caudal evap. (m³/h)	Carga de refrigerante (g) <sup>(2)</sup>	Peso (kg)	SPL dB(A) <sup>(3)</sup>	PVP (€)
				-25 °C		-20 °C		-15 °C								
				W	m³	W	m³	W	m³							
R-290	BCV-LD-0014A	230V I+N ~ 50Hz	3/4	370	1	440	2	520	4	380	3,6	300	< 100	38	29	2 682
	BCV-LD-1017A	230V I+N ~ 50Hz	3/4	540	2	660	5	790	8	480	4,3	500	< 100	57	29	2 979
	BCV-LD-1028A	230V I+N ~ 50Hz	1 1/4	770	4	920	9	1 090	15	730	5,6	500	< 150	64	31	3 280
	BCV-LD-2034A	230V I+N ~ 50Hz	3/4	985	7	1 210	14	1 470	25	970	9,3	950	< 200	86	34	3 520

<sup>(1)</sup> Las prestaciones nominales están referidas al funcionamiento con temperatura de cámara de 0 °C (MT) y -20 °C (BT), y temperatura exterior de 35 °C. Volumen de cámara estimado según condiciones de las bases de cálculo (pág. 12).

<sup>(2)</sup> Carga de refrigerante A3 inferior a 500 g, simplificación del cumplimiento RSIF.

<sup>(3)</sup> Nivel de presión sonora del condensador en campo libre, con directividad 1, medido a 10 m de la fuente (valor no vinculante calculado a partir de la potencia sonora).

### DIMENSIONES

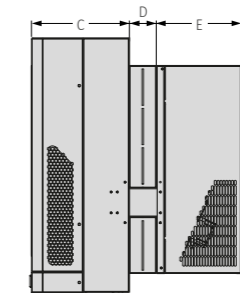
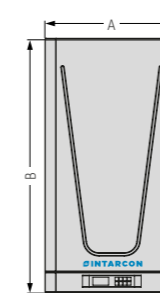

### Marco de montaje

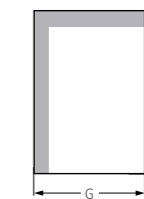

CALADO TAMPÓN

Dimensiones (mm)	A	B	C	D	E	F	G	H
Serie 0	420	803	237	86	207	596	400	600
Serie 1	420	803	307	86	270	656	400	660
Serie 2	620	764	343	106	310	676	600	680

CLIENT360  
client360.intarcon.com  
SOFTWARE DE CÁLCULO FRIGORÍFICO



## intarblock A2L



Nuevos equipos monoblock de A2L para cámaras frigoríficas de pequeño tamaño de refrigeración y congelación, para montaje en pared.

### ESPECIFICACIONES TÉCNICAS

Carga de R-455A.	■
Compresor hermético alternativo.	■
Presostato de alta presión.	■
Expansión por válvula termostática.	■
Protección magnetotérmica.	■
Desescarche por inyección de gas caliente.	■
Bandeja de condensados.	■
Evaporación automática de condensados.	■
Luz de cámara led y cable interruptor de puerta.	■
Cajón de evaporación en panel sándwich de 50 mm de espuma de poliuretano, revestido interiormente con chapa de acero prelacado.	■
Regulación electrónica multifunción.	■
Cambio a alimentación 400V 3N 50Hz.	□ + 5 %
Ventilador centrífugo de impulsión vertical.	□ + 15 %
Tratamiento anticorrosión en epoxi de la batería de evaporación.	□ + 6 %
Tratamiento anticorrosión de poliuretano de la batería de condensación.	□ + 4 %
Control de tensión (modelos monofásicos).	□ + 195 €
Control de tensión y fallo de fase (modelos trifásicos).	□ + 259 €

■ De serie □ Opcional

### ESQUEMA DE INSTALACIÓN

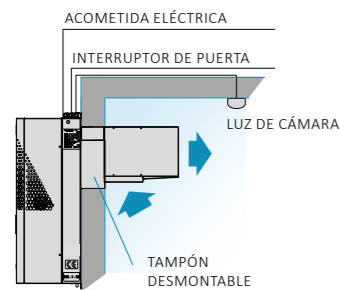

Montaje tampón  
Se suministra de serie un tampón desmontable para montaje directo sobre ventana en la cámara frigorífica.

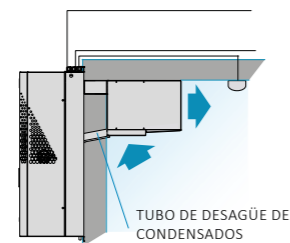

Montaje acaballado (excepto serie 0)  
Es posible realizar un montaje acaballado de forma sencilla, simplemente preparando un marco para su instalación y posteriormente colocando el techo de la cámara.

### Ejemplo de instalación



### Controlador electrónico

Los equipos intarblock incorporan de serie el avanzado controlador electrónico XW270K.



- Mando multifunción de control digital a distancia.
- Control de temperatura con registro de temperaturas máxima y mínima.
- Función Jet Cool de enfriamiento rápido.
- Modo de funcionamiento nocturno.

### Accesorios equipos CV-NN

- Tolda de adaptación a conducto circular (+ 131 €).
- Compuerta antirretorno (+ 72 €).
- Micro-interruptor de puerta (+ 67 €).

### 230V I+N ~ 50Hz / 400V 3N ~ 50Hz | Media temperatura | Compresor hermético | R-455A

Refrigerante	Serie / Modelo Axial	Alimentación	Compresor (CV)	Potencia frigorífica / Volumen de cámara, según temperatura de cámara <sup>(1)</sup>						Potencia abs. nominal (W)	Intens. máx. abs. (A)	Caudal evap. (m³/h)	Caudal cond. (m³/h)	PSD (Pa) <sup>(2)</sup>	Carga de refrig. (kg)	Peso (kg)	SPL dB(A) <sup>(3)</sup>	PVP (€)
				0 °C		5 °C		10 °C										
				W	m³	W	m³	W	m³									
R-455A	MCV-NN-0010A	230V I+N ~ 50Hz	1/3	691	5	818	9	938	15	480	7,1	400	375	80	<1,0	37	34	2 053
	MCV-NN-1016A	230V I+N ~ 50Hz	3/4	1 083	10	1 271	17	1 470	27	740	9,4	425	575	80	<1,0	70	34	2 577
	MCV-NN-2024A	230V I+N ~ 50Hz	1	1 766	19	2 094	32	2 428	51	1 122	14,7	800	950	130	<1,5	89	35	3 516
	MCV-NN-2026A	230V I+N ~ 50Hz	1 1/2	1 869	21	2 215	34	2 561	55	1 225	15,4	800	950	130	<1,5	89	36	3 721
	MCV-NN-3034A	230V I+N ~ 50Hz*	1 1/2	2 357	28	2 810	46	3 291	75	1 550	20,4	1 100	1 150	80	<2,0	101	38	4 297
	MCV-NN-3038A	400V 3N ~ 50Hz	1 3/4	2 522	30	3 007	50	3 505	81	1 654	9,5	1 100	1 150	80	<2,0	101	40	4 668

### 230V I+N ~ 50Hz | Baja temperatura | Compresor hermético | R-455A

Refrigerante	Serie / Modelo	Alimentación	Compresor (CV)	Potencia frigorífica / Volumen de cámara, según temperatura de cámara <sup>(1)</sup>						Potencia abs. nominal (W)	Intens. máx. abs. (A)	Caudal evap. (m³/h)	Caudal cond. (m³/h)	PSD (Pa) <sup>(2)</sup>	Carga de refrig. (kg)	Peso (kg)	SPL dB(A) <sup>(3)</sup>	PVP (€)
				-25 °C		-20 °C		-15 °C										
				W	m³	W	m³	W	m³									
R-455A	BCV-NN-0018A	230V I+N ~ 50Hz	3/4	375	1	468	2	573	3	502	8,4	400	375	80	<0,5	47	31	2 705
	BCV-NN-1034A	230V I+N ~ 50Hz	1 1/2	677	3	836	6	989	10	993	12,6	425	575	80	<1,0	71	33	3 204
	BCV-NN-2034A	230V I+N ~ 50Hz	1 1/2	848	5	1 065	9	1 303	15	1 110	13,4	800	950	130	<1,0	90	35	3 420
	BCV-NN-2055A	230V I+N ~ 50Hz	2	1 090	8	1 377	14	1 678	23	1 398	19,5	800	950	130	<1,5	96	41	4 093
	BCV-NN-3068A	230V I+N ~ 50Hz*	3	1 562	14	1 936	24	2 358	38	2 013	23,5	1 100	1 150	80	<1,5	113	44	4 988

<sup>(1)</sup> Las prestaciones nominales están referidas al funcionamiento con temperatura de cámara de 0 °C (MT) y -20 °C (BT), y temperatura exterior de 35 °C. <sup>(2)</sup> Presión estática disponible de condensación.

<sup>(3)</sup> Nivel de presión sonora del condensador en campo libre, con directividad 1, medido a 10 m de la fuente (valor no vinculante calculado a partir de la potencia sonora).

\* Unidades disponibles en tensión 400V 3N 50Hz.

### DIMENSIONES

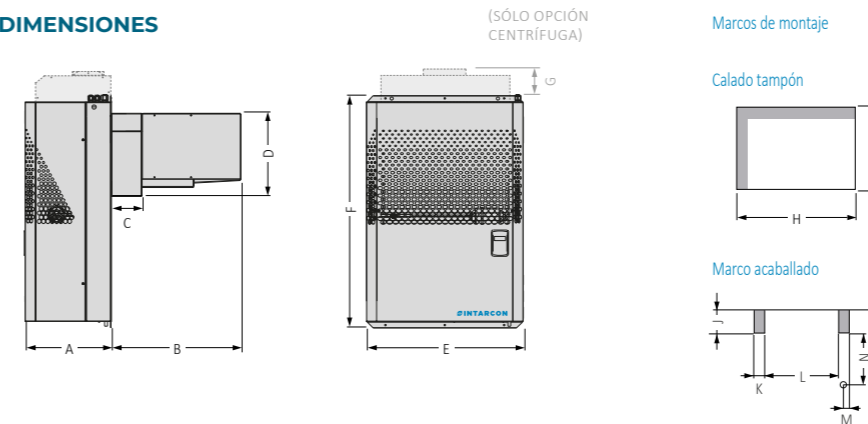

Dimensiones (mm)	A	B	C	D	E	F	G	H	I	J	K	L	M	N	Embocadura turbina
Serie 0	306	250	100	510	420	683	90	405	515	n/a	n/a	n/a	n/a	n/a	185 x 115
Serie 1	340	514	122	330	400	880	42	380	335	75	38	295	21	218	185 x 115
Serie 2	340	514	122	330	620	920	140	600	335	75	30	522	16	218	230 x 130
Serie 3	365	514	122	470	735	940	50	715	475	75	45	607	20	356	2x 185 x 115

### Versión centrífuga

Los equipos de la serie intarblock centrífuga incorporan una turbina centrífuga para permitir la conducción hacia el exterior del aire caliente de descarga mediante conductos.

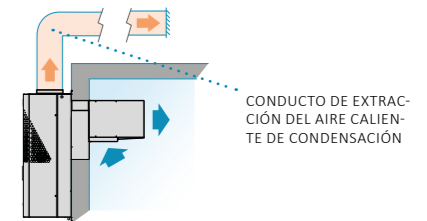

### Conductos de extracción de aire

Dimensiones recomendadas para conductos de descarga en chapa, PVC, o panel de lana de vidrio, de 20 m de longitud (cada codo a 90° equivale a 5 m de longitud). Para conductos flexibles o semirígidos se recomienda utilizar una dimensión mayor.

- Serie 0: 200 x 150 mm o Ø 150 mm
- Serie 1: 200 x 200 mm o Ø 150 mm
- Serie 2: 250 x 150 mm o Ø 200 mm
- Serie 3: 300 x 200 mm o Ø 250 mm

CLIENT360  
client360.intarcon.com  
SOFTWARE DE CÁLCULO FRIGORÍFICO



## intarblock PRO



Nuevos equipos compactos monoblock R-290 de pared diseñados por y para instaladores. Para pequeñas y medianas cámaras frigoríficas de refrigeración y conservación. Montaje acaballado sobre la pared de la cámara.

### ESPECIFICACIONES TÉCNICAS

Carga de refrigerante R-290.	■
Circuito frigorífico independiente por compresor.	■
Compresores herméticos montados sobre railes para disminuir vibraciones.	■
Batería condensadora en microcanal con tratamiento de pintura poliéster.	■
Ventiladores del evaporador AC, y EC en condensador.	■
Presostato de alta presión.	■
Bandeja de condensados en inoxidable, extraíble para limpieza, y serpentín de cobre con pintura epoxi.	■
Manta filtrante en rejilla de aspiración lavable.	■
Resistencia de desagüe en modelos de BT.	■
Montaje acaballado 80-150 mm.	■
Acceso a cuadro eléctrico con registro abatible.	■
Desescarche por gas caliente.	■
Expansión por válvula termostática.	■
Chapas de aluminio recubiertas de film para protección en transporte en evaporador.	■
Mando multifunción integrado en el equipo.	■
Luz led de cámara.	■
Ventilador radial con impulsión vertical EC (solo en equipos estándar condensados por aire).	□ + 10 %
Adaptación a bitémpero.	□ + 10 %
Adaptación a equipo para instalación en intemperie.	□ + 30 %
Base macho y clavija hembra de conexión industrial.	□ + 80 €
Control de tensión (modelos monofásicos).	□ + 195 €
Control de tensión y fallo de fase (modelos trifásicos).	□ + 259 €
Cambio alimentación a 230V 50Hz (modelos trifásicos).	□ + 8 %
Resistencia de desagüe (para temperatura de cámara < 0 °C en modelos de MT).	□ + 91 €
Maestro-esclavo (alternativo + simultáneo).	□ + 85 €

■ De serie □ Opcional

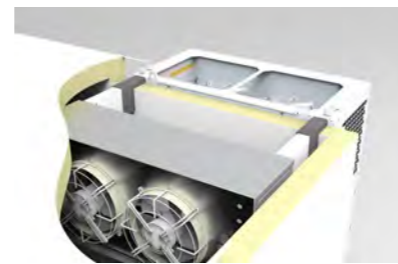

### Evaporador tipo cúbico de aluminio

El aluminio proporciona una mejor transferencia de calor frente a otros materiales, además de un óptimo funcionamiento en baja temperatura. Los evaporadores tipo cúbico tiene un mayor alcance de aire que los evaporadores tipo plafón.

### Controlador electrónico

Los equipos intarblock PRO incorporan de serie el avanzado controlador electrónico XM670K.



- Mando multifunción de control digital.
- Reloj interno para programación de ciclos de ahorro de energía y desescarches.
- Posibilidad de interconexión y sincronización de hasta 8 equipos en red LAN, gestionados con un solo mando de control.

### Accesorios equipos CV-NPD

- Tampón de cámara de 100 mm (+ 4 %).
- Tampón de cámara de 150 mm (+ 6 %).
- Compuerta antirretorno (+ 72€).
- Micro-interruptor de puerta (+ 67 €).
- Manguera eléctrica de acometida de 5 m (+ 2 %).

### ESQUEMA DE INSTALACIÓN

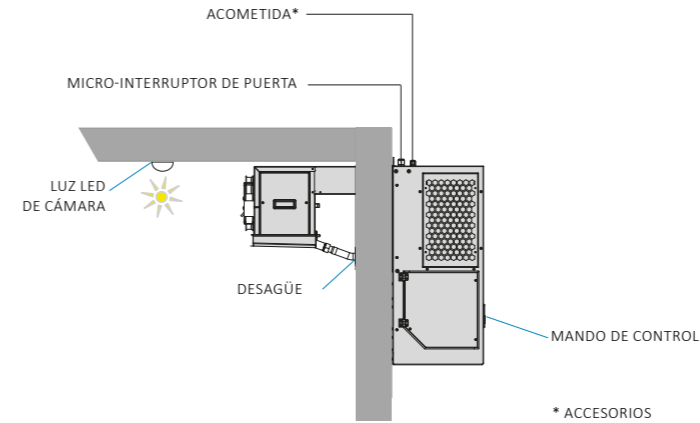

\* ACCESORIOS



### 230V I+N ~ 50Hz / 400V 3N ~ 50Hz | Media temperatura | Compresor hermético | R-290

Refrigerante	Serie / Modelo	Alimentación	Compresor (CV)	Potencia frigorífica / Volumen de cámara, según temperatura de cámara <sup>(1)</sup>						Potencia absorbida nominal (W)	Intens. máxima absorbida (A)	Caudal evap. (m³/h)	Caudal conden. [Opc. radial] (m³/h)	Carga de refrigerante por circuito (g) <sup>(2)</sup>	Peso (kg)	SPL dB(A) <sup>(3)</sup>	PVP (€)
				0 °C		5 °C		10 °C									
				W	m³	W	m³	W	m³								
R-290	MCV-NPD-1008A	230V I+N ~ 50Hz	1/3	720	5	851	10	995	16	464	4,1	750	1 450	< 150	68	43	2 753
	MCV-NPD-1012A	230V I+N ~ 50Hz	1/2	958	8	1 144	14	1 345	24	635	6,5	750	1 450	< 150	68	43	3 131
	MCV-NPD-1018A	230V I+N ~ 50Hz	3/4	1 220	12	1 447	20	1 688	33	759	5,8	750	1 450	< 150	72	43	3 688
	MCV-NPD-2026A	230V I+N ~ 50Hz	1	1 733	19	2 086	32	2 491	53	1 107	11,2	1 350	1 600	< 500	109	41	4 544
	MCV-NPD-2034A	230V I+N ~ 50Hz	1	2 251	26	2 668	43	3 119	70	1 491	14,8	1 350	1 600	< 500	109	42	5 088
	MCV-NPD-2035A	230V I+N ~ 50Hz	2x 3/4	2 432	29	2 847	47	3 302	75	1 459	11,1	1 350	1 600	< 150	116	41	5 877
	MCV-NPD-3052A	400V 3N ~ 50Hz*	2x 1	3 578	47	4 329	78	5 065	140	2 309	9,3	2 800	3 000	< 150	142	44	6 382
MCV-NPD-3069A	400V 3N ~ 50Hz*	2x 1	4 505	62	5 329	100	6 180	180	3 091	12,9	2 800	3 000	< 500	142	45	7 077	

### 230V I+N ~ 50Hz / 400V 3N ~ 50Hz | Baja temperatura | Compresor hermético | R-290

Refrigerante	Serie / Modelo	Alimentación	Compresor (CV)	Potencia frigorífica / Volumen de cámara, según temperatura de cámara <sup>(1)</sup>						Potencia absorbida nominal (W)	Intens. máxima absorbida (A)	Caudal evap. (m³/h)	Caudal conden. [Opc. radial] (m³/h)	Carga de refrigerante por circuito (g) <sup>(2)</sup>	Peso (kg)	SPL dB(A) <sup>(3)</sup>	PVP (€)
				-25 °C		-20 °C		-15 °C									
				W	m³	W	m³	W	m³								
R-290	BCV-NPD-1018A	230V I+N ~ 50Hz	3/4	469	1	584	3	706	5	588	5,8	750	1 450	< 150	72	43	3 801
	BCV-NPD-2026A	230V I+N ~ 50Hz	3/4	703	3	867	6	1 085	11	907	9,6	1 350	1 600	< 150	109	41	3 919
	BCV-NPD-2034A	230V I+N ~ 50Hz	3/4	955	6	1 166	10	1 423	18	1 141	11,5	1 350	1 600	< 150	109	41	4 457
	BCV-NPD-3052A	230V I+N ~ 50Hz	2x 3/4	1 406	12	1 776	21	2 249	36	1 926	18,1	2 800	3 000	< 150	142	44	5 761
	BCV-NPD-3054A	230V I+N ~ 50Hz	1	1 367	11	1 787	21	2 323	38	1 732	18,2	2 800	3 000	< 500	131	45	5 487
	BCV-NPD-3068A	400V 3N ~ 50Hz*	1 1/4	1 665	15	2 173	28	2 792	49	2 028	11,9	2 800	3 000	< 500	131	44	6 101
	BCV-NPD-3069A	400V 3N ~ 50Hz*	2x 3/4	1 905	19	2 372	32	2 898	52	2 402	11,9	2 800	3 000	< 150	142	46	6 291

<sup>(1)</sup> Las prestaciones nominales están referidas al funcionamiento con temperatura de cámara de 0 °C (MT) y -20 °C (BT), y temperatura exterior de 35 °C. Volumen de cámara estimado según condiciones de las bases de cálculo (pág. 12).

<sup>(2)</sup> Carga de refrigerante A3 inferior a 500 g, simplificación del cumplimiento RSIF.

<sup>(3)</sup> Nivel de presión sonora del condensador en campo libre, con directividad 1, medido a 10 m de la fuente (valor no vinculante calculado a partir de la potencia sonora).

\* Modelo disponible a 230V 50Hz.

### DIMENSIONES

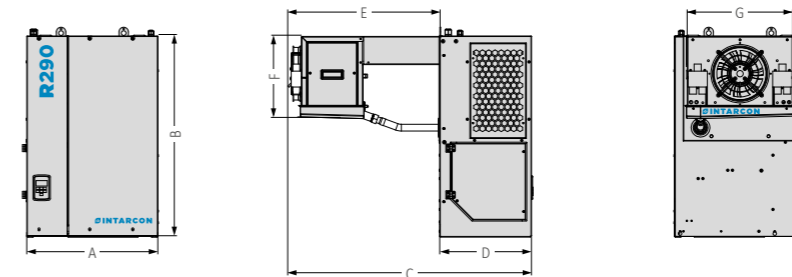

Dimensiones (mm)	A	B	C	D	E	F	G	H	I	J	K	L
Serie 1	556	853	1 023	390	693	348	468	448	56	341	129	450
Serie 2	706	853	1 173	455	720	448	618	640	56	491	129	560
Serie 3	906	853	1 101	455	686	455	878	890	56	761	129	560

### Marco de montaje acaballado

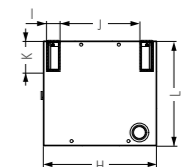

CLIENT360  
client360.intarcon.com  
SOFTWARE DE CÁLCULO FRIGORÍFICO

## intarblock PRO Condensado por agua



Nuevos equipos compactos monoblock R-290 de pared diseñados por y para instaladores. Condensados por agua. Para pequeñas y medianas cámaras frigoríficas de refrigeración y conservación. Montaje acaballado sobre la pared de la cámara.

### ESPECIFICACIONES TÉCNICAS

Condensación con entrada de agua entre 5 y 45°C, teniendo un salto de 5K en el intercambiador.	<input checked="" type="checkbox"/>
Válvula solenoide agua para instalación fuera del equipo.	<input checked="" type="checkbox"/>
Condensación con agua glicolada a una temperatura comprendida entre -10 y 5 °C. Incluye válvula presostática automática de agua controlada por la presión de condensación, de accionamiento directo.	<input type="checkbox"/> + 9 % Sobre PVP estándar (pág. 17).

De serie  Opcional

\*Ver características, opcionales, accesorios y dimensiones en página 16 y 17.

Ejemplo de instalación

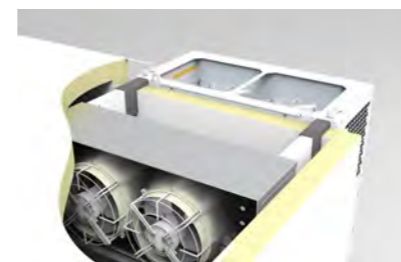

### 230V I+N ~ 50Hz / 400V 3N ~ 50Hz | Media temperatura - Condensado por agua | Compresor hermético | R-290

Refrigerante	Serie / Modelo	Alimentación	Compresor (CV)	Potencia frigorífica / Volumen de cámara, según temperatura de cámara <sup>(1)</sup>						Potencia absorbida nominal (W)	Intens. máxima absorbida (A)	Caudal evap. (m³/h)	Caudal conden. (l/h)	Pérdida de carga (kPa) <sup>(2)</sup>	Conex. hidráulicas	Carga de refrigerante por circuito (g) <sup>(3)</sup>	Peso (kg)	SPL dB(A) <sup>(4)</sup>	PVP (€)
				0 °C		5 °C		10 °C											
				W	m³	W	m³	W	m³										
R-290	MCV-NPD-1008A	230V I+N ~ 50Hz	1/3	648	5	767	8	904	14	400	3,4	750	178	3	1/2"	<150	77	25	2 890,65
	MCV-NPD-1012A	230V I+N ~ 50Hz	1/2	895	8	1 073	13	1 267	23	580	5,8	750	256	3	3/4"	<150	77	31	3 287,55
	MCV-NPD-1018A	230V I+N ~ 50Hz	3/4	1 134	11	1 369	18	1 616	31	700	5,1	750	322	3	3/4"	<150	81	22	3 872,40
	MCV-NPD-2026A	230V I+N ~ 50Hz	1	1 377	14	1 757	25	2 254	47	1 040	9,8	1 350	425	25	3/4"	<150	112	30	4 771,20
	MCV-NPD-2034A	230V I+N ~ 50Hz	1	2 118	24	2 599	42	3 089	69	1 400	13,4	1 350	627	40	3/4"	<150	112	34	5 342,40
	MCV-NPD-2035A	230V I+N ~ 50Hz	2x 3/4	2 357	28	2 793	46	3 272	74	1 350	6,7	1 350	662	3	3/4"	<150	120	25	6 170,85
	MCV-NPD-3052A	400V 3N ~ 50Hz*	2x 1	2 805	47	3 573	62	4 457	120	2 170	9,3	2 800	860	20	3/4"	<150	159	33	6 701,10
	MCV-NPD-3069A	400V 3N ~ 50Hz*	2x 1	4 267	62	5 161	97	6 141	180	2 890	12,9	2 800	1 260	35	1"	<150	159	37	7 430,85

### 230V I+N ~ 50Hz / 400V 3N ~ 50Hz | Baja temperatura - Condensado por agua | Compresor hermético | R-290

Refrigerante	Serie / Modelo	Alimentación	Compresor (CV)	Potencia frigorífica / Volumen de cámara, según temperatura de cámara <sup>(1)</sup>						Potencia absorbida nominal (W)	Intens. máxima absorbida (A)	Caudal evap. (m³/h)	Caudal conden. (l/h)	Pérdida de carga (kPa) <sup>(2)</sup>	Conex. hidráulicas	Carga de refrigerante por circuito (g) <sup>(3)</sup>	Peso (kg)	SPL dB(A) <sup>(4)</sup>	PVP (€)
				-25 °C		-20 °C		-15 °C											
				W	m³	W	m³	W	m³										
R-290	BCV-NPD-1018A	230V I+N ~ 50Hz	3/4	393	1	502	2	626	4	53	5,1	750	147	3	1/2"	<150	81	22	3 991,05
	BCV-NPD-2026A	230V I+N ~ 50Hz	3/4	595	2	749	5	955	9	810	7,5	1 350	229	3	3/4"	<150	112	27	4 114,95
	BCV-NPD-2034A	230V I+N ~ 50Hz	3/4	817	4	1 028	8	1 280	15	1 050	9,4	1 350	308	3	3/4"	<150	112	28	4 679,85
	BCV-NPD-3052A	230V I+N ~ 50Hz	2x 3/4	1 183	9	1 536	16	1 984	30	1 710	15,3	2 800	452	3	3/4"	<150	159	30	6 049,05
	BCV-NPD-3054A	230V I+N ~ 50Hz	1	1 130	8	1 495	16	2 012	30	1 490	15,5	2 800	408	25	3/4"	<150	145	38	5 761,35
	BCV-NPD-3068A	400V 3N ~ 50Hz*	1 1/4	1 419	12	1 864	22	2 468	41	1 970	9,1	2 800	539	35	3/4"	<150	145	40	6 406,05
	BCV-NPD-3069A	400V 3N ~ 50Hz*	2x 3/4	1 641	15	2 092	27	2 622	45	2 220	8,9	2 800	615	3	3/4"	<150	159	30	6 605,55

<sup>(1)</sup> Las prestaciones nominales están referidas al funcionamiento con temperatura de cámara de 0 °C (MT) y -20 °C (BT), con temperatura de entrada/salida de agua de 40/45 °C. Volumen de cámara estimado según condiciones de las bases de cálculo (pág. 12).  
<sup>(2)</sup> Pérdida de carga del condensador en el circuito de agua.  
<sup>(3)</sup> Carga de refrigerante A3 inferior a 500 g, simplificación del cumplimiento RSIF.  
<sup>(4)</sup> Nivel de presión sonora en campo libre, con directividad 1, medido a 10 m de la fuente (valor no vinculante calculado a partir de la potencia sonora).  
 \* Modelo disponible a 230V 50Hz.

PVP condensado por agua: 5% sobre el precio estándar condensado por aire. Ver en página 17.  
 Consultar potencias frigoríficas antes de realizar pedido.

## intartop PRO Condensado por agua



Nuevos equipos compactos monoblock R-290 de techo diseñados por y para instaladores. Condensados por agua. Para pequeñas y medianas cámaras frigoríficas de refrigeración y conservación.

### ESPECIFICACIONES TÉCNICAS

Condensación con entrada de agua entre 5 y 45°C, teniendo un salto de 5K en el intercambiador.	<input checked="" type="checkbox"/>
Válvula solenoide agua para instalación fuera del equipo.	<input checked="" type="checkbox"/>
Condensación con agua glicolada a una temperatura comprendida entre -10 y 5 °C. Incluye válvula presostática automática de agua controlada por la presión de condensación, de accionamiento directo.	<input type="checkbox"/> + 9 % Sobre PVP estándar (pág. 19).

De serie  Opcional

\*Ver características, accesorios y dimensiones en página 18 y 19.

Ejemplo de instalación



### 230V I+N ~ 50Hz / 400V 3N ~ 50Hz | Media temperatura - Condensado por agua | Compresor hermético | R-290

Refrigerante	Serie / Modelo	Alimentación	Compresor (CV)	Potencia frigorífica / Volumen de cámara, según temperatura de cámara <sup>(1)</sup>						Potencia absorbida nominal (W)	Intens. máxima absorbida (A)	Caudal evap. (m³/h)	Caudal conden. (l/h)	Pérdida de carga (kPa) <sup>(2)</sup>	Conex. hidráulicas	Carga de refrigerante por circuito (g) <sup>(3)</sup>	Peso (kg)	SPL dB(A) <sup>(4)</sup>	PVP (€)
				0 °C		5 °C		10 °C											
				W	m³	W	m³	W	m³										
R-290	MCR-NPD-1008A	230V I+N ~ 50Hz	1/3	657	6	776	10	917	17	471	3,4	950	171	3	1/2"	<150	77	25	3 314,85
	MCR-NPD-1012A	230V I+N ~ 50Hz	1/2	964	9	1 140	15	1 339	25	646	5,8	950	254	3	3/4"	<150	77	31	3 530,10
	MCR-NPD-1018A	230V I+N ~ 50Hz	3/4	1 132	12	1 405	21	1 665	34	773	5,1	950	305	3	3/4"	<150	81	22	4 857,30
	MCR-NPD-2026A	230V I+N ~ 50Hz	1	1 712	20	2 042	33	2 560	55	1 149	10,5	1 350	457	25	3/4"	<150	112	30	5 520,90
	MCR-NPD-2034A	230V I+N ~ 50Hz	1	2 207	27	2 690	45	3 264	73	1 541	14,1	1 350	609	40	3/4"	<150	112	34	5 733,00
	MCR-NPD-2035A	230V I+N ~ 50Hz	2x 3/4	2 426	30	2 878	48	3 426	78	1 508	10,4	1 350	639	3	3/4"	<150	120	25	6 539,40
	MCR-NPD-3052A	400V 3N ~ 50Hz*	2x 1	3 485	45	4 060	76	4 940	140	2 294	9,3	2 800	894	20	3/4"	<150	159	33	7 452,90
	MCR-NPD-3069A	400V 3N ~ 50Hz*	2x 1	4 360	60	5 128	97	6 244	175	3 058	12,9	2 800	1 179	35	1"	<150	159	37	8 599,50

### 230V I+N ~ 50Hz / 400V 3N 50Hz | Baja temperatura - Condensado por agua | Compresor hermético | R-290

Refrigerante	Serie / Modelo	Alimentación	Compresor (CV)	Potencia frigorífica / Volumen de cámara, según temperatura de cámara <sup>(1)</sup>						Potencia absorbida nominal (W)	Intens. máxima absorbida (A)	Caudal evap. (m³/h)	Caudal conden. (l/h)	Pérdida de carga (kPa) <sup>(2)</sup>	Conex. hidráulicas	Carga de refrigerante por circuito (g) <sup>(3)</sup>	Peso (kg)	SPL dB(A) <sup>(4)</sup>	PVP (€)
				-25 °C		-20 °C		-15 °C											
				W	m³	W	m³	W	m³										
R-290	BCR-NPD-1018A	230V I+N ~ 50Hz	3/4	426	1	511	2	664	5	505	5,1	950	169	3	1/2"	<150	81	22	3 726,45
	BCR-NPD-2026A	230V I+N ~ 50Hz	3/4	622	2	794	5	990	10	781	8,2	1 350	262	3	3/4"	<150	112	27	4 579,05
	BCR-NPD-2034A	230V I+N ~ 50Hz	3/4	848	5	1 078	9	1 322	16	970	10,1	1 350	355	3	3/4"	<150	112	28	5 200,65
	BCR-NPD-3052A	230V I+N ~ 50Hz	2x 1 1/4	1 228	9	1 580	17	1 940	29	1 554	15,3	2 800	521	3	3/4"	<150	159	30	6 472,20
	BCR-NPD-3054A	230V I+N ~ 50Hz	1	1 117	8	1 491	15	1 923	28	1 367	15,5	2 800	460	25	3/4"	<150	145	38	6 163,50
	BCR-NPD-3068A	400V 3N ~ 50Hz*	1 1/4	1 460	12	1 942	24	2 440	40	1 673	9,1	2 800	617	35	3/4"	<150	145	40	7 690,20
	BCR-NPD-3069A	400V 3N ~ 50Hz*	2x 1 1/2	1 634	15	2 078	26	2 544	43	1 972	8,9	2 800	691	3	3/4"	<150	159	30	7 954,80

<sup>(1)</sup> Las prestaciones nominales están referidas al funcionamiento con temperatura de cámara de 0 °C (MT) y -20 °C (BT), con temperatura de entrada/salida de agua de 40/45 °C. Volumen de cámara estimado según condiciones de las bases de cálculo (pág. 12).  
<sup>(2)</sup> Pérdida de carga del condensador en el circuito de agua.  
<sup>(3)</sup> Carga de refrigerante A3 inferior a 500 g, simplificación del cumplimiento RSIF.  
<sup>(4)</sup> Nivel de presión sonora en campo libre, con directividad 1, medido a 10 m de la fuente (valor no vinculante calculado a partir de la potencia sonora).  
 \* Modelo disponible a 230V 50Hz.

PVP condensado por agua: 5% sobre el precio estándar condensado por aire. Ver en página 19.  
 Consultar potencias frigoríficas antes de realizar pedido.

## intartop



Equipos ultra compactos monoblocks diseñados para minicámaras frigoríficas de refrigeración y congelación, montaje en techo de la cámara.

### ESPECIFICACIONES TÉCNICAS

Carga de refrigerante R-290.	■
Compresor hermético alternativo.	■
Presostato de alta y baja presión.	■
Expansión por válvula termostática.	■
Protección magnetotérmica.	■
Desescarche por inyección de gas caliente.	■
Bandeja de condensados en acero inoxidable.	■
Evaporación automática de condensados.	■
Luz led de cámara con micro-interruptor de puerta.	■
Cajón de evaporación en panel sándwich de 50 mm de espuma de poliuretano, revestido interiormente con chapa de acero prelacado.	■
Regulación electrónica multifunción.	■
Tratamiento anticorrosión en epoxi de la batería de evaporación.	□ + 6 %

■ De serie □ Opcional

### ESQUEMA DE INSTALACIÓN

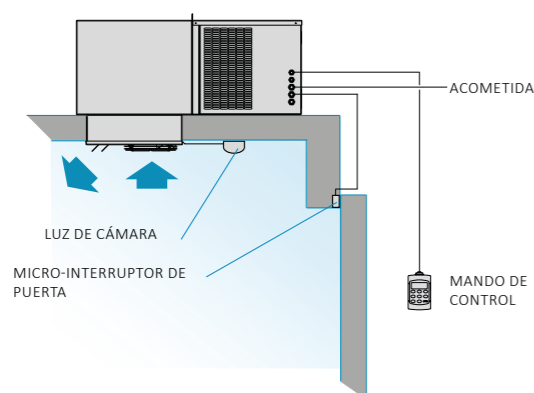

### Controlador electrónico

La regulación electrónica XW270K, de serie en nuestros equipos compactos comerciales de techo incluye las siguientes funciones:



- Mando multifunción de control digital a distancia.
- Control de temperatura con registro de temperaturas máxima y mínima.
- Función Jet Cool de enfriamiento rápido.
- Modo de funcionamiento nocturno.

### 230V I+N ~ 50Hz | Media temperatura | Compresor hermético | R-290

Refrigerante	Serie / Modelo Axial	Alimentación	Compresor (CV)	Potencia frigorífica / Volumen de cámara, según temperatura de cámara <sup>(1)</sup>						Potencia absorbida nominal (W)	Intens. máxima absorbida (A)	Caudal evap. (m³/h)	Carga de refrigerante (g) <sup>(2)</sup>	Peso (kg)	SPL dB(A) <sup>(3)</sup>	PVP (€)
				0 °C		5 °C		10 °C								
				W	m³	W	m³	W	m³							
R-290	MCR-ND-0009A	230V I+N ~ 50Hz	1/3	670	5	780	7	900	12	390	3,6	300	<100	63	29	2 380
	MCR-ND-1012A	230V I+N ~ 50Hz	1/2	1 060	9	1 240	15	1 435	27	530	3,4	600	<100	73	29	2 889
	MCR-ND-1017A	230V I+N ~ 50Hz	3/4	1 370	14	1 585	21	1 815	36	680	4,5	600	<150	73	31	3 221
	MCR-ND-2026A	230V I+N ~ 50Hz	1	1 850	21	2 200	34	2 577	58	980	5,9	1 150	<150	96	35	4 301
	MCR-ND-2034A	230V I+N ~ 50Hz	1	2 240	27	2 650	43	2 995	70	1 350	9,0	1 150	<200	96	35	5 409

### 230V I+N ~ 50Hz | Baja temperatura | Compresor hermético | R-290

Refrigerante	Serie / Modelo	Alimentación	Compresor (CV)	Potencia frigorífica / Volumen de cámara, según temperatura de cámara <sup>(1)</sup>						Potencia absorbida nominal (W)	Intens. máxima absorbida (A)	Caudal evap. (m³/h)	Carga de refrigerante (g) <sup>(2)</sup>	Peso (kg)	SPL dB(A) <sup>(3)</sup>	PVP (€)
				-25 °C		-20 °C		-15 °C								
				W	m³	W	m³	W	m³							
R-290	BCR-ND-0014A	230V I+N ~ 50Hz	3/4	385	1	460	2	550	4	390	3,3	300	<100	65	29	2 803
	BCR-ND-1017A	230V I+N ~ 50Hz	3/4	540	2	660	5	800	8	490	3,5	600	<100	73	29	3 148
	BCR-ND-1028A	230V I+N ~ 50Hz	1 1/4	770	4	925	9	1 100	15	730	6,0	600	<150	80	31	3 449
	BCR-ND-2034A	230V I+N ~ 50Hz	3/4	985	7	1 215	14	1 475	25	990	9,3	1 150	<200	96	34	4 236

<sup>(1)</sup> Las prestaciones nominales están referidas al funcionamiento con temperatura de cámara de 0 °C (MT) y 20 °C (BT), y temperatura exterior de 35 °C. Volumen de cámara estimado según condiciones de las bases de cálculo (pág. 12).

<sup>(2)</sup> Carga de refrigerante A3 inferior a 500 g, simplificación del cumplimiento RSIF.

<sup>(3)</sup> Nivel de presión sonora del condensador en campo libre, con directividad 1, medido a 10 m de la fuente (valor no vinculante calculado a partir de la potencia sonora).

### DIMENSIONES

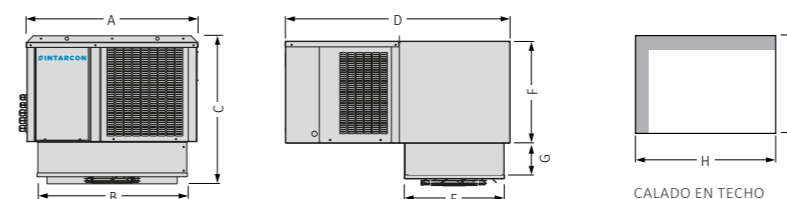

Dimensiones (mm)	A	B	C	D	E	F	G	H	I
Serie 0	600	430	480	790	375	330	100	435	385
Serie 1	665	582	574	850	379	385	135	590	385
Serie 2	835	756	677	850	379	469	135	760	385

CLIENT360  
client360.intarcon.com  
SOFTWARE DE CÁLCULO FRIGORÍFICO



## intartop A2L



Equipos ultra compactos monoblocks diseñados para minicámaras frigoríficas de refrigeración y congelación, montaje en techo de la cámara.

### ESPECIFICACIONES TÉCNICAS

Carga de R-455A.	<input checked="" type="checkbox"/>
Compresor hermético alternativo.	<input checked="" type="checkbox"/>
Presostato de alta presión.	<input checked="" type="checkbox"/>
Expansión por válvula termostática.	<input checked="" type="checkbox"/>
Protección magnetotérmica.	<input checked="" type="checkbox"/>
Desescarche por inyección de gas caliente.	<input checked="" type="checkbox"/>
Bandeja de condensados en acero inoxidable y evaporación automática de condensados.	<input checked="" type="checkbox"/>
Luz de cámara led y cable interruptor de puerta.	<input checked="" type="checkbox"/>
Cajón de evaporación en panel sándwich de 50 mm de espuma de poliuretano, revestido interiormente con chapa de acero prelacado.	<input checked="" type="checkbox"/>
Regulación electrónica multifunción.	<input checked="" type="checkbox"/>
Cambio a alimentación 400V 3N 50Hz.	<input type="checkbox"/> + 5 %
Ventilador centrífugo de impulsión horizontal.	<input type="checkbox"/> + 15 %
Ventilador centrífugo de impulsión vertical.	<input type="checkbox"/> + 15 %
Tratamiento anticorrosión en epoxi de la batería de evaporación.	<input type="checkbox"/> + 6 %
Tratamiento anticorrosión de poliuretano de la batería de condensación.	<input type="checkbox"/> + 4 %
Control de tensión.	<input type="checkbox"/> + 195 €
Maestro-esclavo (alternativo + simultáneo).	<input type="checkbox"/> + 85 €

De serie  Opcional

### ESQUEMA DE INSTALACIÓN

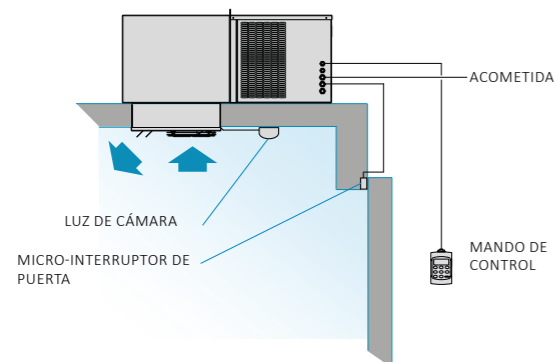

### Ejemplo de instalación



### Controlador electrónico

Los equipos intartop incorporan de serie el avanzado controlador electrónico XW270K.



- ▣ Mando multifunción de control digital a distancia.
- ▣ Control de temperatura con registro de temperaturas máxima y mínima.
- ▣ Función Jet Cool de enfriamiento rápido.
- ▣ Modo de funcionamiento nocturno.

### Accesorios equipos CR-NN

- ▣ Tolva de adaptación a conducto circular (+ 131 €).
- ▣ Compuerta antirretorno (+ 72 €).
- ▣ Micro-interruptor de puerta (+ 67 €).

### 230V I+N ~ 50Hz | Media temperatura | Compresor hermético | R-455A

Refrigerante	Serie / Modelo Axial	Alimentación	Compresor (CV)	Potencia frigorífica / Volumen de cámara, según temperatura de cámara <sup>(1)</sup>						Potencia abs. nominal (W)	Intens. máx. abs. (A)	Caudal evap. (m³/h)	Caudal cond. (m³/h)	PSD (Pa) <sup>(2)</sup>	Carga de refriger. (kg)	Peso (kg)	SPL dB(A) <sup>(3)</sup>	PVP (€)
				0 °C		5 °C		10 °C										
				W	m³	W	m³	W	m³									
R-455A	MCR-NN-0010A	230V I+N ~ 50Hz	1/3	691	5	821	9	950	15	480	7,1	400	375	80	<1,0	63	34	2 200
	MCR-NN-1016A	230V I+N ~ 50Hz	3/4	1 095	10	1 286	17	1 489	28	741	9,4	575	575	80	<1,0	83	34	2 811
	MCR-NN-2024A	230V I+N ~ 50Hz	1	1 850	20	2 210	34	2 592	56	1 100	14,4	1 050	1 000	120	<1,5	97	35	3 908
	MCR-NN-2026A	230V I+N ~ 50Hz*	1 1/2	1 964	22	2 340	37	2 732	59	1 201	15,1	1 050	1 000	120	<2,0	97	36	4 373

### 230V I+N ~ 50Hz | Baja temperatura | Compresor hermético | R-455A

Refrigerante	Serie / Modelo	Alimentación	Compresor (CV)	Potencia frigorífica / Volumen de cámara, según temperatura de cámara <sup>(1)</sup>						Potencia abs. nominal (W)	Intens. máx. abs. (A)	Caudal evap. (m³/h)	Caudal cond. (m³/h)	PSD (Pa) <sup>(2)</sup>	Carga de refriger. (kg)	Peso (kg)	SPL dB(A) <sup>(3)</sup>	PVP (€)
				-25 °C		-20 °C		-15 °C										
				W	m³	W	m³	W	m³									
R-455A	BCR-NN-0018A	230V I+N ~ 50Hz	3/4	378	1	464	2	574	3	500	8,4	400	375	80	<0,5	73	31	2 788
	BCR-NN-1034A	230V I+N ~ 50Hz	1 1/2	672	3	801	5	1 013	10	965	12,6	575	575	80	<1,0	84	33	3 422
	BCR-NN-2055A	230V I+N ~ 50Hz*	2	1 186	9	1 475	15	1 813	26	1 389	19,2	1 050	1 000	120	<1,5	104	41	4 572
	BCR-NN-3068A	230V I+N ~ 50Hz*	3	1 617	15	1 965	24	2 363	38	1 928	22,9	1 300	1 500	140	<1,5	144	44	5 748

<sup>(1)</sup> Las prestaciones nominales están referidas al funcionamiento con temperatura de cámara de 0 °C (MT) y -20 °C (BT), y temperatura exterior de 35 °C. <sup>(2)</sup> Presión estática disponible de condensación.

<sup>(3)</sup> Nivel de presión sonora del condensador en campo libre, con directividad 1, medido a 10 m de la fuente (valor no vinculante calculado a partir de la potencia sonora).

\* Unidades disponibles en tensión 400V 3N 50Hz.

### DIMENSIONES

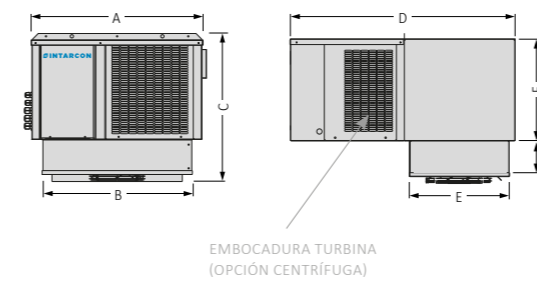

Dimensiones (mm)	A	B	C	D	E	F	G	H	I	Embocadura turbina	Tolva
Serie 0	600	430	480	790	375	330	100	435	385	185 x 115	Ø 150
Serie 1	665	582	574	850	379	385	135	590	385	185 x 115	Ø 150
Serie 2	835	756	677	850	379	469	135	760	385	230 x 130	Ø 200
Serie 3	925	843	680	1 070	454	485	145	850	460	266 x 236	Ø 250

### Marcos de montaje

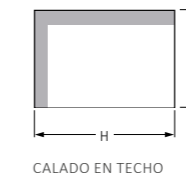

### Conductos de extracción de aire

Dimensiones recomendadas para conductos de descarga en chapa, PVC, o panel de lana de vidrio, de 20 m de longitud (cada codo a 90° equivale a 5 m de longitud). Para conductos flexibles o semirígidos se recomienda utilizar una dimensión mayor.

- ▣ Serie 0: 200 x 150 mm o Ø 150 mm
- ▣ Serie 1: 200 x 200 mm o Ø 150 mm
- ▣ Serie 2: 250 x 150 mm o Ø 200 mm
- ▣ Serie 3: 200 x 200 mm o Ø 250 mm

CLIENT360  
client360.intarcon.com  
SOFTWARE DE CÁLCULO FRIGORÍFICO



## intartop PRO



Nuevos equipos compactos monoblock R-290 de techo diseñados por y para instaladores. Para pequeñas y medianas cámaras frigoríficas de refrigeración y conservación.

### ESPECIFICACIONES TÉCNICAS

Carga de refrigerante R-290.	De serie
Circuito frigorífico independiente por compresor.	De serie
Compresores herméticos montados sobre railes para disminuir vibraciones.	De serie
Batería condensadora en microcanal con tratamiento de pintura poliéster.	De serie
Ventiladores del evaporador AC y EC en condensador.	De serie
Presostato de alta presión.	De serie
Bandeja de condensados en inoxidable, extraíble para limpieza, y serpentín de cobre con pintura epoxi.	De serie
Manta filtrante en rejilla de aspiración lavable.	De serie
Resistencia de desagüe en modelos de BT.	De serie
Tampón desmontable con parte fija, para paso de tubos y cableado de 80 mm.	De serie
Acceso a cuadro eléctrico con registro abatible.	De serie
Desescarche por gas caliente.	De serie
Expansión por válvula termostática.	De serie
Chapas de aluminio recubiertas de film para protección en transporte en evaporador.	De serie
Regulación electrónica multifunción con mando remoto y 5 m de manguera libre de halógenos.	De serie
Luz led de cámara.	De serie
Ventilador radial con posibilidad de impulsión vertical u horizontal (solo en equipos estándar condensados por aire).	De serie + 10 %
Adaptación a bitémpero.	De serie + 10 %
Base macho y clavija hembra de conexión industrial.	De serie + 80 €
Control de tensión (modelos monofásicos).	De serie + 195 €
Control de tensión y fallo de fase (modelos trifásicos).	De serie + 259 €
Cambio alimentación a 230V 50Hz (modelo trifásicos).	De serie + 8 %
Resistencia de desagüe (para temperatura de cámara < 0 °C en modelos de MT).	De serie + 91 €
Maestro-esclavo (alternativo + simultáneo).	De serie + 85 €

De serie Opcional



### Adaptación a distintos espesores de techo

Los nuevos equipos compactos de techo comerciales se suministran con el cajón del ventilador de evaporador aparte y el montaje se realizará de manera telescópica, adaptándose así a paneles de techo de 80 a 150 mm de espesor.

### Controlador electrónico

Los equipos intartop PRO incorporan de serie el avanzado controlador electrónico XM670K.



- Mando multifunción de control digital a distancia.
- Reloj interno para programación de ciclos de ahorro de energía y desescarches.
- Posibilidad de interconexión y sincronización de hasta 8 equipos en red LAN, gestionados con un solo mando de control.

### Accesorios equipos CR-NPD

- Tolva de adaptación a conducto circular en impulsión vertical (+ 131 €).
- Kit de conducción de aire (+ 124 €).
- Compuerta antirretorno (+ 72 €).
- Micro-interruptor de puerta (+ 67 €).
- Manguera eléctrica de acometida de 5 m (+ 2 %).

### ESQUEMA DE INSTALACIÓN

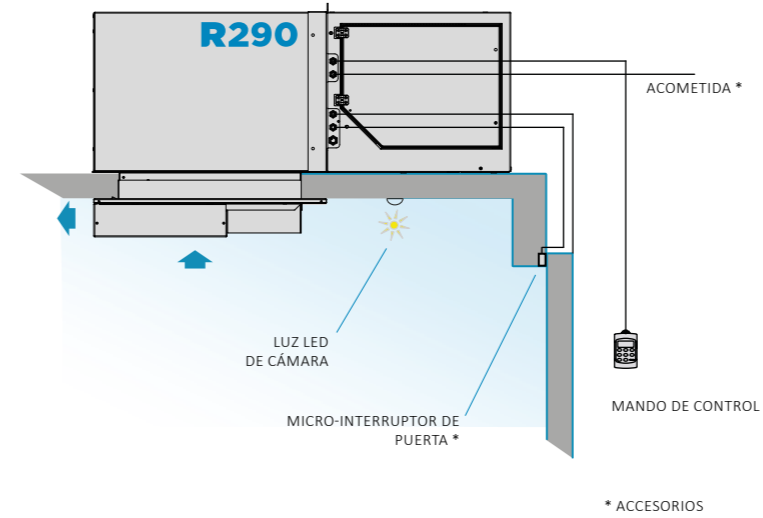

### Ventilador radial (opcional)

Sustitución del ventilador de condensación estándar por uno radial de impulsión horizontal (embocadura horizontal circular) / vertical (embocadura vertical rectangular).



### Cajón conducción de entrada de aire exterior (opcional)

Cajón para conducción de entrada de aire exterior al condensador, con embocadura horizontal circular.



### Condensación con agua (opcional)

Condensación con agua a una temp. comprendida entre 5 °C / 50 °C o -10 °C / 5 °C (solo en modelos de BT).



### 230V I+N ~ 50Hz / 400V 3N ~ 50Hz | Media temperatura | Compresor hermético | R-290

Refrigerante	Serie / Modelo	Alimentación	Compresor (CV)	Potencia frigorífica / Volumen de cámara, según temperatura de cámara <sup>(1)</sup>						Potencia absorbida nominal (W)	Intens. máxima absorbida (A)	Caudal evap. (m³/h)	Caudal conden. [Opc. radial] (m³/h)	PSD (Pa) <sup>(2)</sup>	Carga de refriger. por circuito (g) <sup>(3)</sup>	Peso (kg)	SPL dB(A) <sup>(4)</sup>	PVP (€)
				0 °C		5 °C		10 °C										
				W	m³	W	m³	W	m³									
R-290	MCR-NPD-1008A	230V I+N ~ 50Hz	1/3	737	6	867	10	1010	17	471	4,1	950	1450	100	< 150	82	43	3157
	MCR-NPD-1012A	230V I+N ~ 50Hz	1/2	1000	9	1184	15	1386	25	646	6,5	950	1450	100	< 150	82	43	3362
	MCR-NPD-1018A	230V I+N ~ 50Hz	3/4	1275	12	1506	21	1757	34	773	5,8	950	1450	100	< 150	86	43	4626
	MCR-NPD-2026A	230V I+N ~ 50Hz	1	1794	20	2149	33	2560	55	1149	11,9	1350	1600	100	< 500	117	42	5258
	MCR-NPD-2034A	230V I+N ~ 50Hz	1	2332	27	2747	45	3220	73	1541	15,5	1350	1600	100	< 500	117	42	5460
	MCR-NPD-2035A	230V I+N ~ 50Hz	2x 3/4	2516	30	2932	48	3386	78	1508	11,8	1350	1600	100	< 150	125	42	6228
	MCR-NPD-3052A	400V 3N ~ 50Hz*	2x 1	3485	45	4207	76	4949	140	2294	9,3	2800	3000	100	< 150	164	45	7098
	MCR-NPD-3069A	400V 3N ~ 50Hz*	2x 1	4360	60	5177	97	6045	175	3058	12,9	2800	3000	100	< 500	164	45	8190

### 230V I+N ~ 50Hz / 400V 3N 50Hz | Baja temperatura | Compresor hermético | R-290

Refrigerante	Serie / Modelo	Alimentación	Compresor (CV)	Potencia frigorífica / Volumen de cámara, según temperatura de cámara <sup>(1)</sup>						Potencia absorbida nominal (W)	Intens. máxima absorbida (A)	Caudal evap. (m³/h)	Caudal conden. [Opc. radial] (m³/h)	PSD (Pa) <sup>(2)</sup>	Carga de refriger. por circuito (g) <sup>(3)</sup>	Peso (kg)	SPL dB(A) <sup>(4)</sup>	PVP (€)
				-25 °C		-20 °C		-15 °C										
				W	m³	W	m³	W	m³									
R-290	BCR-NPD-1018A	230V I+N ~ 50Hz	3/4	469	1	594	3	725	5	596	5,8	950	1450	100	< 150	86	43	3549
	BCR-NPD-2026A	230V I+N ~ 50Hz	3/4	720	3	903	7	1126	12	950	8,9	1350	1600	100	< 500	117	41	4361
	BCR-NPD-2034A	230V I+N ~ 50Hz	3/4	992	6	1213	11	1470	19	1190	10,8	1350	1600	100	< 500	117	41	4953
	BCR-NPD-3052A	230V I+N ~ 50Hz	2x 3/4	1340	11	1692	19	2108	32	1895	18,3	2800	3000	100	< 150	164	44	6164
	BCR-NPD-3054A	230V I+N ~ 50Hz	1	1293	10	1689	19	2164	34	1705	18,1	2800	3000	100	< 500	150	45	5870
	BCR-NPD-3068A	400V 3N ~ 50Hz*	1 1/4	1574	14	2107	27	2605	44	2240	11,9	2800	3000	100	< 500	150	44	7324
	BCR-NPD-3069A	400V 3N ~ 50Hz*	2x 1 1/2	1814	18	2258	30	2743	48	2353	11,9	2800	3000	100	< 150	164	46	7576

### DIMENSIONES

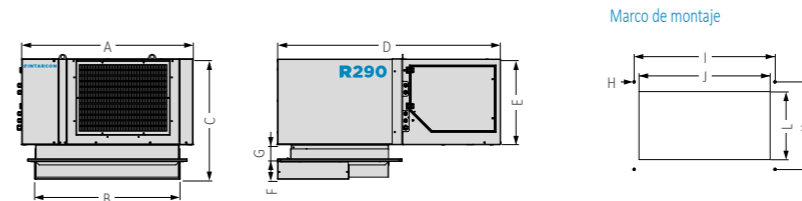

Dimensiones (mm)	A*	B	C	D*	E	F	G	H	I	J	K	L	Embocadura turbina (horizontal / vertical)
Serie 1	695	532	687	1145	490	117	De 80 a 150	4 x Ø 13	580	535	615	503	Ø 300 / 330x250
Serie 2	995	832	687	1275	490	117	De 80 a 150	4 x Ø 13	880	835	680	568	Ø 300 / 330x250
Serie 3	1245	1082	687	1275	490	117	De 80 a 150	4 x Ø 13	1130	1085	680	568	Ø 350 / 430x250

\* El ancho de la unidad con el opcional ventilador radial pasará a ser de: 1045 mm (CR-1), 1345 mm (CR-2), 1595 mm (CR-3), y el nivel de presión sonora cambiará ligeramente respecto al valor facilitado para el equipo axial. El largo con el opcional cajón de conducción pasará a ser de: 1310 mm (CR-1) y 1440 mm (CR-2 / CR-3).

<sup>(1)</sup> Las prestaciones nominales están referidas al funcionamiento con temperatura de cámara de 0 °C (MT) y -20 °C (BT), y temperatura exterior de 35 °C. <sup>(2)</sup> Presión estática disponible de condensación.

<sup>(3)</sup> Carga de refrigerante A3 inferior a 500 g, simplificación del cumplimiento RSIF.

<sup>(4)</sup> Nivel de presión sonora del condensador en campo libre, con directividad 1, medido a 10 m de la fuente (valor no vinculante calculado a partir de la potencia sonora).

\* Modelo disponible a 230V 50Hz.

### Fácil instalación

El evaporador se envía en un bulto independiente a la parte condensadora, de manera que facilita el montaje del equipo en la cámara frigorífica.

## Sigilus

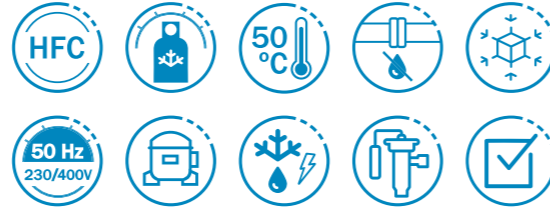

Equipos semicompactos para cámaras frigoríficas de pequeño y mediano tamaño, formados por una unidad condensadora silenciosa y una unidad evaporadora de bajo perfil, plafón de doble flujo o tipo cúbico.

### ESPECIFICACIONES TÉCNICAS

Aislamiento acústico de compresor solo en equipos que son de serie trifásicos (compresor DANFOSS).	<input checked="" type="checkbox"/>
Amplia superficie de condensación en L (recta en series 0 y 1).	<input checked="" type="checkbox"/>
Ventiladores de condensación de baja velocidad.	<input checked="" type="checkbox"/>
Control de condensación proporcional (opcional en versiones -N). Control por variación de velocidad (excepto serie 0).	<input checked="" type="checkbox"/> + 327 €
Presostatos de alta y baja presión.	<input checked="" type="checkbox"/>
Silenciador de descarga (a partir de 1 CV) y resistencia de cárter.	<input checked="" type="checkbox"/>
Recipiente de líquido.	<input checked="" type="checkbox"/>
Precarga de refrigerante para hasta 10 m de tubería.	<input checked="" type="checkbox"/>
Válvula termostática y válvula solenoide integradas.	<input checked="" type="checkbox"/>
Desescarche por resistencia eléctrica (excepto serie ASF).	<input checked="" type="checkbox"/>
Bandeja de condensados.	<input checked="" type="checkbox"/>
Conexiones de tipo Flare (hasta 1/2"-3/4") y válvulas de servicio.	<input checked="" type="checkbox"/>
Protección magnetotérmica.	<input checked="" type="checkbox"/>
Regulación electrónica multifunción con mando a distancia y control de condensación digital.	<input checked="" type="checkbox"/>
Inyección de líquido en modelos de baja temperatura con R-449A.	<input checked="" type="checkbox"/>
Cambio a alimentación 400V 3N 50Hz.	<input type="checkbox"/> + 5 %
Rejilla exterior de protección de la batería.	<input type="checkbox"/> + 121 €
Separador de aceite.	<input type="checkbox"/> + 768 €
Recubrimiento anticorrosión de batería evaporador.	<input type="checkbox"/> + 6 %
Recubrimiento anticorrosión de batería condensador.	<input type="checkbox"/> + 4 %
Mando multifunción de mayor tamaño.	<input type="checkbox"/> + 198 €

De serie  Opcional

### ESQUEMA DE INSTALACIÓN

Distancia vertical máxima entre unidades de 15 m en caso de que la unidad condensadora esté situada a mayor altura que la unidad evaporadora, y de 6 m en caso contrario.  
\*Pendiente mínima del tubo de desagüe del 20 % para modelos de baja temperatura.

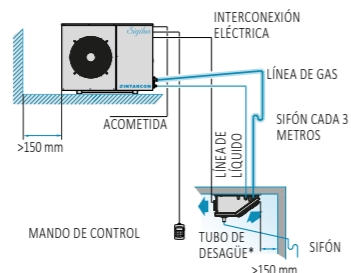

### Controlador electrónico

Los equipos Sigilus incorporan de serie el avanzado controlador electrónico XM670K.



- Mando multifunción de control digital a distancia.
- Reloj interno para programación de ciclos de ahorro de energía y desescarches.
- Posibilidad de interconexión y sincronización de hasta 8 equipos en red LAN, gestionados con un solo mando de control.

### Triple insonorización acústica

Las unidades condensadoras de la serie Sigilus incorporan una triple insonorización acústica:

- Compartimento del compresor insonorizado y separado del flujo de aire.
- Compresor hermético en camisa acústica (solo para compresores que son trifásicos de serie (Danfoss)) y silenciador de descarga.
- Ventiladores silenciosos de baja velocidad sobre estructura antivibratoria.

### Control de condensación proporcional

Incorporamos en la serie Sigilus (opcional para las unidades con evaporador de bajo perfil) un control de condensación proporcional por variación de velocidad para funcionamientos prolongados con baja temperatura exterior.

## CLIENT360

client360.intarcon.com  
SOFTWARE DE CÁLCULO FRIGORÍFICO



### 230V I+N ~ 50Hz / 400V 3N ~ 50Hz | Media temperatura | Compresor hermético | R-134a / R-449A

Refrigerante	Serie / Modelo	Alimentación	Compresor (CV)	Potencia frigorífica / Volumen cámara, según temperatura de cámara (1)								Potencia absorb. nominal (W)	Intens. máx. absorb. (A)	Vent. evap.	Caudal evapo. (m³/h)	Caudal cond. (m³/h)	Conexión frigorífica Liq-Gas	Carga refrig. (kg) (2)	Peso (kg)	SPL dB(A) (3)	PVP (€)
				-5 °C		0 °C		5 °C		10 °C											
				W	m³	W	m³	W	m³	W	m³										
R-134a	MSF-NY-00010A	230V I+N ~ 50Hz	3/8	497	2,9	637	5,0	788	8,8	945	13	410	4,2	1x Ø 172	300	350	1/4"-3/8"	<1,5	46+12	28	3 007
	MSF-NY-00015A	230V I+N ~ 50Hz	1/2	653	3,6	832	7,4	1004	11	1188	16	510	5,2	1x Ø 172	300	350	1/4"-3/8"	<1,5	49+12	29	3 315
	MSF-NY-11015A	230V I+N ~ 50Hz	1/2	805	4,7	1031	10	1296	14	1582	28	560	5,6	1x Ø 200	550	1700	1/4"-1/2"	<2,0	57+16	34	3 470
	MSF-NY-11026A	230V I+N ~ 50Hz	3/4	1076	9,0	1412	16	1738	25	2084	40	800	9,2	1x Ø 200	550	1700	1/4"-1/2"	<2,0	65+16	34	4 213
	MSF-NY-12033A	230V I+N ~ 50Hz	1	1475	13	1859	20	2289	35	2741	57	1020	9,7	2x Ø 200	1050	1700	1/4"-5/8"	<2,0	67+24	34	5 264
	MSF-NY-12053A	230V I+N ~ 50Hz*	1 1/2	1811	22	2347	33	2872	50	3439	79	1420	12,3	2x Ø 200	1050	1700	1/4"-5/8"	<2,0	77+24	35	6 172
	MSF-NY-13074A	230V I+N ~ 50Hz*	2	2772	30	3528	50	4363	76	5229	125	1940	17,2	3x Ø 254	1725	1700	1/4"-3/4"	<3,5	79+45	37	6 720
	MSF-NY-23086A	400V 3N ~ 50Hz	4	3355	39	4384	65	5376	108	6437	160	2180	14,1	3x Ø 254	1725	3700	3/8"-7/8"	<4,5	96+45	38	7 482
	MSF-NY-24108A	400V 3N ~ 50Hz	5	4347	58	5649	90	6920	138	8316	220	2830	18,2	4x Ø 300	3100	3700	3/8"-7/8"	<5,0	98+45	35	8 796
	MSF-NY-24136A	400V 3N ~ 50Hz	6 1/2	5486	75	6899	110	8363	150	9949	280	3550	22,2	4x Ø 300	3100	3700	3/8"-1 1/8"	<5,5	101+55	34	10 992
MSF-NY-34171A	400V 3N ~ 50Hz	8	6080	88	7613	130	9240	200	10978	350	4160	25,2	4x Ø 300	3100	4000	3/8"-1 1/8"	<5,5	140+55	40	12 526	
R-449A	MSF-NG-0008A	230V I+N ~ 50Hz	1/3	611	2,9	759	5,0	915	8,8	1103	13	430	5,1	1x Ø 172	300	350	1/4"-3/8"	<1,5	47+12	29	2 832
	MSF-NG-0010A	230V I+N ~ 50Hz	3/8	739	3,6	894	6,1	1056	10	1254	15	530	4,8	1x Ø 172	300	350	1/4"-3/8"	<1,5	49+12	29	3 123
	MSF-NG-0012A	230V I+N ~ 50Hz	1/2	818	4,7	981	7,4	1153	12	1358	21	630	5,6	1x Ø 172	300	350	1/4"-3/8"	<1,5	50+12	29	3 270
	MSF-NG-1014A	230V I+N ~ 50Hz	1/2	882	8,0	1095	12	1322	20	1585	34	770	6,5	1x Ø 200	550	1700	1/4"-1/2"	<2,0	59+16	34	3 645
	MSF-NG-1016A	230V I+N ~ 50Hz	5/8	972	10	1210	15	1462	24	1759	40	810	7,4	1x Ø 200	550	1700	1/4"-1/2"	<2,0	67+16	34	3 971
	MSF-NG-1018A	230V I+N ~ 50Hz	3/4	1397	12	1649	19	1915	28	2245	45	940	8,7	1x Ø 200	550	1700	1/4"-1/2"	<2,0	68+16	34	4 413
	MSF-NG-2024A	230V I+N ~ 50Hz	1	1513	14	1958	22	2420	35	2958	57	1260	11,1	2x Ø 200	1050	1700	1/4"-1/2"	<2,5	82+24	34	4 961
	MSF-NG-2026A	230V I+N ~ 50Hz*	1 1/4	1712	16	2147	25	2611	39	3157	64	1440	11,5	2x Ø 200	1050	1700	1/4"-1/2"	<2,5	83+24	34	5 182
	MSF-NG-2034A	230V I+N ~ 50Hz*	1 1/2	2120	21	2606	33	3117	50	3730	79	1830	16,1	2x Ø 200	1050	1700	1/4"-5/8"	<2,5	83+24	35	5 493
	MSF-NG-3038A	400V 3N ~ 50Hz	1 3/4	2770	29	3394	46	4078	71	4894	112	1890	8,1	3x Ø 254	1725	3200	1/4"-5/8"	<3,0	82+45	29	6 218
MSF-NG-4048A	400V 3N ~ 50Hz	2	3368	39	4231	62	5158	92	6225	145	2340	9,6	3x Ø 254	1725	3700	3/8"-3/4"	<4,5	84+45	26	6 756	
MSF-NG-4054A	400V 3N ~ 50Hz	2 1/2	3792	47	4671	70	5640	105	6780	160	2540	10,1	3x Ø 254	1725	3700	3/8"-3/4"	<4,5	85+45	26	7 217	

### 230V I+N ~ 50Hz / 400V 3N ~ 50Hz | Baja temperatura | Compresor hermético | R-449A / R-452A

Refrigerante	Serie / Modelo	Alimentación	Compresor (CV)	Potencia frigorífica / Volumen cámara, según temperatura de cámara (1)						Potencia absorb. nominal (W)	Intens. máx. absorb. (A)	Vent. evap.	Caudal evapo. (m³/h)	Caudal cond. (m³/h)	Conexión frigorífica Liq-Gas	Carga refrig. (kg) (2)	Peso (kg)	SPL dB(A) (3)	PVP (€)
				-25 °C		-20 °C		-15 °C											
				W	m³	W	m³	W	m³										
R-449A	BSF-NG-1026A	230V I+N ~ 50Hz	3/4	763	3,2	952	7,0	1155	13	820	8,5	1x Ø 200	550	1700	1/4"-1/2"	<2,0	67+16	34	4 465
	BSF-NG-2034A	230V I+N ~ 50Hz	1 1/4	930	3,9	1107	8,1	1437	15	1180	11,3	2x Ø 200	1050	1700	1/4"-1/2"	<2,0	83+16	34	4 737
	BSF-NG-2055A	230V I+N ~ 50Hz*	1 3/4	1260	9,0	1710	16	2190	30	1700	17,5	2x Ø 200	1050	1700	1/4"-5/8"	<2,5	85+24	36	5 800
	BSF-NG-2075A	230V I+N ~ 50Hz*	2 1/2	1655	13	2130	22	2625	38	2100	25,5	2x Ø 200	1050	1700	1/4"-5/8"	<3,5	90+24	37	6 113
	BSF-NG-3075A	230V I+N ~ 50Hz*	2 1/2	1755	14	2450	27	3080	48	2300	26,3	3x Ø 254	1725	1700	1/4"-5/8"	<3,5	90+45	37	6 554
R-452A	BSF-NB-4096A	400V 3N ~ 50Hz	3 1/2	1847	19	2732	39	3504	68	2480	12,0	3x Ø 254	1725	3700	3/8"-3/4"	<4,5	97+45	39	8 495
	BSF-NB-4108A	400V 3N ~ 50Hz	4	2513	29	3262	50	3990	78	2820	14,6	3x Ø 254	1725	3700	3/8"-7/8"	<5,0	97+45	37	9 195
	BSF-NB-4136A	400V 3N ~ 50Hz	5	2973	37	3715	61	4572	100	3640	16,8	3x Ø 254	1725	3700	3/8"-7/8"	<5,0	100+45	32	9 919

### DIMENSIONES

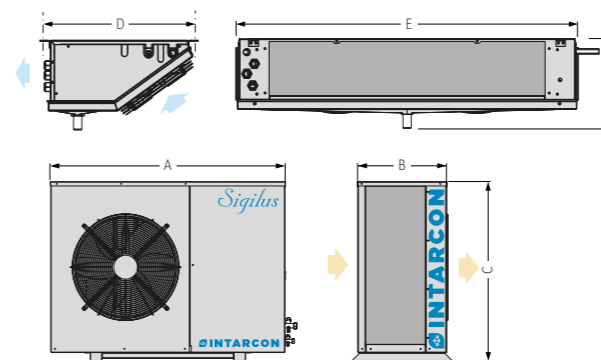

Dimensiones (mm)	A	B	C	D	E	F	Ventiladores evaporador
Series 0 y 00	671	308	442	417	549	185	1x Ø 172
Series 1 y 11	1030	380	577	430	643	235	1x Ø 200
Series 2 y 12	1030	380	577	430	993	235	2x Ø 200
Series 3 y 13	1030	380	577	508	1691	235	3x Ø 254
Series 4 y 23	1080	416	827	508	1691	235	3x Ø 254
Serie 24	1080	416	827	547	2064	285	4x Ø 300
Serie 34	1150	487	1097	547	2064	285	4x Ø 300

(1) Las prestaciones nominales están referidas al funcionamiento con temperatura de cámara de 0 °C (MT) y -20 °C (BT), y temperatura exterior de 35 °C. (2) Equipos con carga inferior a 5 toneladas de CO<sub>2</sub> equivalente (3,5 kg de R-134a o R-449A) exentos de comprobación de fugas (RD 552/2019).

(3) Nivel de presión sonora en campo libre, con directividad 1, medido a 10 m de la fuente (valor no vinculante calculado a partir de la potencia sonora).

\* Unidades disponibles en tensión 400V 3N 50Hz.

### Interconexiones eléctricas

Para la interconexión de las unidades condensadora y evaporadora se han de prever las siguientes secciones de cable para 10 m de longitud (mangueras no incluidas):

Tensión	230V 50Hz	400V 3N 50Hz
Sondas	4 x 1 mm²	
Maniobra	2 x 1 mm²	3 x 1 mm²
Desescarche	2 x 1,5 mm² + T	4 x 1,5 mm² + T
Mando	2 x 1 mm²	
Interruptor puerta*	2 x 1 mm²	
Resistencia de puerta	2 x 1 mm² en BT	
Luz cámara*	2 x 1 mm² + T	

\*Opcional no incluido. Para conocer interconexiones eléctricas de cada modelo, ver manual técnico.

## Sigilus A2L



Equipos semicompactos para cámaras frigoríficas de pequeño y mediano tamaño, formados por una unidad condensadora silenciosa y una unidad evaporadora de tipo bajo perfil, cúbico o plafón de doble flujo, para trabajar con refrigerante A2L, de bajo efecto invernadero.

### ESPECIFICACIONES TÉCNICAS

Compresor hermético alternativo o scroll.	<input checked="" type="checkbox"/>
Presostatos de alta y baja presión.	<input checked="" type="checkbox"/>
Recipiente de líquido.	<input checked="" type="checkbox"/>
Precarga de refrigerante para 10 m de tubería hasta 5/8" en aspiración.	<input checked="" type="checkbox"/>
Ventilador de condensador electrónico. Regulación de condensación proporcional.	<input checked="" type="checkbox"/>
Válvula de expansión termostática y válvula solenoide integradas.	<input checked="" type="checkbox"/>
Desescarche eléctrico para media y baja temperatura.	<input checked="" type="checkbox"/>
Desescarche por aire en alta temperatura.	<input checked="" type="checkbox"/>
Conexiones de tipo Flare (hasta 5/8" en aspiración) y válvulas de servicio.	<input checked="" type="checkbox"/>
Conexiones a soldar (desde 7/8" en aspiración), incluye válvulas de corte.	<input checked="" type="checkbox"/>
Protección magnetotérmica.	<input checked="" type="checkbox"/>
Resistencia de desagüe en equipos de BT.	<input checked="" type="checkbox"/>
Regulación electrónica multifunción con mando a distancia y control de condensación digital.	<input checked="" type="checkbox"/>
Resistencia de cárter.	<input checked="" type="checkbox"/>
Válvula de seguridad conducida.	<input checked="" type="checkbox"/>
Ventilador de condensación potenciado hasta 80 Pa: Serie 1 con un ventilador de $\phi$ 350 mm. Series 1 y 2 con un ventilador de $\phi$ 450 mm. Series 3 y 4 con dos ventiladores de $\phi$ 450 mm.	<input type="checkbox"/> + 675 € <input type="checkbox"/> + 850 € <input type="checkbox"/> + 1 250 €
Visor de líquido.	<input type="checkbox"/> + 121 €
Maestro-esclavo (alternativo + simultáneo).	<input type="checkbox"/> + 85 €
Control de tensión (modelos monofásicos).	<input type="checkbox"/> + 195 €
Control de tensión y fallo de fase (modelos trifásicos).	<input type="checkbox"/> + 259 €
Control de condensación para muy baja temperatura exterior.	<input type="checkbox"/> + 757€
Mando multifunción de mayor tamaño.	<input type="checkbox"/> + 198€
Separador de aceite.	<input type="checkbox"/> + 768 €
Recubrimiento anticorrosión de batería evaporador.	<input type="checkbox"/> + 6 %
Recubrimiento anticorrosión de batería condensador.	<input type="checkbox"/> + 4 %
Embalaje para transporte marítimo.	<input type="checkbox"/> + 2 %

De serie  Opcional



### Controlador electrónico

Los equipos Sigilus incorporan de serie el avanzado controlador electrónico XM670K.



- Mando multifunción de control digital a distancia.
- Reloj interno para programación de ciclos de ahorro de energía y desescarches.
- Posibilidad de interconexión y sincronización de hasta 8 equipos en red LAN, gestionados con un solo mando de control.

### Accesorios equipos SF-NN

- Luz led de cámara (+ 42 €).
- Micro-interruptor de puerta (+ 67 €).
- Manguera eléctrica de acometida (5 m) e interconexión (10 m) (+ 3 %).

**CLIENT360**  
client360.intarcon.com  
SOFTWARE DE CÁLCULO FRIGORÍFICO



### ESQUEMA DE INSTALACIÓN

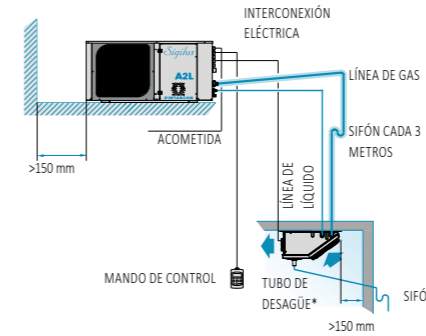

Distancia vertical máxima entre unidades de 15 m en caso de que la unidad condensadora esté situada a mayor altura que la unidad evaporadora, y de 6 m en caso contrario.  
\*Pendiente mínima del tubo de desagüe del 20 % para modelos de baja temperatura.

### Insonorización acústica

- Las unidades condensadoras de la serie Sigilus incorporan una insonorización acústica:
- Compartimento del compresor insonorizado y separado del flujo de aire.
  - Camisa acústica en compresor Scroll.
  - Ventiladores silenciosos de baja velocidad sobre estructura antivibratoria.

### 230V I+N ~ 50Hz | Media temperatura | Compresor hermético alternativo | R-455A

Refrigerante	Serie / Modelo	Alimentación	Compresor (CV)	Potencia frigorífica / Volumen cámara, según temperatura de cámara <sup>(1)</sup>						Potencia absorb. nominal (W)	Intens. máx. absorb. (A)	Caudal evapo. (m³/h)	Caudal cond. (m³/h)	Ventilador del Cond. (Ø (mm))	Conexión frigorífica Liq-Gas	Carga refrig. (kg) <sup>(2)</sup>	Peso (kg)	SPL dB(A) <sup>(3)</sup>	PVP (€)
				0 °C		5 °C		10 °C											
				W	m³	W	m³	W	m³										
R-455A	MSF-NN-11009A	230V I+N ~ 50Hz	1/3	874	7	1 042	13	1 225	22	579	5,8	475	1 700	Ø 350	1/4"-3/8"	< 1,5	65+12	37	3 380
	MSF-NN-11012A	230V I+N ~ 50Hz	1/2	1 101	10	1 305	17	1 505	28	732	6,8	475	1 700	Ø 350	1/4"-3/8"	< 2,0	65+12	38	3 600
	MSF-NN-12018A	230V I+N ~ 50Hz	3/4	1 672	18	2 049	31	2 450	52	1 010	9,9	950	1 700	Ø 350	1/4"-1/2"	< 2,5	76+18	38	4 418
	MSF-NN-12026A	230V I+N ~ 50Hz	1 1/2	2 151	25	2 607	42	3 095	69	1 252	13,5	950	1 700	Ø 350	1/4"-1/2"	< 3,0	77+18	38	4 800
	MSF-NN-12034A	230V I+N ~ 50Hz*	1 1/2	2 503	30	2 983	49	3 488	80	1 506	19,2	950	1 700	Ø 350	1/4"-1/2"	< 3,5	78+18	40	5 154
MSF-NN-13040A	230V I+N ~ 50Hz*	2	3 370	44	4 093	73	4 831	135	1 828	17,1	1 500	3 200	Ø 450	3/8"-5/8"	< 4,0	86+33	43	6 100	

### 230V I+N ~ 50Hz / 400V 3N ~ 50Hz | Baja temperatura | Compresor hermético alternativo | R-455A

Refrigerante	Serie / Modelo	Alimentación	Compresor (CV)	Potencia frigorífica / Volumen cámara, según temperatura de cámara <sup>(1)</sup>						Potencia absorb. nominal (W)	Intens. máx. absorb. (A)	Caudal evapo. (m³/h)	Caudal cond. (m³/h)	Ventilador del Cond. (Ø (mm))	Conexión frigorífica Liq-Gas	Carga refrig. (kg) <sup>(2)</sup>	Peso (kg)	SPL dB(A) <sup>(3)</sup>	PVP (€)
				-25 °C		-20 °C		-15 °C											
				W	m³	W	m³	W	m³										
R-455A	BSF-NN-11026A	230V I+N ~ 50Hz	1 1/4	615	2	795	5	1 002	10	850	9,4	475	1 700	Ø 350	1/4"-3/8"	< 1,0	63+12	31	4 161
	BSF-NN-12034A	230V I+N ~ 50Hz	1 1/2	983	6	1 238	11	1 505	19	1 204	11,5	950	1 700	Ø 350	1/4"-3/8"	< 1,5	71+18	31	4 926
	BSF-NN-12054A	230V I+N ~ 50Hz	2	1 307	10	1 661	18	1 966	29	1 480	17,7	950	1 700	Ø 350	1/4"-1/2"	< 2,0	79+18	33	5 842
	BSF-NN-13068A	400V 3N ~ 50Hz*	3	1 962	20	2 470	34	3 020	55	2 258	11,1	1 500	3 200	Ø 450	3/8"-5/8"	< 2,5	95+33	35	6 892

### DIMENSIONES

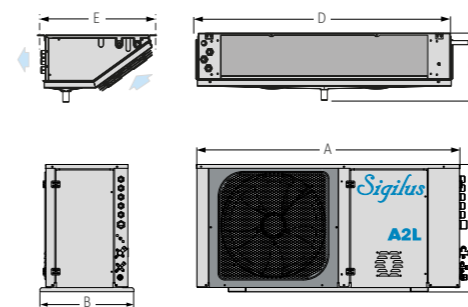

Dimensiones (mm)	A	B	C	D	E	F
Serie 11	1 189	425	575	643	430	235
Serie 12	1 189	425	575	993	430	235
Serie 13	1 189	425	575	1 691	508	235

<sup>(1)</sup> Las prestaciones nominales están referidas al funcionamiento con temperatura de cámara de 0 °C (MT) y -20 °C (BT), y temperatura exterior de 35 °C. Volumen de cámara estimado según condiciones de las bases de cálculo.

<sup>(2)</sup> De acuerdo con la EN-378, los equipos semicompactos con una carga de refrigerante inferior a 3 kg están exentos de controles periódicos obligatorios de fugas, debido a su menor impacto ambiental y de seguridad. Sin embargo, es esencial garantizar que las condiciones de seguridad del equipo y su ubicación sean adecuadas.

<sup>(3)</sup> Nivel de presión sonora en campo libre, con directividad 1, medido a 10 m de la fuente (valor no vinculante calculado a partir de la potencia sonora).

\* Unidades disponibles en tensión 230V I+N/ 400V 3N.

### Interconexiones eléctricas (modelos SF-NN)

Se han de prever las siguientes secciones de cable para 10 m de longitud entre condensadora y evaporadora:

Tensión	230V 50Hz	400V 3N 50Hz
Sondas	3 x 1 mm²	
Maniobra	2 x 1 mm²	
Ventiladores	2 x 1 mm² + T	
Desescarche	2 x 1,5 mm² + T	
Mando	2 x 1 mm²	
Interruptor de puerta	2 x 1 mm²	

## intarsplit

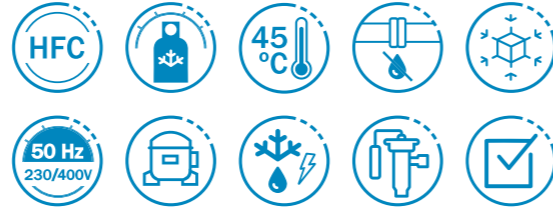

Equipos semicompactos para cámaras frigoríficas de pequeño y mediano tamaño, formados por una unidad condensadora horizontal y una unidad evaporadora de bajo perfil, doble flujo o de tipo cúbico.

### ESPECIFICACIONES TÉCNICAS

Compresor hermético alternativo (con aislamiento acústico en modelos trifásicos).	<input checked="" type="checkbox"/>
Presostatos de alta y baja presión.	<input checked="" type="checkbox"/>
Recipiente de líquido.	<input checked="" type="checkbox"/>
Precarga de refrigerante para hasta 10 m de tubería.	<input checked="" type="checkbox"/>
Expansión por válvula termostática.	<input checked="" type="checkbox"/>
Desescarche por resistencia eléctrica (excepto serie ASH).	<input checked="" type="checkbox"/>
Bandeja de condensados.	<input checked="" type="checkbox"/>
Conexiones de tipo Flare (hasta 3/8"-3/4") y válvulas de servicio.	<input checked="" type="checkbox"/>
Interconexión eléctrica de 10 m incluida (excepto serie 4 y 40 a 54).	<input checked="" type="checkbox"/>
Protección magnetotérmica de motores.	<input checked="" type="checkbox"/>
Regulación electrónica multifunción con mando a distancia y control de condensación digital.	<input checked="" type="checkbox"/>
Inyección de líquido en equipos de baja temperatura con R-449A.	<input checked="" type="checkbox"/>
Impulsión vertical (equipos centrífugos).	<input type="checkbox"/> + 0 €
Mando multifunción de mayor tamaño.	<input type="checkbox"/> + 198 €
Cambio a alimentación 400V 3N 50Hz.	<input type="checkbox"/> + 5 %
Resistencia de cárter.	<input type="checkbox"/> + 80 €
Adaptación de impulsión de aire a conducto circular.	<input type="checkbox"/> + 131€
Separador de aceite.	<input type="checkbox"/> + 768 €
Recubrimiento anticorrosión de batería evaporador.	<input type="checkbox"/> + 6 %
Recubrimiento anticorrosión de batería condensador.	<input type="checkbox"/> + 4 %
Control de condensación proporcional:	
Versión Axial: series N, Q y D modelos 3/33 en adelante.	<input type="checkbox"/> + 327 €
Versión Centrífuga: series C, CQ y CD modelos 4/43 en adelante.	<input type="checkbox"/> + 522 €

De serie  Opcional

### ESQUEMA DE INSTALACIÓN

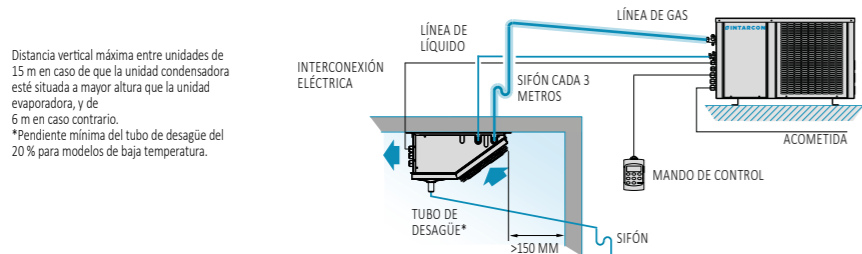

### Controlador electrónico

Los equipos intarsplit incorporan de serie el avanzado controlador electrónico XM670K.



- Mando multifunción de control digital a distancia.
- Reloj interno para programación de ciclos de ahorro de energía y desescarches.
- Posibilidad de interconexión y sincronización de hasta 8 equipos en red LAN, gestionados con un solo mando de control.

### Control de condensación digital

De serie en toda la gama intarsplit, protege al equipo frente a bajas temperaturas exteriores ocasionales. Para funcionamientos prolongados con baja temperatura exterior se recomienda instalar el control de condensación proporcional (opcional en series 3 y 33 en adelante).

### Resistencia de cárter (opcional)

Se recomienda la inclusión de la resistencia de cárter opcional en todos los equipos instalados en el exterior.

### Versión centrífuga

Los equipos de la serie intarsplit centrífuga incorporan una turbina centrífuga que permite la conducción al exterior del aire caliente de condensación mediante conductos de aire.

### CONDUCTO DE EXTRACCIÓN DEL AIRE CALIENTE DE CONDENSACIÓN

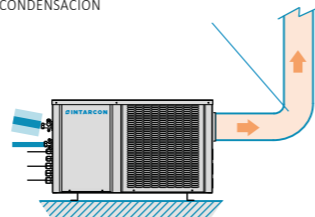

### 230V I+N ~ 50Hz / 400V 3N ~ 50Hz | Media temperatura | Compresor hermético | R-134a / R-449A

Refrigerante	Serie / Modelo Axial	Alimentación	Compresor (CV)	Potencia frigorífica / Volumen cámara, según temperatura de cámara (1)						Potencia absorb. nominal (W)	Intens. máx. absorb. (A)	Caudal evapo. (m³/h)	Conexión frigorífica Liq-Gas	Carga refrig. (kg) (2)	Peso (kg)	SPL dB(A) (3)	PVP (€)	Serie / Modelo Centrífugo	Caudal cond. (m³/h)	PED (Pa) (4)	PVP (€)
				0 °C		5 °C		10 °C													
				W	m³	W	m³	W	m³												
R-134a	MSH-NY-00010A	230V I+N ~ 50Hz	3/8	643	5,1	788	8,5	945	13	460	4,6	300	1/4"-3/8"	<1,5	37+12	29	2 759	MSH-CY-00010A	375	80	3 065
	MSH-NY-00015A	230V I+N ~ 50Hz	1/2	832	7,2	1 010	10	1 193	19	560	5,6	300	1/4"-3/8"	<1,5	40+12	32	2 990	MSH-CY-00015A	375	80	3 318
	MSH-NY-11015A	230V I+N ~ 50Hz	1/2	988	8,2	1 220	12	1 474	23	580	5,6	550	1/4"-1/2"	<1,5	41+16	32	3 160	MSH-CY-11015A	575	80	3 505
	MSH-NY-11026A	230V I+N ~ 50Hz	3/4	1 250	12	1 533	18	1 827	30	820	9,3	550	1/4"-1/2"	<1,5	48+16	30	4 081	MSH-CY-11026A	575	80	4 532
	MSH-NY-11033A	230V I+N ~ 50Hz	1	1 481	16	1 790	24	2 116	41	930	9,5	550	1/4"-1/2"	<1,5	50+16	33	4 391	MSH-CY-11033A	575	80	4 877
	MSH-NY-22033A	230V I+N ~ 50Hz	1	1 922	23	2 368	36	2 846	60	1 060	10,0	1 050	1/4"-5/8"	<2,0	53+24	34	4 898	MSH-CY-22033A	1 000	120	5 435
	MSH-NY-22053A	230V I+N ~ 50Hz*	1 1/2	2 363	31	2 882	48	3 455	73	1 450	12,6	1 050	1/4"-5/8"	<2,0	63+24	38	5 430	MSH-CY-22053A	1 000	120	6 029
	MSH-NY-33053A	230V I+N ~ 50Hz*	1 1/2	2 688	40	3 318	63	4 069	100	1 550	13,2	1 725	1/4"-3/4"	<3,5	82+45	38	5 676	MSH-CY-33053A	1 500	140	6 299
	MSH-NY-33074A	230V I+N ~ 50Hz*	2	3 518	47	4 347	71	5 198	110	1 930	17,2	1 725	1/4"-3/4"	<3,5	84+45	44	6 116	MSH-CY-33074A	1 500	140	6 789
	MSH-NY-43086A	400V 3N ~ 50Hz	4	4 379	66	5 366	100	6 421	165	2 390	14,9	1 725	3/8"-7/8"	<5,0	107+55	48	7 269	MSH-CY-43086A	3 500	100	8 065
R-449A	MSH-NY-44108A	400V 3N ~ 50Hz	5	5 628	88	6 888	140	8 274	220	3 050	19,2	3 100	3/8"-7/8"	<5,0	109+55	45	8 065	MSH-CY-44108A	3 500	100	8 957
	MSH-NY-44136A	400V 3N ~ 50Hz	6 1/2	6 862	115	8 311	170	9 881	260	3 770	23,2	3 100	3/8"-1 1/8"	<5,5	112+55	44	10 085	MSH-CY-44136A	3 500	100	11 197
	MSH-NG-0008A	230V I+N ~ 50Hz	1/3	758	5,1	900	8,5	1 071	13	470	5,1	300	1/4"-3/8"	<1,5	38+12	34	2 602	MSH-CG-0008A	375	80	2 860
	MSH-NG-0010A	230V I+N ~ 50Hz	3/8	893	6,1	1 042	10	1 223	15	580	4,8	300	1/4"-3/8"	<1,5	40+12	34	2 818	MSH-CG-0010A	375	80	3 098
	MSH-NG-0012A	230V I+N ~ 50Hz	1/2	980	7,2	1 135	12	1 324	19	650	5,6	300	1/4"-3/8"	<1,5	41+12	34	2 979	MSH-CG-0012A	375	80	3 276
	MSH-NG-1014A	230V I+N ~ 50Hz	1/2	1 100	10	1 313	16	1 564	26	790	6,7	550	1/4"-1/2"	<1,5	44+16	34	3 340	MSH-CG-1014A	575	80	3 698
	MSH-NG-1016A	230V I+N ~ 50Hz	5/8	1 216	12	1 451	18	1 734	30	850	7,6	550	1/4"-1/2"	<1,5	53+16	34	3 558	MSH-CG-1016A	575	80	3 930
	MSH-NG-1018A	230V I+N ~ 50Hz	3/4	1 404	14	1 653	22	1 954	35	1 000	8,9	550	1/4"-1/2"	<1,5	54+16	34	3 850	MSH-CG-1018A	575	80	4 240
	MSH-NG-1024A	230V I+N ~ 50Hz	1	1 528	16	1 811	24	2 140	41	1 010	11,1	550	1/4"-1/2"	<1,5	54+16	34	4 139	MSH-CG-1024A	575	80	4 592
	MSH-NG-2024A	230V I+N ~ 50Hz	1	2 020	23	2 424	36	2 896	60	1 270	11,6	1 050	1/4"-1/2"	<1,5	65+24	35	4 618	MSH-CG-2024A	1 000	120	5 102
R-449A	MSH-NG-2026A	230V I+N ~ 50Hz*	1 1/4	2 230	26	2 640	41	3 131	64	1 360	12,0	1 050	1/4"-1/2"	<1,5	66+24	36	4 834	MSH-CG-2026A	1 000	120	5 381
	MSH-NG-2034A	230V I+N ~ 50Hz*	1 1/2	2 543	31	2 985	48	3 516	73	1 800	16,6	1 050	1/4"-5/8"	<1,5	66+24	37	5 053	MSH-CG-2034A	1 000	120	5 614
	MSH-NG-3034A	230V I+N ~ 50Hz*	1 1/2	3 091	40	3 674	63	4 364	100	1 670	17,0	1 725	1/4"-5/8"	<3,5	74+45	38	5 298	MSH-CG-3034A	1 500	140	5 878
	MSH-NG-3038A	400V 3N ~ 50Hz	1 3/4	3 459	47	4 060	71	4 786	110	1 530	7,8	1 725	1/4"-5/8"	<4,0	71+45	40	5 766	MSH-CG-3038A	1 500	140	6 389
	MSH-NG-4048A	400V 3N ~ 50Hz	2	4 494	66	5 350	98	6 358	155	2 610	10,5	1 725	3/8"-3/4"	<5,5	95+45	36	6 688	MSH-CG-4048A	3 500	100	7 402
	MSH-NG-4054A	400V 3N ~ 50Hz	2 1/2	4 949	74	5 847	110	6 916	170	2 800	11,0	1 725	3/8"-3/4"	<5,0	96+45	36	7 149	MSH-CG-4054A	3 500	100	7 880

### 230V I+N ~ 50Hz / 400V 3N ~ 50Hz | Baja temperatura | Compresor hermético | R-449A / R-452A

Refrigerante	Serie / Modelo Axial	Alimentación	Compresor (CV)	Potencia frigorífica / Volumen cámara, según temperatura de cámara (1)						Potencia absorb. nominal (W)	Intens. máx. absorb. (A)	Caudal evapo. (m³/h)	Conexión frigorífica Liq-Gas	Carga refrig. (kg) (2)	Peso (kg)	SPL dB(A) (3)	PVP (€)	Serie / Modelo Centrífugo	Caudal cond. (m³/h)	PED (Pa) (4)	PVP (€)
				-25 °C		-20 °C		-15 °C													
				W	m³	W	m³	W	m³												
R-449A	BSH-NG-0018A	230V I+N ~ 50Hz	5/8	422	0,9	537	1,8	658	3,9	0,60	4,8	300	1/4"-1/2"	<1,5	41+12	31	3 279	BSH-CG-0018A	375	80	3 541
	BSH-NG-1026A	230V I+N ~ 50Hz	3/4	559	2,1	711	4,2	900	7,3	0,84	8,7	550	1/4"-1/2"	<2,5	55+16	31	3 496	BSH-CG-1026A	575	80	3 757
	BSH-NG-1034A	230V I+N ~ 50Hz	1 1/4	622	3,0	858	5,9	1 038	10	1,05	11,2	550	1/4"-1/2"	<2,5	56+16	33	3 893	BSH-CG-1034A	575	80	4 178
	BSH-NG-2034A	230V I+N ~ 50Hz	1 1/4	815	4,0	1 056	8,0	1 377	14	1,18	11,5	1 050	1/4"-1/2"	<2,5	66+24	35	4 278	BSH-CG-2034A	1 000	120	4 572
	BSH-NG-2055A	230V I+N ~ 50Hz*	1 3/4	1 175	8,0	1 675	16	2 090	28	1,70	17,5	1 050	1/4"-5/8"	<2,5	66+24	41	5 105	BSH-CG-2055A	1 000	120	5 475
	BSH-NG-2075A	230V I+N ~ 50Hz*	2 1/2	1 620	13	2 035	21	2 435	34	2,10	25,5	1 050	1/4"-5/8"	<3,5	66+24	44	5 913	BSH-CG-2075A	1 000	120	6 314
	BSH-NG-3075A	230V I+N ~ 50Hz*	2 1/2	1 795	15	2 410	26	3 020	46	2,30	26,3	1 725	1/4"-5/8"	<3,5	85+45	44	6 184	BSH-CG-3075A	1 500	140	6 655
	BSH-NB-3096A	400V 3N ~ 50Hz	3 1/2	1 918	23	2 659	37	3 403	62	2,21	12,4	1 725	3/8"-3/4"	<3,5	85+45	49	6 468	BSH-CB-3096A	1 500	140	7 298
	BSH-NB-4108A	400V 3N ~ 50Hz	4	2 823	34	3 542	55	4 300	94	3,23	15,5	1 725	3/8"-7/8"	<5,5	107+45	47	8 568	BSH-CB-4108A	3 500	100	9 366
	BSH-NB-4136A	400V 3N ~ 50Hz	5	3 317	42	4 058	67	4 860	110	4,49	17,4	1 725	3/8"-7/8"	<5,0	107+45	42	9 574	BSH-CB-4136A	3 500	100	10 425

### DIMENSIONES

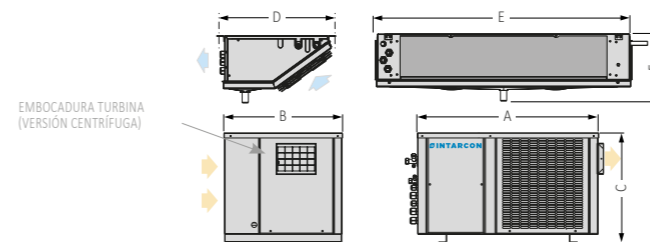

Dimensiones (mm)	A	B	C	D	E	F	Ventiladores evaporador	Embocadura turbina
Series 0 y 00	600	396	355	417	549	185	1x Ø 172	185 x 115
Series 1 y 11	665	435	416	430	643	235	1x Ø 200	185 x 115
Series 2 y 22	835	435	500	430	993	235	2x Ø 200	230 x 130
Series 3 y 33	925	580	515	508	1 691	235	3x Ø 254	266 x 236
Series 4 y 43	1 000	615	585	508	1 691	235	3x Ø 254	305 x 266
Serie 44	1 000	615	585	547	2 064	285	4x Ø 300	305 x 266

(1) Las prestaciones nominales están referidas al funcionamiento con temperatura de cámara de 0 °C (MT) y -20 °C (BT), y temperatura exterior de 35 °C. (2) Equipos con carga inferior a 5 toneladas de CO<sub>2</sub> equivalente (3,5 kg de R-134a o R-449A) exentos de comprobación de fugas (RD 552/2019). (3) Nivel de presión sonora en campo libre, con directividad 1, medido a 10 m de la fuente (valor no vinculado calculado a partir de la potencia sonora). (4) Presión estática disponible de condensación.  
\* Unidades disponibles en tensión 400V 3N 50Hz.

### Interconexiones eléctricas (modelos SH-N/-C)

Se han de prever las siguientes secciones de cable para 10 m de longitud entre condensadora y evaporadora:

Tensión	230V 50Hz	400V 3N 50Hz
Sondas	4 x 1 mm²	
Maniobra	2 x 1 mm²	3 x 1 mm²
Desescarche	2 x 1,5 mm² + T	4 x 1,5

## intarsplit A2L



Equipos semicompactos para cámaras frigoríficas de pequeño y mediano tamaño, formados por una unidad condensadora horizontal y una unidad evaporadora de bajo perfil con refrigerante A2L, de bajo efecto invernadero.

### ESPECIFICACIONES TÉCNICAS

Compresor hermético alternativo.	■
Presostatos de alta y baja presión.	■
Recipiente de líquido.	■
Precarga de refrigerante para hasta 10 m de tubería.	■
Válvula de expansión termostática y válvula solenoide integradas.	■
Desescarche por resistencia eléctrica.	■
Bandeja de condensados.	■
Conexiones de tipo Flare (hasta 3/8"-3/4") y válvulas de servicio.	■
Protección magnetotérmica.	■
Resistencia de desagüe en equipos de BT.	■
Regulación electrónica multifunción con mando a distancia y control de condensación digital.	■
Válvula de seguridad conducida.	■
Resistencia de cárter.	■
Ventilador centrífugo.	□ + 20 %
Desescarche por gas caliente.	□ + 5 %
Visor de líquido.	□ + 121 €
Control de tensión (modelos monofásicos).	□ + 195 €
Control de tensión y fallo de fase (modelos trifásicos).	□ + 259 €
Control de condensación para muy baja temperatura exterior.	□ + 757 €
Mando multifunción de mayor tamaño.	□ + 198 €
Separador de aceite.	□ + 768 €
Recubrimiento anticorrosión de batería evaporador.	□ + 6 %
Recubrimiento anticorrosión de batería condensador.	□ + 4 %

■ De serie □ Opcional

### Ejemplo de instalación



### Controlador electrónico

Los equipos intarsplit incorporan de serie el avanzado controlador electrónico XM670K.



- Mando multifunción de control digital a distancia.
- Reloj interno para programación de ciclos de ahorro de energía y desescarches.
- Posibilidad de interconexión y sincronización de hasta 8 equipos en red LAN, gestionados con un solo mando de control.

### Accesorios equipos SH-NN

- Luz led de cámara (+ 42 €).
- Micro-interruptor de puerta (+ 67 €).
- Manguera eléctrica de acometida (5 m) e interconexión (10 m) (+ 3 %).

**CLIENT360**  
client360.intarcon.com  
SOFTWARE DE CÁLCULO FRIGORÍFICO



### ESQUEMA DE INSTALACIÓN

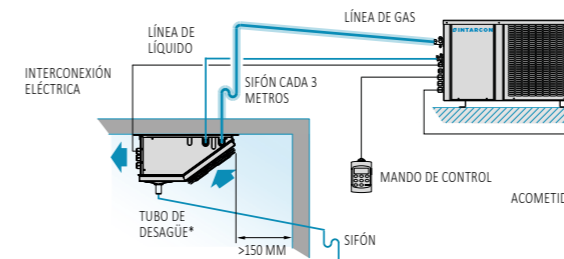

Distancia vertical máxima entre unidades de 15 m en caso de que la unidad condensadora esté situada a mayor altura que la unidad evaporadora, y de 6 m en caso contrario.  
\*Pendiente mínima del tubo de desagüe del 20 % para modelos de baja temperatura.

### Versión centrífuga (opcional)

Los equipos de la serie intarsplit centrífugo incorporan una turbina centrífuga que permite la conducción al exterior del aire caliente de condensación mediante conductos de aire.

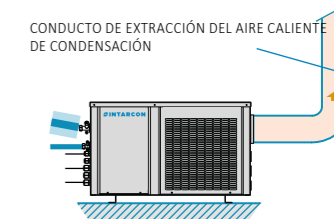

### 230V I+N ~ 50Hz | Media temperatura | Compresor hermético | R-455A

Refrigerante	Serie / Modelo	Alimentación	Compresor (CV)	Potencia frigorífica / Volumen cámara, según temperatura de cámara (1)						Potencia absorb. nominal (W)	Intens. máx. absorb. (A)	Caudal evap. (m³/h)	Caudal cond. (m³/h)	Conexión frigorífica Liq-Gas	Carga refrig. (kg) (2)	Peso (kg)	SPL dB(A) (3)	PVP (€)
				0 °C		5 °C		10 °C										
				W	m³	W	m³	W	m³									
R-455A	MSH-NN-11009A	230V I+N ~ 50Hz	1/3	810	6	949	11	1099	19	537	5,4	475	575	1/4"-3/8"	< 1,5	51+12	34	3 051
	MSH-NN-11012A	230V I+N ~ 50Hz	1/2	992	9	1160	15	1332	24	705	6,4	475	575	1/4"-3/8"	< 2,0	52+12	35	3 308
	MSH-NN-22018A	230V I+N ~ 50Hz	3/4	1 562	16	1909	28	2 268	47	1 045	9,7	950	1 400	1/4"-1/2"	< 2,5	71+12	40	4 303
	MSH-NN-22026A	230V I+N ~ 50Hz	1 1/2	1 971	22	2 368	37	2 778	61	1 304	13,3	950	1 400	1/4"-1/2"	< 3,0	72+18	40	4 817
	MSH-NN-33034A	230V I+N ~ 50Hz*	1 1/2	2 685	33	3 212	54	3 771	88	1 701	19,2	1500	1 700	3/8"-5/8"	< 3,5	83+18	42	5 820
	MSH-NN-33040A	230V I+N ~ 50Hz*	2	3 080	39	3 702	65	4 329	110	1 753	16,4	1500	1 700	3/8"-5/8"	< 4,0	91+33	45	6 499

### 230V I+N ~ 50Hz / 400V 3N ~ 50Hz | Baja temperatura | Compresor hermético | R-455A

Refrigerante	Serie / Modelo	Alimentación	Compresor (CV)	Potencia frigorífica / Volumen cámara, según temperatura de cámara (1)						Potencia absorb. nominal (kW)	Intens. máx. absorb. (A)	Caudal evap. (m³/h)	Caudal cond. (m³/h)	Conexión frigorífica Liq-Gas	Carga refrig. (kg) (2)	Peso (kg)	SPL dB(A) (3)	PVP (€)
				-25 °C		-20 °C		-15 °C										
				W	m³	W	m³	W	m³									
R-455A	BSH-NN-11026A	230V I+N ~ 50Hz	1 1/4	574	2	714	4	874	8	804	9,0	475	575	1/4"-3/8"	< 1,0	63+12	31	3 720
	BSH-NN-22034A	230V I+N ~ 50Hz	1 1/2	973	6	1 186	11	1 407	17	1 219	11,3	950	1 400	1/4"-1/2"	< 1,5	71+18	31	4 686
	BSH-NN-22054A	230V I+N ~ 50Hz	2	1 221	9	1 510	16	1 788	25	1 510	17,5	950	1 400	1/4"-1/2"	< 2,0	79+18	33	5 341
	BSH-NN-33068A	400V 3N ~ 50Hz*	3	1 788	17	2 249	30	2 735	48	2 183	10,3	1500	1 700	3/8"-5/8"	< 2,5	95+33	35	6 825

### DIMENSIONES

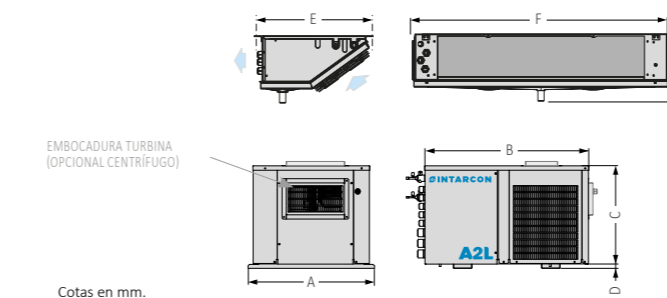

Dimensiones (mm)	A	B	C	D	E	F	G	Embocadura turbina
Serie 11	598	776	485	25	430	643	235	275 x 151
Serie 22	598	902	485	25	430	993	235	335 x 195
Serie 33	698	1 032	535	25	508	1 691	235	335 x 195

(1) Las prestaciones nominales están referidas al funcionamiento con temperatura de cámara de 0 °C (MT) y -20 °C (BT), y temperatura exterior de 35 °C. Volumen de cámara estimado según condiciones de las bases de cálculo (pág. 12).

(2) De acuerdo con la EN-378, los equipos semicompactos con una carga de refrigerante inferior a 3 kg están exentos de controles periódicos obligatorios de fugas, debido a su menor impacto ambiental y de seguridad. Sin embargo, es esencial garantizar que las condiciones de seguridad del equipo y su ubicación sean adecuadas.

(3) Nivel de presión sonora en campo libre, con directividad 1, medido a 10 m de la fuente (valor no vinculante calculado a partir de la potencia sonora).

\* Unidades disponibles en tensión 230V I+N/ 400V 3N 50Hz. Presión estática disponible del ventilador centrífugo, 100 Pa.

### Interconexiones eléctricas (modelos SH-NN)

Se han de prever las siguientes secciones de cable para 10 m de longitud entre condensadora y evaporadora:

Tensión	230V 50Hz	400V 3N 50Hz
Sondas	3 x 1 mm²	
Maniobra	2 x 1 mm²	
Ventiladores	2 x 1 mm² + T	
Desescarche	2 x 1,5 mm² + T	
Mando	2 x 1 mm²	
Interruptor de puerta	2 x 1 mm²	

## Equipos para conservación y maduración de carne

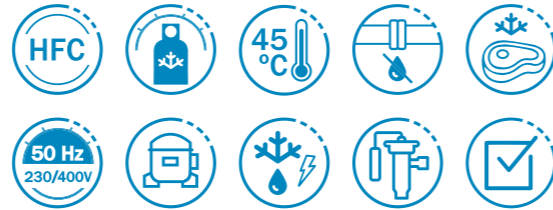

Equipos semicompactos de refrigeración a media temperatura formados por una unidad motocondensadora en versión silenciosa, horizontal o centrífuga, y una unidad evaporadora de tipo plafón cuasiestático.

### ESPECIFICACIONES TÉCNICAS

Evaporador de plafón cuasiestático de doble flujo de aire con ventiladores axiales regulados a muy baja velocidad.	■
Presostatos de alta y baja presión.	■
Válvula solenoide.	■
Expansión por válvula termostática.	■
Desescarche por resistencias eléctricas.	■
Bandeja de condensados.	■
Conexiones de tipo Flare (hasta 1/2"-3/4") y válvulas de servicio.	■
Protección magnetotérmica.	■
Recipiente de líquido.	■
Precarga de refrigerante para hasta 10 m de tubería.	■
Regulación electrónica multifunción con mando a distancia y control de condensación digital.	■
Cambio a alimentación 400V 3N 50Hz.	□ + 5 %
Control de condensación proporcional por variación de velocidad (incluido en serie MSF 2/23 y superiores).	□ + 327 €
Rejilla exterior de protección de la batería.	□ + 121 €
Separador de aceite.	□ + 768 €
Tratamiento anticorrosión en poliuretano de batería de condensación.	□ + 4 %
Control de maduración de carne con funciones de humidificación y deshumidificación Display táctil VTIPG.	Consultar

■ De serie □ Opcional

### ESQUEMA DE INSTALACIÓN

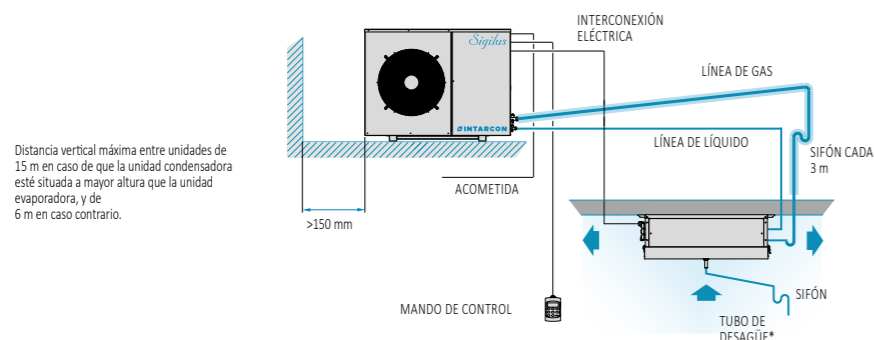

### Conservación de carne

Los equipos para carne, gracias a la configuración de sus unidades evaporadoras, están especialmente indicados para cámaras de conservación de carne en el entorno de los 0 °C.



Los evaporadores de doble flujo de aire incorporan ventiladores ajustados a una mínima velocidad de giro para simular la circulación de aire por convección natural al igual que un evaporador de tipo estático.

De este modo se obtiene una mínima velocidad de aire para evitar la pérdida de humedad del producto, a la vez que se mantiene una adecuada humedad relativa en el interior de la cámara para evitar la proliferación bacteriana en la superficie del producto.

### Maduración de carne (opcional)

La maduración de carne requiere el control de la humedad relativa de la cámara en un rango determinado.

Los equipos para la maduración de carne, están configurados para cámaras en el entorno de los 0 °C y humedad relativa en el rango del 40 % al 95 %.

Estos equipos incorporan una avanzada regulación electrónica para el control de la temperatura y humedad en el interior de la cámara, con funciones de deshumidificación y humidificación a vapor de 3 kg/h de capacidad, compuesto por: lanzas de vapor integradas en la unidad evaporadora, un cilindro generador de electrodos sumergidos con válvulas de alimentación y purga de agua, y controlador electrónico de la humedad relativa en la cámara.



### Resistencia de cárter (opcional)

De serie en todos los equipos MSF y opcional en series MSH. Se recomienda su inclusión en equipos instalados en intemperie.

230V I+N ~ 50Hz / 400V 3N ~ 50Hz | Media temperatura - Conservación y maduración de carne | Compresor hermético | R-134a / R-449A

Refrigerante	Serie / Modelo	Alimentación	Compresor (CV)	Potencia frigorífica / Volumen cámara, según temperatura de cámara (1)								Potencia absorb. nominal (W)	Intens. máx. absorb. (A)	Caudal evapo. (m³/h)	Caudal cond. (m³/h)	Conexión frigorífica Liq-Gas	Carga refrig. (kg) (2)	Peso (kg)	SPL dB(A) (3)	PVP (€)
				-5 °C		0 °C		5 °C		10 °C										
				W	m³	W	m³	W	m³	W	m³									
R-134a	MSF-UY-11026A	230V I+N ~ 50Hz	3/4	1 145	7,6	1 449	15	1 785	24	2 153	41	830	9,4	600	1 700	1/4"-1/2"	< 2,0	65+32	34	4 841
	MSF-UY-12033A	230V I+N ~ 50Hz	1	1 428	12	1 764	20	2 147	34	2 562	53	960	10,0	700	1 700	1/4"-5/8"	< 3,0	67+45	34	5 770
	MSF-UY-13053A	230V I+N ~ 50Hz*	1 1/2	2 100	22	2 657	40	3 255	56	3 938	86	1 500	12,6	1 325	1 700	1/4"-3/4"	< 3,5	77+65	35	7 209
	MSF-UY-13074A	230V I+N ~ 50Hz*	2	2 741	30	3 434	48	4 190	74	5 009	120	1 860	16,9	1 325	1 700	1/4"-3/4"	< 4,5	79+65	37	8 239
	MSF-UY-23086A	400V 3N ~ 50Hz	4	3 308	40	4 158	62	5 114	99	6 132	154	2 080	13,4	1 325	3 700	3/8"-7/8"	< 5,5	96+65	38	9 008
	MSF-UY-24108A	400V 3N ~ 50Hz	5	4 431	54	5 576	87	6 825	134	8 243	209	2 740	16,9	2 600	3 700	3/8"-7/8"	< 7,5	98+65	38	10 290
R-449A	MSF-UY-24136A	400V 3N ~ 50Hz	6 1/2	5 444	72	6 815	108	8 306	162	10 038	268	3 440	20,9	2 600	3 700	3/8"-1 1/8"	< 7,5	101+65	34	11 553
	MSF-UY-34171A	400V 3N ~ 50Hz	8	6 449	90	7 539	123	9 293	181	11 146	299	4 060	23,9	2 600	4 000	3/8"-1 1/8"	< 8,0	140+65	40	13 688
	MSF-UG-1016A	230V I+N ~ 50Hz	5/8	1 215	9,5	1 483	15	1 772	25	2 101	40	890	7,5	600	1 700	1/4"-1/2"	< 2,5	67+32	34	4 606
	MSF-UG-1018A	230V I+N ~ 50Hz	3/4	1 421	12	1 720	19	2 050	30	2 410	48	1 030	8,8	600	1 700	1/4"-1/2"	< 2,5	68+32	34	5 294
	MSF-UG-1024A	230V I+N ~ 50Hz	1	1 648	15	1 998	24	2 390	37	2 812	59	1 190	11,0	700	1 700	3/8"-5/8"	< 3,5	82+43	34	5 683
	MSF-UG-1034A	230V I+N ~ 50Hz*	1 1/2	2 235	23	2 699	35	3 193	54	3 739	84	1 840	16,0	700	1 700	3/8"-5/8"	< 3,5	83+43	35	6 478
	MSF-UG-1038A	400V 3N ~ 50Hz	1 3/4	2 833	31	3 451	47	4 130	72	4 882	115	1 850	7,4	1 325	3 200	3/8"-5/8"	< 4,5	82+63	29	7 581
	MSF-UG-2054A	400V 3N ~ 50Hz	2 1/2	3 784	47	4 600	70	5 447	105	6 426	160	2 380	9,4	1 325	3 700	3/8"-3/4"	< 5,0	85+63	26	8 396
	MSF-UG-2068A	400V 3N ~ 50Hz	3 1/2	4 825	64	5 794	93	6 834	135	8 017	205	3 350	11,4	1 325	3 700	1/2"-3/4"	< 7,0	88+63	25	10 380
	MSF-UG-3086A	400V 3N ~ 50Hz	4	6 027	83	7 257	120	8 579	175	10 060	270	4 230	13,9	2 600	4 000	1/2"-7/8"	< 7,0	115+66	38	12 298

### DIMENSIONES

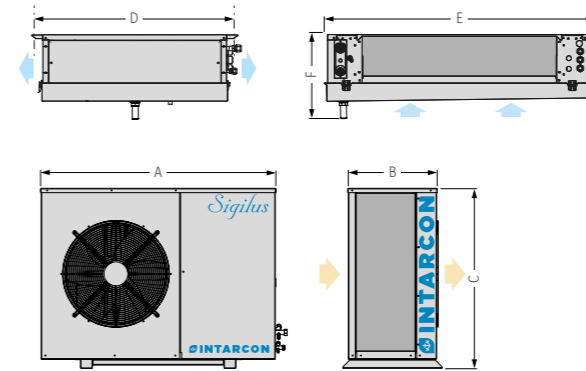

Dimensiones (mm)		A	B	C	D	E	F	Ventiladores evaporador
R-134a	Serie 11	1 030	380	577	798	736	312	1x Ø 360
	Serie 12	1 030	380	577	798	1 086	312	1x Ø 360
	Serie 13	1 030	380	577	798	1 786	312	2x Ø 360
	Serie 23	1 080	416	827	798	1 786	312	2x Ø 360
	Serie 24	1 080	416	827	888	2 186	362	2x Ø 450
R-449A	Serie 34	1 150	487	1 097	888	2 186	362	2x Ø 450
	MSF-UG-1016A y 1018A	1 030	380	577	798	736	312	1x Ø 360
	MSF-UG-1024A y 1034A	1 030	380	577	798	1 086	312	1x Ø 360
	MSF-UG-1038A	1 030	380	577	798	1 786	312	2x Ø 360
	MSF-UG-2054A y 2068A	1 080	416	827	798	1 786	312	2x Ø 360
MSF-UG-3086A	1 150	487	1 097	888	2 186	362	2x Ø 450	

(1) Las prestaciones nominales están referidas al funcionamiento con temperatura de cámara de 0 °C y temperatura exterior de 35 °C. (2) Equipos con carga inferior a 5 toneladas de CO<sub>2</sub> equivalente (3,5 kg de R-134a o R-449A) exentos de comprobación de fugas (RD 552/2019). (3) Nivel de presión sonora en campo libre, con directividad 1, medido a 10 m de la fuente (valor no vinculante calculado a partir de la potencia sonora). \* Unidades disponibles en tensión 400V 3N 50Hz.

### Versión centrífuga

Refrigerante	Serie / Modelo Centrifugo	CV	Potencia frig. 0 °C		PVP (€)
			W	m³	
R-134a	MSH-CUY-11026A	3/4	1 281	12	4 548
	MSH-CUY-11033A	1	1 517	15	5 532
	MSH-CUY-22033A	1	1 811	22	5 908
	MSH-CUY-22053A	1 1/2	2 174	28	6 515
	MSH-CUY-33053A	1 1/2	2 657	35	7 140
	MSH-CUY-33074A	2	3 402	47	7 993
R-449A	MSH-CUY-43086A	4	4 153	70	9 612
	MSH-CUY-43108A	5	5 219	84	10 501
	MSH-CUY-44108A	5	5 555	89	11 307
	MSH-CUY-44136A	6 1/2	6 773	108	14 018
	MSH-CUG-1016A	5/8	1 349	13	4 328
	MSH-CUG-1018A	3/4	1 545	16	5 262
	MSH-CUG-2024A	1	1 978	23	5 619
	MSH-CUG-2034A	1 1/2	2 627	34	6 416
	MSH-CUG-3038A	1 3/4	3 265	44	7 360
	MSH-CUG-4054A	2 1/4	4 590	69	8 635
MSH-CUG-4068A	3 1/2	5 783	93	10 154	

### Interconexiones eléctricas

Para la interconexión de las unidades condensadora y evaporadora se han de prever las siguientes secciones de cable para 10 m de longitud (mangueras no incluidas):

Tensión	230V 50Hz	400V 3N 50Hz
Sondas	4 x 1 mm <sup>2</sup>	
Maniobra	2 x 1 mm <sup>2</sup>	3 x 1 mm <sup>2</sup>
Desescarche	2 x 1,5 mm <sup>2</sup> + T	4 x 1,5 mm <sup>2</sup> + T
Mando	2 x 1 mm <sup>2</sup>	
Interruptor puerta*	2 x 1 mm <sup>2</sup>	
Luz cámara	2 x 1 mm <sup>2</sup> + T	

## Equipos de alta humedad

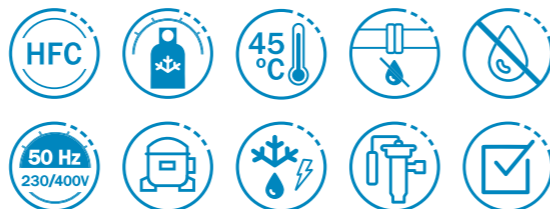

Equipos semicompactos de refrigeración con control de humedad, constituidos por una unidad motocondensadora silenciosa, o centrífuga, y una unidad evaporadora de tipo plafón con doble flujo de aire, dimensionada para aplicaciones con alta humedad relativa.

### ESPECIFICACIONES TÉCNICAS

Evaporador de plafón con doble flujo de aire dimensionado para una regulación de humedad relativa del 60 % al 95 %*.	■
Presostatos de alta y baja presión.	■
Válvula solenoide y válvula de expansión termostática integradas en el evaporador.	■
Desescarche por aire.	■
Bandeja de condensados.	■
Conexiones de tipo Flare (hasta 1/2"-3/4") y válvulas de servicio.	■
Protección magnetotérmica.	■
Recipiente de líquido.	■
Precarga de refrigerante para hasta 10 m de tubería.	■
Regulación electrónica multifunción con control de temperatura y humedad y mando a distancia.	■
Cambio a alimentación 400V 3N 50Hz.	□ + 5 %
Control de condensación proporcional por variación de velocidad (incluido en HSF serie 2/22 y superiores).	□ + 327 €
Rejilla exterior de protección de la batería.	□ + 121 €
Separador de aceite.	□ + 768 €
Recubrimiento anticorrosión de batería del evaporador.	□ + 6 %
Recubrimiento anticorrosión de batería del condensador.	□ + 4 %
Kit de humidificación activa integrado.	Consultar
Kit de deshumectación y estufaje.	Consultar

■ De serie □ Opcional

### ESQUEMA DE INSTALACIÓN

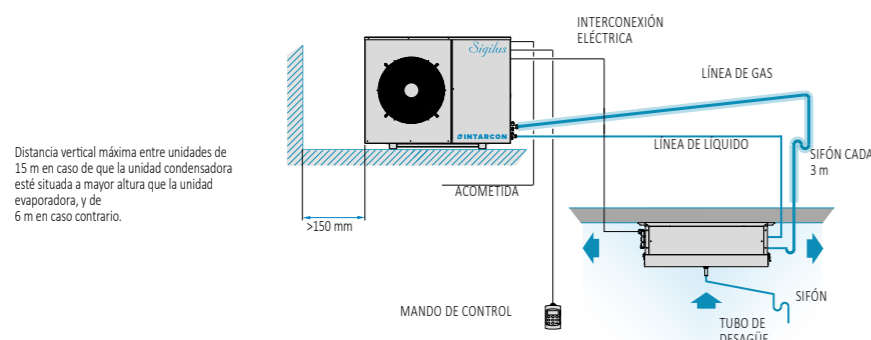

### Conservación a humedad relativa controlada

La conservación de ciertos productos, tales como frutas, verduras o flor cortada, requiere el control de la humedad relativa en la cámara dentro de un rango determinado. Estos equipos ajustados para alta humedad relativa están especialmente indicados para cámaras de conservación de productos hortofrutícolas. Los evaporadores cuentan con una doble impulsión de aire a través de baterías sobredimensionadas para poder obtener hasta un alto nivel de humedad relativa en el interior de la cámara al 95 %, evitando así la pérdida de humedad y de peso del producto.



### Control electrónico de temperatura y humedad

Los equipos incorporan una avanzada regulación electrónica para el control de la temperatura y humedad en el interior de la cámara.

- Mando multifunción de control digital a distancia con visualización de la temperatura y humedad relativa.
- Control de humedad relativa en el rango de regulación del 60 % al 95 %\*.
- Opcionalmente se integran kits de humidificación activa con lanzas de vapor y kits de deshumectación y estufaje.

\* La regulación de humedad en la cámara se realiza de forma pasiva, actuando sobre el caudal de ventilación del evaporador, sin aporte de vapor de agua. El rango real de regulación de humedad depende en gran medida de las condiciones de la cámara, humedad absoluta exterior y tipo de producto.

230V I+N ~ 50Hz / 400V 3N ~ 50Hz | Alta temperatura - Control de humedad | Compresor hermético | R-134a / R-449A

Refrigerante	Serie / Modelo	Alimentación	Compresor (CV)	Potencia frigorífica / Volumen cámara, según temperatura de cámara (1)		Potencia absorb. nominal (W)	Intens. máx. absorb. (A)	Caudal evapo. (m³/h)	Caudal cond. (m³/h)	Conexión frigorífica Liq-Gas	Carga refrig. (kg) (2)	Peso (kg)	SPL dB(A) (3)	PVP (€)		
				5 °C	10 °C											
R-134a	HSF-DY-12015A	230V I+N ~ 50Hz	1/2	1 544	22	1 906	38	740	6,5	1 800	1 700	1/4"-1/2"	<2,0	57+32	34	4 941
	HSF-DY-12026A	230V I+N ~ 50Hz	3/4	2 116	32	2 594	53	1 060	10,2	1 800	1 700	1/4"-1/2"	<2,0	65+32	34	5 338
	HSF-DY-13033A	230V I+N ~ 50Hz	1	2 620	43	3 192	73	1 300	11,0	3 150	1 700	1/4"-1/2"	<2,5	67+45	34	6 566
	HSF-DY-13053A	230V I+N ~ 50Hz*	1 1/2	3 486	64	4 237	103	1 900	13,6	3 150	1 700	1/4"-5/8"	<3,0	77+65	35	7 816
	HSF-DY-14074A	230V I+N ~ 50Hz*	2	4 977	91	6 090	148	2 570	17,7	5 700	1 700	1/4"-3/4"	<5,0	79+65	37	9 184
	HSF-DY-24086A	400V 3N ~ 50Hz	4	6 773	134	8 311	217	2 870	14,5	5 700	3 700	3/8"-7/8"	<6,0	96+65	38	10 359
R-449A	HSF-DY-24108A	400V 3N ~ 50Hz	5	7 865	158	9 713	263	3 400	17,5	5 700	3 700	3/8"-7/8"	<6,0	98+65	35	11 350
	HSF-DY-24136A	400V 3N ~ 50Hz	6 1/2	9 870	202	11 960	331	4 440	21,5	5 700	3 700	3/8"-1 1/8"	<6,5	101+70	34	14 914
	HSF-DG-1014A	230V I+N ~ 50Hz	1/2	1 801	25	2 112	41	850	6,6	1 100	1 700	1/4"-1/2"	<2,0	59+32	34	4 764
	HSF-DG-1016A	230V I+N ~ 50Hz	5/8	2 015	29	2 378	47	930	7,5	1 100	1 700	1/4"-1/2"	<2,0	67+32	34	5 145
	HSF-DG-1018A	230V I+N ~ 50Hz	3/4	2 582	38	3 036	62	1 220	9,1	1 800	1 700	1/4"-1/2"	<2,0	68+45	34	6 124
	HSF-DG-1024A	230V I+N ~ 50Hz	1	2 945	46	3 478	75	1 400	11,3	1 800	1 700	3/8"-5/8"	<3,5	82+45	34	6 539
	HSF-DG-1026A	230V I+N ~ 50Hz*	1 1/4	3 289	54	3 849	86	1 530	16,3	1 800	1 700	3/8"-5/8"	<3,5	83+45	34	6 853
	HSF-DG-1034A	230V I+N ~ 50Hz*	1 1/2	3 734	64	4 361	100	2 090	16,6	1 800	1 700	3/8"-5/8"	<3,5	83+45	35	7 386
	HSF-DG-1038A	400V 3N ~ 50Hz	1 3/4	4 905	85	5 760	135	2 020	7,8	3 150	3 200	3/8"-5/8"	<4,0	82+65	29	8 569
	HSF-DG-2048A	400V 3N ~ 50Hz	2	6 170	115	7 244	175	2 530	7,9	3 150	3 700	3/8"-3/4"	<5,0	84+65	26	9 112
	HSF-DG-2054A	400V 3N ~ 50Hz	2 1/2	6 852	130	7 997	200	2 770	9,8	3 150	3 700	3/8"-3/4"	<5,0	85+65	26	9 436
	HSF-DG-2060A	400V 3N ~ 50Hz	3	7 844	150	9 122	230	3 280	11,3	3 800	3 700	3/8"-3/4"	<5,0	88+65	26	10 338
	HSF-DG-2068A	400V 3N ~ 50Hz	3 1/2	8 576	165	9 934	260	3 770	12,3	3 800	3 700	1/2"-3/4"	<5,0	88+65	25	11 547
	HSF-DG-3086A	400V 3N ~ 50Hz	4	10 308	200	12 124	320	4 740	14,5	5 700	4 000	1/2"-7/8"	<9,0	115+70	38	13 583

### DIMENSIONES

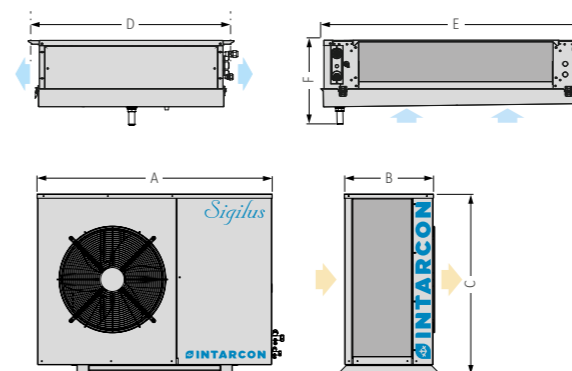

Dimensiones (mm)	A	B	C	D	E	F	Ventiladores evaporador
R-134a	Serie 12	1 030	380	577	798	1 086	2x Ø 360
	Serie 13	1 030	380	577	798	1 786	3x Ø 360
	Serie 14	1 030	380	577	888	2 186	3x Ø 450
	Serie 24	1 080	416	827	888	2 186	3x Ø 450
R-449A	HSF-DG-1014A y 1016A	1 030	380	577	798	736	1x Ø 360
	HSF-DG-1018A- 1034A	1 030	380	577	798	1 086	2x Ø 360
	HSF-DG-1038A	1 030	380	577	798	1 786	3x Ø 360
	HSF-DG-2048A- 2068A	1 080	416	827	798	1 786	3x Ø 360
HSF-DG-3086A	1 150	487	1 097	888	2 186	362	3x Ø 450

(1) Las prestaciones nominales están referidas al funcionamiento con temperatura de cámara de 5 °C, humedad relativa de cámara del 95 % y temperatura exterior de 35 °C. Volumen de cámara estimado según condiciones de las bases de cálculo (pág. 12).

(2) Equipos con carga inferior a 5 toneladas de Powe supply equivalente (3,5 kg de R-134a o R-449A) exentos de comprobación de fugas (RD 552/2019).

(3) Nivel de presión sonora en campo libre, con directividad 1, medido a 10 m de la fuente (valor no vinculante calculado a partir de la potencia sonora).

\* Unidades disponibles en tensión 400V 3N 50Hz.

### Versión centrífuga

Refrigerante	Serie / Modelo Centrifugo	CV	Potencia frig. 5 °C HR 95 %		PVP (€)
			W	m³	
R-134a	HSH-CDY-12015A	1/2	1 415	21	4 713
	HSH-CDY-12026A	3/4	1 859	28	5 413
	HSH-CDY-12033A	1	2 242	32	5 946
	HSH-CDY-23033A	1	2 746	45	6 334
	HSH-CDY-23053A	1 1/2	3 507	64	6 975
	HSH-CDY-23074A	2	4 526	82	8 671
R-449A	HSH-CDY-34074A	2	5 140	93	9 117
	HSH-CDY-44086A	4	6 741	134	10 349
	HSH-CDY-44108A	5	7 817	158	11 264
	HSH-CDY-44136A	6 1/2	9 791	200	13 965
	HSH-CDG-1014A	1/2	1 399	20	4 545
	HSH-CDG-1016A	5/8	1 608	22	4 709
	HSH-CDG-2018A	3/4	2 510	38	5 736
	HSH-CDG-2024A	1	2 902	46	6 109
	HSH-CDG-2026A	1 1/4	3 242	54	6 354
	HSH-CDG-3034A	1 1/2	4 056	71	6 939
	HSH-CDG-3038A	1 3/4	4 360	77	8 093
	HSH-CDG-3048A	2	6 160	116	8 926
	HSH-CDG-4054A	2 1/4	6 833	132	9 426
	HSH-CDG-4060A	3	7 652	149	10 259
HSH-CDG-4068A	3 1/2	8 371	164	11 012	

CLIENT360  
client360.intarcon.com  
SOFTWARE DE CÁLCULO FRIGORÍFICO



## Equipos para bodegas, queso y mini secaderos

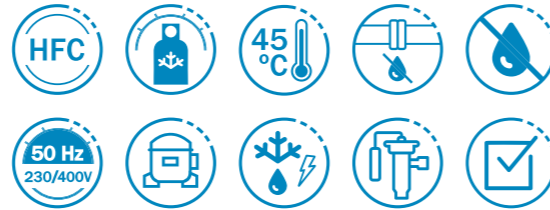

Equipos para acondicionamiento de bodegas, en construcción semicompacta con unidad motocondensadora silenciosa o centrífuga y unidad evaporadora de tipo plafón con doble flujo de aire, dotada de resistencias de calentamiento, sistema de humidificación / deshumidificación, bomba de condensados, y en construcción compacta de techo, con condensación axial o centrífuga.

### APLICACIONES

- Conservación de vino embotellado.
- Refrigeración de recintos a alta temperatura con humedad controlada.
- Conservación de vino en barricas.
- Curación de quesos.
- Minisecaderos de embutidos.
- Conservación de tabaco.

### ESQUEMA DE INSTALACIÓN

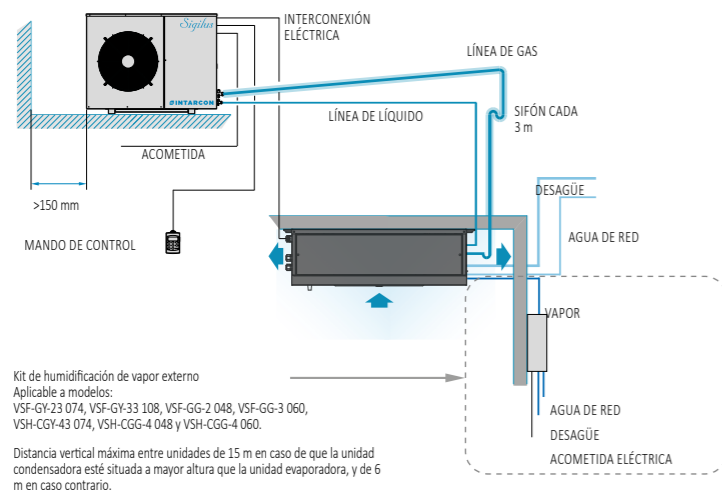

### Conservación de vino embotellado

El vino embotellado requiere condiciones controladas tanto de temperatura como de humedad que conserven de forma óptima el producto a la vez que eviten tanto el secado del corcho como el enmohecimiento de las etiquetas. Los equipos de tratamiento de vinos garantizan condiciones óptimas de conservación de vino embotellado.



### Conservación de vino en barrica

En la conservación del vino en barricas tiene una gran importancia la humedad relativa en el interior de la bodega, la cual debe estar ajustada para que no se produzca trasvase de vapor de agua entre el exterior de la bodega y el interior de la barrica, evitando así mermas de vino o absorción de agua por parte del contenido.

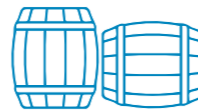

### Kit de humidificación de vapor externo

Humidificación a vapor de 3 kg/h de capacidad, compuesto por: lanzas de vapor integradas en la unidad evaporadora, un cilindro generador de electrodos sumergidos con válvulas de alimentación y purga de agua.



### Interconexiones eléctricas

Para la interconexión de las unidades condensadora y evaporadora se han de prever las siguientes secciones de cable para 10 m de longitud:

Tensión	230V 50Hz	400V 3N 50Hz
Sondas	4 x 1 mm <sup>2</sup>	
Maniobra	10 x 1 mm <sup>2</sup>	
Resis. Calefacción	2 x 2,5 mm <sup>2</sup> + T	4 x 1,5 mm <sup>2</sup> + T
Mando	2 x 1 mm <sup>2</sup>	
Humidificador	2 x 1 mm <sup>2</sup>	

### ESPECIFICACIONES TÉCNICAS

Evaporador de plafón de doble flujo de aire con resistencias de calentamiento y sistema de humidificación / deshumidificación; baterías de evaporación con recubrimiento anticorrosión.	
Desescarche por aire; filtro de aire.	
Válvula solenoide y válvula de expansión termostática integradas en el evaporador.	
Bandeja de condensados y bomba de condensados.	
Conexiones de tipo Flare (hasta 1/2"-3/4") y válvulas de servicio.	
Recipiente de líquido con precarga de refrigerante para hasta 10 m de tubería.	
Control de condensación proporcional (series VSF 1/2/3 y VSH 4/43) y control de condensación todo / nada (series VSF 0 y VSH 1, 2/22 y 3/33).	
Regulación electrónica multifunción con control de temperatura / humedad, y mando a distancia.	
Protección magnetotérmica.	
Cambio a alimentación 400V 3N 50Hz.	+ 5 %
Control de condensación proporcional por variación de velocidad (incluido en VSF serie 1/2/3 y VSH 4/43).	+ 327 €
Separador de aceite.	+ 768 €
Recubrimiento anticorrosión de batería del condensador.	+ 4 %
Rejilla exterior de protección de la batería.	+ 121 €

De serie Opcional

230V I+N ~ 50Hz / 400V 3N ~ 50Hz | Media temperatura - Bodegas | Compresor hermético | R-134a / R-449A

Refrigerante	Serie / Modelo	Alimentación	Compresor (CV)	Volumen bodega (m <sup>3</sup> )		Potencia frigorífica a 15 °C 70 % HR (W) <sup>(1)</sup>	Potencia calorífica (W)	Potencia absorb. nominal (W) <sup>(2)</sup>	Potencia absorb. nominal (W) <sup>(3)</sup>	Intens. máx. absorb. (A)	Caudal evap. (m <sup>3</sup> /h)	Caudal cond. (m <sup>3</sup> /h)	Conexión frigorífica Liq - Gas	Carga refrig. (kg) <sup>(4)</sup>	Peso (kg)	SPL dB(A) <sup>(5)</sup>	PVP (€)
				Sin aislar	Aislada												
R-134a	VSF-GY-00010A	230V I+N ~ 50Hz	3/8	11	37	1 242	1 000	1 520	520	8,8	500	350	1/4"-3/8"	< 1,5	46+30	28	6 816
	VSF-GY-10015A	230V I+N ~ 50Hz	1/2	20	53	1 820	1 000	1 670	670	10,1	500	1 700	1/4"-1/2"	< 2,0	57+30	34	7 769
	VSF-GY-11033A	230V I+N ~ 50Hz	1	47	100	3 281	1 500	2 760	1 260	16,3	1 100	1 700	1/4"-5/8"	< 2,5	67+35	34	9 351
	VSF-GY-12053A	230V I+N ~ 50Hz*	1 1/2	74	168	4 683	3 000	4 930	1 930	26,1	1 800	3 200	3/8"-3/4"	< 3,5	77+47	35	11 579
	VSF-GY-23074A <sup>(6)</sup>	230V I+N ~ 50Hz*	2	149	297	7 497	6 000	8 600	2 600	43,7	3 150	3 700	3/8"-3/4"	< 5,5	79+75	34	15 270
VSF-GY-33108A <sup>(6)</sup>	400V 3N ~ 50Hz	5	224	444	9 944	6 000	9 500	3 500	26,1	3 150	4 000	3/8"-7/8"	< 6,0	98+75	35	17 880	
R-449A	VSF-GG-0008A	230V I+N ~ 50Hz	1/3	10	35	1 227	1 000	1 160	480	8,4	500	350	1/4"-3/8"	< 1,5	48+30	28	6 425
	VSF-GG-1014A	230V I+N ~ 50Hz	1/2	24	60	2 134	1 500	2 550	1 050	13,5	1 100	1 700	1/4"-1/2"	< 2,5	59+35	34	7 321
	VSF-GG-1024A	230V I+N ~ 50Hz	1	47	100	3 388	3 000	4 810	1 810	24,9	1 800	1 700	3/8"-5/8"	< 4,0	82+47	34	8 813
	VSF-GG-1034A	230V I+N ~ 50Hz*	1 1/2	75	170	4 944	3 000	5 550	2 550	29,9	1 800	3 200	3/8"-5/8"	< 4,0	83+47	35	10 307
	VSF-GG-2048A <sup>(6)</sup>	400V 3N ~ 50Hz	2	151	300	7 830	6 000	9 190	3 190	17,9	3 150	3 700	1/2"-3/4"	< 5,5	84+75	26	13 925
VSF-GG-3060A <sup>(6)</sup>	400V 3N ~ 50Hz	3	221	450	10 490	6 000	10 870	4 870	19,5	5 200	6 500	1/2"-7/8"	< 6,5	88+140	26	15 914	

### DIMENSIONES

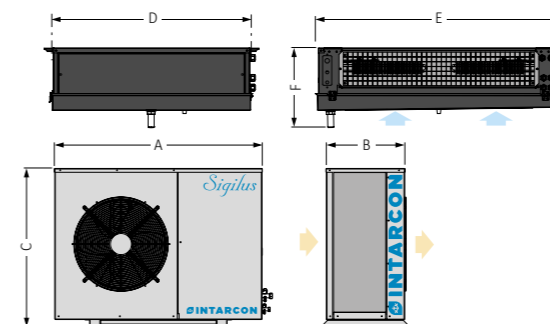

Dimensiones (mm)	A	B	C	D	E	F	Ventiladores evaporador
Serie 0 y 00	671	308	442	764	653	207	1x Ø 254
VSF-GY-10015A	1 030	380	577	764	653	207	1x Ø 254
Serie 11 y VSF-GG-1014A	1 030	380	577	886	728	312	1x Ø 360
Serie 12, VSF-GG-1024A y 1034A	1 030	380	577	886	1 079	312	2x Ø 360
Serie 2 y 23	1 080	416	827	886	1 803	312	3x Ø 360
VSF-GY-33108A	1 150	487	1 097	886	1 803	312	3x Ø 360
VSF-GG-3060A	1 150	487	1 097	976	2 203	362	3x Ø 450

<sup>(1)</sup> Las prest. nominales están referidas al funcionamiento con temp. de cámara de 15 °C, humedad relativa de cámara del 70 % y temp. exterior de 35 °C. Volumen de cámara para hostelería estimado sin aislar y volumen de bodega estimado con aislamiento de 30 mm. Para otras aplicaciones consultar.  
<sup>(2)</sup> Potencia abs. nominal en modo de deshumectación.  
<sup>(3)</sup> Potencia absorbida nominal en modo de refrigeración.  
<sup>(4)</sup> Equipos con carga inferior a 5 toneladas de CO<sub>2</sub> equivalente (3,5 kg de R-134a o R-449A) exentos de comprobación de fugas (RD 552/2019).  
<sup>(5)</sup> Nivel de presión sonora en campo libre, con directividad 1, medido a 10 m de la fuente (valor no vinculante calculado a partir de la potencia sonora).  
<sup>(6)</sup> Unidades disponibles en tensión 400V 3N 50Hz.  
<sup>(7)</sup> Incluyen de serie el kit de humidificación de vapor externo.

### Versión centrífuga

	Serie / Modelo Centrifugo	CV	Caudal cond. (m <sup>3</sup> /h)	PED (Pa) <sup>(6)</sup>	PVP (€)
R-134a	VSH-CGY-10010A	3/8	575	80	6 213
	VSH-CGY-21015A	1/2	1 000	120	7 769
	VSH-CGY-22033A	1	1 000	120	9 351
	VSH-CGY-33053A	1 1/2	1 500	140	11 579
R-449A	VSH-CGY-43074A <sup>(6)</sup>	2	3 500	100	15 270
	VSH-CGG-2014A	1/2	1 000	120	7 321
	VSH-CGG-2024A	1	1 000	120	8 813
	VSH-CGG-3034A	1 1/2	1 500	140	10 307
	VSH-CGG-4048A <sup>(6)</sup>	2	3 500	100	13 925
	VSH-CGG-4060A <sup>(6)</sup>	3	3 500	100	15 914

230V I+N ~ 50Hz / 400V 3N ~ 50Hz | Media temperatura | Compresor hermético | R-134a / R-449A

Refrigerante	Serie / Modelo Axial	Alimentación	Compresor (CV)	Potencia frigorífica / Volumen cámara, según temperatura de cámara (1)								Potencia absorb. nominal (W)	Intens. máx. absorb. (A)	Caudal evapo. (m³/h)	Conexión frigorífica Liq-Gas	Carga refrig. (kg) (2)	Peso (kg)	SPL dB(A) (3)	PVP (€)	Serie / Modelo Centrifugo	Caudal cond. (m³/h)	PED (Pa) (4)	PVP (€)
				0 °C		5 °C		10 °C															
				W	m³	W	m³	W	m³														
R-134a	MSH-QY-30068A	400V 3N ~ 50Hz	3 1/2	3 854	54	4 646	59	5 513	84	2 000	12,0	2 100	1/4"-3/4"	< 4,0	74+43	37	6 792	MSH-CQY-30068A	1 500	14	7 536		
	MSH-QY-40086A	400V 3N ~ 50Hz	4	4 431	63	5 418	68	6 500	100	2 350	14,3	2 100	3/8"-7/8"	< 5,0	107+43	48	7 940	MSH-CQY-40086A	3 500	10	8 810		
	MSH-QY-41108A	400V 3N ~ 50Hz	5	5 324	71	6 500	80	7 775	110	2 770	17,3	2 700	3/8"-7/8"	< 5,0	109+56	45	8 818	MSH-CQY-41108A	3 500	10	9 789		
	MSH-QY-42136A	400V 3N ~ 50Hz	6 1/2	7 235	110	8 773	180	10 474	280	3 850	22,0	4 150	3/8"-1 1/8"	< 5,0	112+72	44	11 021	MSH-CQY-42136A	3 500	10	12 234		
	MSH-QY-53171A	400V 3N ~ 50Hz	8	7 830	135	9 535	185	11 520	300	4 250	24,1	5 200	3/8"-1 1/8"	< 5,0	162+89	50	12 782	MSH-CQY-53171A	3 600	10	14 087		
	MSH-QY-53215A	400V 3N ~ 50Hz	10	9 450	175	11 435	230	13 740	350	5 010	30,5	6 200	3/8"-1 1/8"	< 5,0	166+94	49	14 057	MSH-CQY-53215A	3 600	10	15 452		
R-449A	MSH-QG-30034A	230V I+N ~ 50Hz*	1 1/2	3 409	39	4 054	62	4 797	99	1 610	16,3	2 100	1/4"-5/8"	< 3,5	74+43	38	5 830	MSH-CQG-30034A	1 500	14	6 388		
	MSH-QG-30038A	400V 3N ~ 50Hz	1 3/4	3 647	46	4 301	70	5 063	110	1 790	7,1	2 100	1/4"-5/8"	< 3,5	71+43	40	6 130	MSH-CQG-30038A	1 500	14	6 708		
	MSH-QG-40048A	400V 3N ~ 50Hz	2	4 752	67	5 559	99	6 554	159	2 420	9,8	2 100	3/8"-3/4"	< 4,5	95+43	36	7 169	MSH-CQG-40048A	3 500	10	7 756		
	MSH-QG-40054A	400V 3N ~ 50Hz	2 1/2	5 203	76	6 060	113	7 106	178	2 610	10,3	2 100	3/8"-3/4"	< 5,0	96+43	36	7 644	MSH-CQG-40054A	3 500	10	8 239		
	MSH-QG-41060A	400V 3N ~ 50Hz	3	6 049	86	7 038	128	8 260	198	3 070	11,3	2 700	1/2"-3/4"	< 5,0	97+56	36	8 285	MSH-CQG-41060A	3 500	10	8 886		
	MSH-QG-41068A	400V 3N ~ 50Hz	3 1/2	6 545	113	7 581	163	8 866	253	3 440	12,3	2 700	1/2"-3/4"	< 5,0	98+56	35	9 953	MSH-CQG-41068A	3 500	10	10 583		
	MSH-QG-52086A	400V 3N ~ 50Hz	4	8 056	125	9 542	185	11 320	315	3 870	15,0	4 150	1/2"-7/8"	< 5,0	135+72	48	11 852	MSH-CQG-52086A	3 600	12	12 489		
	MSH-QG-52108A	400V 3N ~ 50Hz	5	9 386	160	11 011	220	12 991	375	4 900	18,0	4 150	1/2"-7/8"	< 7,0	157+72	45	12 353	MSH-CQG-52108A	3 600	12	12 991		
	MSH-QG-53136A	400V 3N ~ 50Hz	6 1/2	11 894	190	13 856	260	16 173	430	6 670	21,0	6 200	1/2"-1 1/8"	< 9,0	140+94	44	13 366	MSH-CQG-53136A	3 600	12	14 000		

230V I+N ~ 50Hz / 400V 3N ~ 50Hz | Baja temperatura | Compresor hermético | R-449A / R-452A

Refrigerante	Serie / Modelo Axial	Alimentación	Compresor (CV)	Potencia frigorífica / Volumen cámara, según temperatura de cámara (1)						Potencia absorb. nominal (W)	Intens. máx. absorb. (A)	Caudal evapo. (m³/h)	Conexión frigorífica Liq-Gas	Carga refrig. (kg) (2)	Peso (kg)	SPL dB(A) (3)	PVP (€)	Serie / Modelo Centrifugo	Caudal cond. (m³/h)	PED (Pa) (4)	PVP (€)
				-25 °C		-20 °C		-15 °C													
				W	m³	W	m³	W	m³												
R-452A	BSH-QG-30075A	230V I+N ~ 50Hz*	2 1/2	1 765	14	2 425	27	3 050	47	2 300	25,1	2 100	1/4"-5/8"	< 3,5	85+43	44	6 488	BSH-CQG-30075A	1 500	14	6 852
	BSH-QB-30096A	400V 3N ~ 50Hz	3 1/2	2 223	22	2 869	36	3 491	61	2 390	11,2	2 100	3/8"-3/4"	< 3,5	85+43	49	7 214	BSH-CQB-30096A	1 500	14	7 878
	BSH-QB-41108A	400V 3N ~ 50Hz	4	2 658	34	3 626	58	4 688	99	2 960	14,4	2 700	3/8"-7/8"	< 5,0	107+56	47	9 399	BSH-CQB-41108A	3 500	10	10 048
	BSH-QB-42136A	400V 3N ~ 50Hz	5	3 915	51	5 021	85	5 999	144	4 290	17,3	4 150	3/8"-7/8"	< 5,0	107+72	42	11 218	BSH-CQB-42136A	3 500	10	11 895
	BSH-QB-53215A	400V 3N ~ 50Hz	7 1/2	5 428	80	7 186	120	8 842	200	6 280	25,0	5 200	1/2"-1 1/8"	< 7,0	166+89	49	14 679	BSH-CQB-53215A	3 600	12	15 356
	BSH-QB-53271A	400V 3N ~ 50Hz	10	6 972	110	8 858	150	10 712	220	7 950	30,0	6 200	1/2"-1 1/8"	< 7,5	166+94	49	15 466	BSH-CQB-53271A	3 600	12	16 141

DIMENSIONES

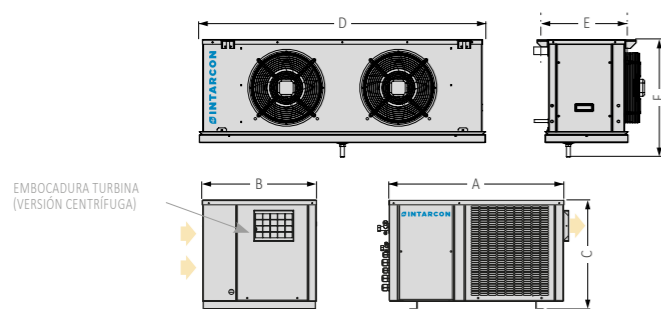

Dimensiones (mm)	A	B	C	D	E	F	Ventiladores evaporador	Embocadura turbina
Serie 30	925	580	515	880	455	581	1x Ø 350	266 x 236
Serie 40	1 000	615	585	880	455	581	1x Ø 350	305 x 266
Serie 41	1 000	615	585	1 230	455	581	1x Ø 350	305 x 266
Serie 42	1 000	615	585	1 530	455	581	2x Ø 350	305 x 266
Serie 52	1 289	757	657	1 530	455	581	2x Ø 350	305 x 266
MSH-QY-53171A BSH-QG-53215A	1 289	755	657	1 930	455	581	2x Ø 350	305 x 266
Serie 53	1 289	755	657	1 930	455	581	3x Ø 350	305 x 266
Serie 54	1 289	755	657	2 430	455	581	4x Ø 350	305 x 266

(1) Las prestaciones nominales están referidas al funcionamiento con temperatura de cámara de 0 °C (MT) y -20 °C (BT), y temperatura exterior de 35 °C. (2) Equipos con carga inferior a 5 toneladas de CO<sub>2</sub> equivalente (3,5 kg de R-134a o R-449A) exentos de comprobación de fugas (RD 552/2019).

(3) Nivel de presión sonora en campo libre, con directividad 1, medido a 10 m de la fuente (valor no vinculante calculado a partir de la potencia sonora).

(4) Presión estática disponible de condensación.

\* Unidades disponibles en tensión 400V 3N 50Hz.

Interconexiones eléctricas para 10 m de cable

Tensión	230V 50Hz	400V 3N 50Hz
Sondas	4 x 1 mm <sup>2</sup>	
Maniobra	2 x 1 mm <sup>2</sup>	3 x 1 mm <sup>2</sup>
Desescarche	2 x 1,5 mm <sup>2</sup> + T	4 x 1,5 mm <sup>2</sup> + T
Mando	2 x 1 mm <sup>2</sup>	
Interruptor puerta	2 x 1 mm <sup>2</sup>	
Resist. de puerta	2 x 1 mm <sup>2</sup> en BT	
Luz cámara	2 x 1 mm <sup>2</sup> + T	

CLIENT360  
client360.intarcon.com  
SOFTWARE DE CÁLCULO FRIGORÍFICO



230V I+N ~ 50Hz / 400V 3N ~ 50Hz | Alta temperatura | Compresor hermético | R-134a / R-449A

Refrigerante	Serie / Modelo Axial	Alimentación	Compresor (CV)	Potencia frigorífica / Volumen cámara, según temperatura de cámara (1)						Potencia absorb. nominal (W)	Intens. máx. absorb. (A)	Caudal evapo. (m³/h)	Conexión frigorífica Liq-Gas	Carga refrig. (kg) (2)	Peso (kg)	SPL dB(A) (3)	PVP (€)	Serie / Modelo Centrifugo	Caudal cond. (m³/h)	PED (Pa) (4)	PVP (€)
				9 °C		12 °C		15 °C													
				W	m³	W	m³	W	m³												
R-134a	ASH-DY-11015A	230V I+N ~ 50Hz	1/2	1 555	14	1 733	19	1 928	26	750	5,9	1 100	1/4"-1/2"	< 2,0	48+32	32	4 127	ASH-CDY-11015A	575	80	4 576
	ASH-DY-11026A	230V I+N ~ 50Hz	3/4	1 985	18	2 221	24	2 462	33	990	9,6	1 100	1/4"-1/2"	< 2,0	51+32	30	4 460	ASH-CDY-11026A	575	80	4 949
	ASH-DY-11033A	230V I+N ~ 50Hz	1	2 378	22	2 636	29	2 903	40	1 370	9,8	1 100	1/4"-5/8"	< 2,0	51+32	33	5 005	ASH-CDY-11033A	575	80	5 556
	ASH-DY-22033A	230V I+N ~ 50Hz	1	2 961	28	3 329	38	3 717	51	1 300	10,7	1 800	1/4"-5/8"	< 2,5	54+45	34	5 496	ASH-CDY-22033A	1 000	120	6 096
	ASH-DY-22053A	230V I+N ~ 50Hz*	1 1/2	3 738	35	4 169	48	4 625	63	2 040	13,3	1 800	3/8"-3/4"	< 2,5	55+45	38	6 394	ASH-CDY-22053A	1 000	120	7 097
	ASH-DY-33053A	230V I+N ~ 50Hz*	1 1/2	4 211	42	4 709	56	5 234	76	2 050	13,6	3 150	3/8"-3/4"	< 4,0	74+65	39	6 769	ASH-CDY-33053A	1 500	140	7 517
	ASH-DY-33074A	230V I+N ~ 50Hz*	2	5 502	58	6 148	77	6 830	104	2 740	17,6	3 150	3/8"-3/4"	< 4,0	71+65	44	8 056	ASH-CDY-33074A	1 500	140	8 937
	ASH-DY-43086A	400V 3N ~ 50Hz	4	7 124	74	8 001	98	8 915	131	3 160	15,4	3 150	3/8"-7/8"	< 6,5	107+65	48	9 179	ASH-CDY-43086A	3 500	100	10 190
	ASH-DY-43108A	400V 3N ~ 50Hz	5	8 216	85	9 177	111	10 206	148	3 760	18,4	3 150	3/8"-7/8"	< 6,0	109+65	45	10 075	ASH-CDY-43108A	3 500	100	11 181
	ASH-DY-44108A	400V 3N ~ 50Hz	5	8 873	92	9 954	121	11 062	160	4 080	18,4	5 700	3/8"-7/8"	< 6,0	112+70	45	11 041	ASH-CDY-44108A	3 500	100	12 253
R-449A	ASH-DY-44136A	400V 3N ~ 50Hz	6 1/2	10 988	114	12 206	148	13 498	195	4 570	22,4	5 700	1/2"-1 1/8"	< 6,0	112+70	44	12 144	ASH-CDY-44136A	3 500	100	13 480
	ASH-DG-1010A	230V I+N ~ 50Hz	3/8	1 237	10	1 341	14	1 455	19	770	5,2	1 100	1/4"-3/8"	< 2,5	42+32	34	3 783	ASH-CDG-1010A	575	80	4 272
	ASH-DG-1012A	230V I+N ~ 50Hz	1/2	1 419	12	1 535	16	1 664	22	820	6,2	1 100	1/4"-3/8"	< 2,5	43+32	34	3 943	ASH-CDG-1012A	575	80	4 455
	ASH-DG-2014A	230V I+N ~ 50Hz	1/2	1 829	16	1 965	22	2 109	29	950	7,4	1 100	1/4"-1/2"	< 3,0	45+32	35	4 105	ASH-CDG-2014A	1 000	120	4 633
	ASH-DG-2016A	230V I+N ~ 50Hz	5/8	2 014	18	2 169	24	2 338	33	1 030	8,3	1 100	1/4"-1/2"	< 3,0	54+32	3					

230V I+N ~ 50Hz / 400V 3N ~ 50Hz | **Media temperatura** | Compresor hermético | R-134a / R-449A

Refrigerante	Serie / Modelo	Alimentación	Compresor (CV)	Potencia frigorífica / Volumen cámara, según temperatura de cámara (1)								Potencia absorb. nominal (W)	Intens. máx. absorb. (A)	Vent. evap.	Caudal evapo. (m³/h)	Caudal cond. (m³/h)	Conexión frigorífica Liq-Gas	Carga refrig. (kg) (2)	Peso (kg)	SPL dB(A) (3)	PVP (€)
				-5 °C		0 °C		5 °C		10 °C											
				W	m³	W	m³	W	m³	W	m³										
R-134a	MSF-QY-10068A	400V 3N ~ 50Hz	3 1/2	3 281	42	4 106	60	4 998	69	5 985	110	1 980	12,8	1x Ø 350	2 100	3 200	1/4"-3/4"	< 4,0	82+43	25	8 047
	MSF-QY-20086A	400V 3N ~ 50Hz	4	3 523	45	4 442	65	5 429	75	6 515	120	2 190	14,8	1x Ø 350	2 100	3 700	3/8"-7/8"	< 4,5	96+43	38	8 710
	MSF-QY-21108A	400V 3N ~ 50Hz	5	4 226	58	5 334	81	6 521	130	7 807	210	2 560	16,3	1x Ø 350	2 700	3 700	3/8"-7/8"	< 5,0	98+56	35	9 496
	MSF-QY-22136A	400V 3N ~ 50Hz	6 1/2	5 749	80	7 277	120	8 831	186	10 553	290	3 630	21,1	2x Ø 350	4 150	3 700	3/8"-1 1/8"	< 5,0	101+72	34	11 445
	MSF-QY-33171A	400V 3N ~ 50Hz	8	6 746	100	8 484	172	10 295	197	12 306	354	4 420	24,1	2x Ø 350	5 200	4 000	3/8"-1 1/8"	< 7,0	140+89	40	13 044
	MSF-QY-33215A	400V 3N ~ 50Hz	10	8 426	130	10 563	241	12 857	268	15 419	440	5 240	30,5	3x Ø 350	6 200	6 500	3/8"-1 1/8"	< 7,5	147+94	39	14 358
MSF-QY-34271A	400V 3N ~ 50Hz	13	11 099	165	13 776	256	16 622	346	19 777	550	7 190	40,2	4x Ø 350	8 300	6 500	1/2"-1 3/8"	< 8,5	152+118	38	18 181	
R-449A	MSF-QG-10038A	400V 3N ~ 50Hz	1 3/4	3 280	31	3 919	48	4 625	75	5 472	120	1 770	7,4	1x Ø 350	2 100	3 200	1/4"-5/8"	< 3,0	82+43	29	7 198
	MSF-QG-20048A	400V 3N ~ 50Hz	2	3 964	43	4 736	63	5 572	95	6 605	150	2 210	8,8	1x Ø 350	2 100	3 700	3/8"-3/4"	< 5,0	84+43	26	7 787
	MSF-QG-20054A	400V 3N ~ 50Hz	2 1/2	4 395	48	5 197	72	6 078	110	7 158	170	2 380	9,4	1x Ø 350	2 100	3 700	3/8"-3/4"	< 5,0	85+43	26	8 124
	MSF-QG-21060A	400V 3N ~ 50Hz	3	5 081	61	6 032	89	7 055	130	8 328	200	2 840	10,4	1x Ø 350	2 700	3 700	3/8"-3/4"	< 5,0	88+56	26	8 858
	MSF-QG-21068A	400V 3N ~ 50Hz	3 1/2	5 519	78	6 528	110	7 601	160	8 942	250	3 210	11,4	1x Ø 350	2 700	3 700	3/8"-3/4"	< 5,0	88+56	25	10 235
	MSF-QG-32086A	400V 3N ~ 50Hz	4	6 787	91	8 180	130	9 707	190	11 545	300	4 130	13,6	2x Ø 350	4 150	4 000	1/2"-7/8"	< 7,0	115+72	38	11 664
	MSF-QG-32108A	400V 3N ~ 50Hz	5	8 623	125	10 181	175	11 880	255	13 969	400	5 050	16,7	2x Ø 350	4 150	6 500	1/2"-7/8"	< 7,0	120+72	35	12 839
	MSF-QG-43136A	400V 3N ~ 50Hz	6 1/2	11 105	160	13 146	220	15 399	320	18 145	500	6 630	21,5	3x Ø 350	6 200	7 000	1/2"-1 1/8"	< 10,0	135+89	34	15 270
	MSF-QG-44160A	400V 3N ~ 50Hz	8	11 597	170	14 009	230	16 660	340	19 806	530	7 590	26,0	4x Ø 350	8 300	7 000	5/8"-1 1/8"	< 10,0	157+118	40	17 922

230V I+N ~ 50Hz / 400V 3N ~ 50Hz | **Baja temperatura** | Compresor hermético | R-449A / R-452A

Refrigerante	Serie / Modelo	Alimentación	Compresor (CV)	Potencia frigorífica / Volumen cámara, según temperatura de cámara (1)						Potencia absorb. nominal (W)	Intens. máx. absorb. (A)	Vent. evap.	Caudal evapo. (m³/h)	Caudal cond. (m³/h)	Conexión frigorífica Liq-Gas	Carga refrig. (kg) (2)	Peso (kg)	SPL dB(A) (3)	PVP (€)
				-25 °C		-20 °C		-15 °C											
				W	m³	W	m³	W	m³										
R-452A	BSF-QG-10075A	230V I+N ~ 50Hz*	2 1/2	1 760	14	2 465	27	3 110	48	2 300	25,1	1x Ø 350	2 100	1 700	1/4"-5/8"	< 3,0	90+43	37	7 055
	BSF-QB-20096A	400V 3N ~ 50Hz	3 1/2	2 409	20	3 125	43	3 864	74	2 410	11,5	1x Ø 350	2 100	3 700	3/8"-3/4"	< 4,0	97+43	39	9 603
	BSF-QB-21108A	400V 3N ~ 50Hz	4	2 739	28	3 751	50	4 831	86	2 790	13,5	1x Ø 350	2 700	3 700	3/8"-7/8"	< 5,0	97+56	37	10 338
	BSF-QB-22136A	400V 3N ~ 50Hz	5	3 866	53	5 001	83	6 060	130	4 110	16,4	2x Ø 350	4 150	3 700	1/2"-1 1/8"	< 5,0	97+72	32	12 296
	BSF-QB-33215A	400V 3N ~ 50Hz	7 1/2	5 230	80	7 169	130	9 368	200	5 630	25,8	3x Ø 350	6 200	6 500	1/2"-1 1/8"	< 7,5	147+94	39	15 540
	BSF-QB-34271A	400V 3N ~ 50Hz	10	7 407	120	9 595	185	11 634	230	7 300	28,2	4x Ø 350	8 300	6 500	1/2"-1 3/8"	< 8,5	147+118	39	17 404

DIMENSIONES

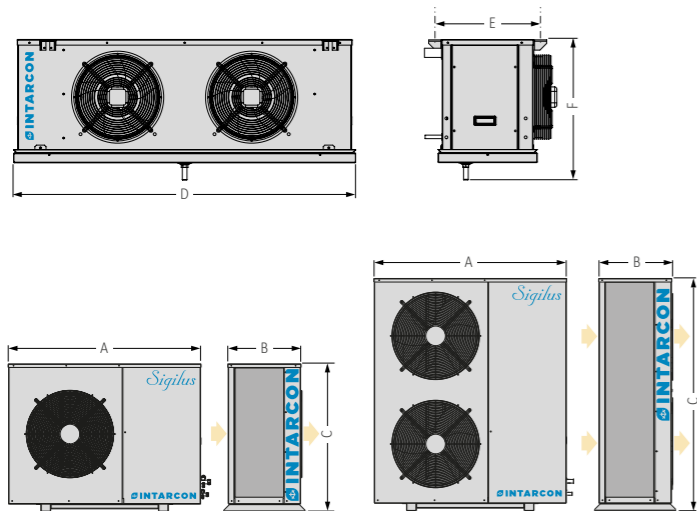

Dimensiones (mm)	A	B	C	D	E	F
Serie 10	1 030	380	577	880	455	581
Serie 20	1 080	416	827	880	455	581
Serie 21	1 080	416	827	1 230	455	581
Serie 22	1 080	416	827	1 530	455	581
Serie 32	1 150	487	1 097	1 530	455	581
Serie 33	1 150	487	1 097	1 930	455	581
Serie 34	1 150	487	1 097	2 430	455	581
Serie 43	1 150	487	1 346	1 930	455	581
Serie 44	1 150	487	1 346	2 430	455	581

(1) Las prestaciones nominales están referidas al funcionamiento con temperatura de cámara de 0 °C (MT) y -20 °C (BT), y temperatura exterior de 35 °C. Volumen de cámara estimado según condiciones de las bases de cálculo (pág. 12).  
 (2) Equipos con carga inferior a 5 toneladas de CO<sub>2</sub> equivalente (3,5 kg de R-134a o R-449A) exentos de comprobación de fugas (RD 552/2019).  
 (3) Nivel de presión sonora en campo libre, con directividad 1, medido a 10 m de la fuente (valor no vinculante calculado a partir de la potencia sonora).  
 \* Unidades disponibles en tensión 400V 3N 50Hz.

Interconexiones eléctricas

Para la interconexión de las unidades condensadora y evaporadora se han de prever las siguientes secciones de cable para 10 m de longitud:

Tensión	230V 50Hz	400V 3N 50Hz
Sondas	4 x 1 mm²	
Maniobra	2 x 1 mm²	3 x 1 mm²
Desescarche	2 x 1,5 mm² + T	4 x 1,5 mm² + T
Mando	2 x 1 mm²	
Interruptor puerta	2 x 1 mm²	
Resistencia de puerta	2 x 1 mm² en BT	
Luz cámara	2 x 1 mm² + T	

CLIENT360  
client360.intarcon.com  
SOFTWARE DE CÁLCULO FRIGORÍFICO



230V I+N ~ 50Hz / 400V 3N ~ 50Hz | **Alta temperatura** | Compresor hermético | R-134a / R-449A

Refrigerante	Serie / Modelo	Alimentación	Compresor (CV)	Potencia frigorífica / Volumen cámara, según temperatura de cámara (1)						Potencia absorb. nominal (W)	Intens. máx. absorb. (A)	Caudal evapo. (m³/h)	Caudal cond. (m³/h)	Conexión frigorífica Liq-Gas	Carga refrig. (kg) (2)	Peso (kg)	SPL dB(A) (3)	PVP (€)
				9 °C		12 °C		15 °C										
				W	m³	W	m³	W	m³									
R-134a	ASF-DY-11015A	230V I+N ~ 50Hz	1/2	1 687	16	1 922	21	2 160	29	690	4,7	1 100	1 700	1/4"-1/2"	< 2,5	57+32	34	4 767
	ASF-DY-11026A	230V I+N ~ 50Hz	3/4	2 342	23	2 678	30	2 977	41	1 050	8,4	1 100	1 700	1/4"-1/2"	< 2,5	65+32	34	5 107
	ASF-DY-12033A	230V I+N ~ 50Hz	1	2 840	27	3 176	36	3 533	48	1 330	10,4	1 800	1 700	1/4"-5/8"	< 3,0	67+45	34	5 749
	ASF-DY-13053A	230V I+N ~ 50Hz*	1 1/2	4 226	42	4 730	56	5 271	72	2 040	13,6	3 150	1 700	3/8"-3/4"	< 4,0	77+65	35	7 228
	ASF-DY-13074A	230V I+N ~ 50Hz*	2	6 053	62	6 825	83	7 634	112	2 610	17,6	3 150	3 200	3/8"-3/4"	< 4,5	79+65	34	8 400
	ASF-DY-23086A	400V 3N ~ 50Hz	4	7 151	75	8 033	99	8 957	131	2 900	14,4	3 150	3 700	3/8"-7/8"	< 5,0	96+65	38	9 399
	ASF-DY-24108A	400V 3N ~ 50Hz	5	8 936	99	10 028	122	11 146	165	3 800	17,5	5 700	3 700	3/8"-7/8"	< 5,5	98+70	35	10 423
	ASF-DY-24136A	400V 3N ~ 50Hz	6 1/2	11 093	128	12 332	168	13 645	224	5 000	21,2	5 700	3 700	1/2"-1 1/8"	< 6,0	98+70	34	13 305
	ASF-DY-34171A	400V 3N ~ 50Hz	8	13 424	146	14 989	186	16 669	251	5 880	25,2	5 700	6 500	1/2"-1 1/8"	< 6,0	120+70	40	15 823
	ASF-DY-44215A	400V 3N ~ 50Hz	10	15 771	171	17 593	218	19 546	294	6 610	30,2	5 700	7 000	1/2"-1 3/8"	< 9,0	120+70	39	17 401
R-449A	ASF-DG-1016A	230V I+N ~ 50Hz	5/8	2 161	19	2 387	25	2 635	35	990	7,5	1 100	1 700	1/4"-1/2"	< 2,5	67+32	38	4 558
	ASF-DG-1018A	230V I+N ~ 50Hz	3/4	2 462	23	2 709	30	2 961	42	1 180	8,8	1 100	1 700	1/4"-1/2"	< 2,5	68+32	35	4 885
	ASF-DG-1024A	230V I+N ~ 50Hz	1	3 225	29	3 539	39	3 879	51	1 530	11,3	1 800	1 700	3/8"-5/8"	< 3,5	82+45	34	5 497
	ASF-DG-1026A	230V I+N ~ 50Hz*	1 1/4	3 709	35	4 078	46	4 466	63	1 750	12,0	1 800	3 200	3/8"-5/8"	< 3,5	83+45	40	5 744
	ASF-DG-1034A	230V I+N ~ 50Hz*	1 1/2	4 607	43	5 046	58	5 494	77	2 240	16,6	1 800	3 200	3/8"-5/8"	< 3,5	83+45	39	6 522
	ASF-DG-1038A	400V 3N ~ 50Hz	1 3/4	5 393	52	5 885	68	6 410	91	2 200	7,8	3 150	3 200	3/8"-5/8"	< 4,0	82+65	29	7 377
	ASF-DG-2048A	400V 3N ~ 50Hz	2	6 722	67	7 343	87	7 962	115	2 760	9,3	3 150	3 700	1/2"-3/4"	< 5,5	84+65	26	8 166
	ASF-DG-2054A	400V 3N ~ 50Hz	2 1/2	7 447	75	8 113	97	8 793	130	3 000	9,8	3 150	3 700	1/2"-3/4"	< 5,5	85+65	26	8 488
	ASF-DG-3060A	400V 3N ~ 50Hz	3	8 824	94	9 673	115	10 551	155	3 600	11,9	3 150	6 500	1/2"-7/8"	< 6,0	88+65	26	9 409
	ASF-DG-3068A	400V 3N ~ 50Hz	3 1/2	9 662	98	10 578	125	11 512	165	4 190	12,9	3 150	6 500	1/2"-7/8"	< 6,0	88+65	25	11 087
ASF-DG-4086A	400V 3N ~ 50Hz	4	11 687	120	12 829	155	14 001	205	4 900	15,2	5 700	7 000	5/8"-1 1/8"	< 9,0	115+70	38	12 941	
ASF-DG-4108A	400V 3N ~ 50Hz	5	14 416	150	15 702	190	17 068	255	6 400	18,2	5 700	7 000	5/8"-1 1/8"	< 8,5	120+70	35	14 285	

DIMENSIONES

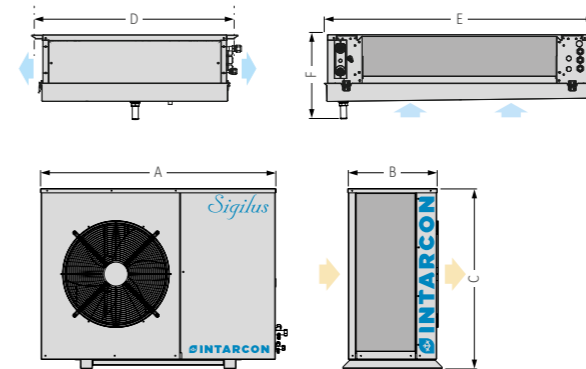

Dimensiones (mm)	A	B	C	D	E	F	Ventiladores evaporador
Serie 11	1 030	380	577	798	736	312	1

# Cubetas GN - GN containers

CUBETAS GASTRONORMA DE ACERO INOXIDABLE

STAINLESS STEEL GASTRONORM CONTAINERS

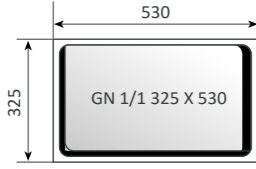
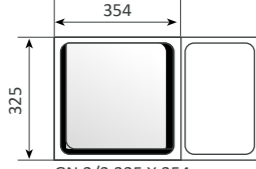
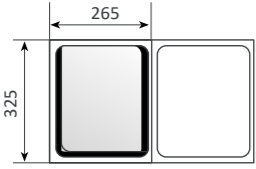
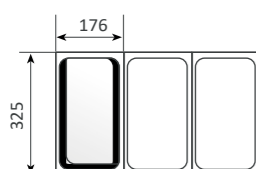
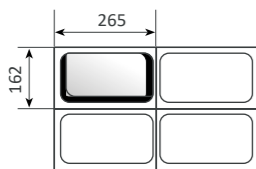
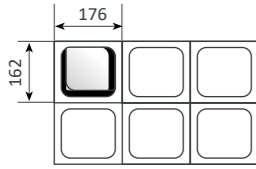
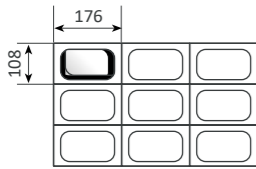

REF.	DESCRIPCIÓN DESCRIPTION	FONDO DEPTH	PRECIO PRICE (€)	
 <p>GN 1/1 325 X 530</p>	6041090031	GN 1/1-20	20 mm	25 €
	6041090032	GN 1/1-40	40 mm	29 €
	6041090024	GN 1/1-65	65 mm	32 €
	6041090014	GN 1/1-100	100 mm	39 €
	6041090013	GN 1/1-150	150 mm	65 €
	6041090033	GN 1/1-200	200 mm	75 €
 <p>GN 2/3 325 X 354</p>	6041090034	GN 2/3-20	20 mm	31 €
	6041090035	GN 2/3-40	40 mm	32 €
	6041090036	GN 2/3-65	65 mm	34 €
	6041090037	GN 2/3-100	100 mm	42 €
	6041090038	GN 2/3-150	150 mm	55 €
	6041090039	GN 2/3-200	200 mm	65 €
 <p>GN 1/2 325 X 265</p>	6041090040	GN 1/2-20	20 mm	21 €
	6041090041	GN 1/2-40	40 mm	21 €
	6041090006	GN 1/2-65	65 mm	22 €
	6041090022	GN 1/2-100	100 mm	30 €
	6041090017	GN 1/2-150	150 mm	42 €
	6041090042	GN 1/2-200	200 mm	51 €
 <p>GN 1/3 325 X 176</p>	6041090043	GN 1/3-20	20 mm	19 €
	6041090003	GN 1/3-40	40 mm	20 €
	6041090044	GN 1/3-65	65 mm	21 €
	6041090007	GN 1/3-100	100 mm	29 €
	6041090009	GN 1/3-150	150 mm	37 €
	6041090008	GN 1/3-200	200 mm	47 €
 <p>GN 1/4 162 X 265</p>	6041090045	GN 1/4-20	20 mm	19 €
	6041090010	GN 1/4-40	40 mm	21 €
	6041090046	GN 1/4-65	65 mm	21 €
	6041090018	GN 1/4-100	100 mm	28 €
	6041090021	GN 1/4-150	150 mm	34 €
	6041090047	GN 1/4-200	200 mm	43 €
 <p>GN 1/6 176 X 162</p>	6041090023	GN 1/6-65	65 mm	19 €
	6041090011	GN 1/6-100	100 mm	20 €
	6041090012	GN 1/6-150	150 mm	27 €
	6041090048	GN 1/6-200	200 mm	43 €
	<b>POLICARBONATO</b> 6041100024	<b>GN 1/6-150</b>	<b>150 mm</b>	<b>27 €</b>
 <p>GN 1/9 108 X 176</p>	6041090049	GN 1/9-65	65 mm	21 €
	6041090002	GN 1/9-100	100 mm	22 €

